

Index

Indice

SEATING

PRODUCT NAME NOME PRODOTTO	PAGE PAGINA
Arki-Stool	378
Babila	230
Babila XL	266
Blume	512
Buddy	310
Buddy Oasi	328
Buddyhub	340
Dome	754
Elinor	016
Ester	034
Folk	634
Gliss	468
Ila	564
Inga	588
Jazz	534
Laja	066
Log	720
Malmö	604
Modus	402
Nemea	772
Noa	434
Nolita Sofa	420
Nym	492
Osaka	646
Plural	680
Polar	004
Social	698
Temps	086
Tweet	280
Vic	550
Volt	738
Zippo	666

TABLES

PRODUCT NAME NOME PRODOTTO	PAGE PAGINA
Arki-Desk	188
Arki-Table	150
Babila	230
Buddyhub Desk	360
Elinor	016
Frank	052
Ikon	388
Kuadro	446
Malmö	604
Matrix	578
Rizz workstation	100
Toa	114
Togo	460
Ypsilon Tilting	206

LIGHTING & COMPLEMENTS

PRODUCT NAME NOME PRODOTTO	PAGE PAGINA
Boxie	198
Buddyhub sideboard	374
Diego	328
Flag	794
Giravolta	818
Hevea	140
Ray	786
Snooze	806
Toa Folding Screen	134
Ypsilon Connect	214

Polar

Engineering soul

DESIGN
Jorge Pensi Design Studio, 2022

EN — Polar is a task chair that ensures maximum customization in terms of ergonomics with its simple and intuitive built-in mechanisms. The backrest consists of an injected-moulded nylon frame with a breathable, flexible polyester mesh for a sense of transparency. A special mechanism allows the seat's depth to be adjusted. The chair guarantees excellent comfort thanks to its weight-activated, synchro-tilt mechanism that is able to regulate the degree of tilting autonomously according to the user's body weight.

IT — Polar è una seduta operativa che garantisce una massima personalizzazione in termini di ergonomia grazie alla presenza di meccanismi integrati semplici e intuitivi. Lo schienale è composto da una struttura in nylon stampato a iniezione alla quale viene fissata una rete in poliestere traspirante e flessibile, che dona trasparenza. Grazie ad un meccanismo che ne consente il movimento, è possibile regolare la profondità del sedile. Un moderno meccanismo sincronizzato autopesante, capace di regolare autonomamente l'intensità dell'oscillazione in funzione del peso corporeo dell'utente, garantisce inoltre a questa seduta operativa adattabilità ed estremo comfort.



WORKSPACE

Task armchair poltrona operativa Polar



Task armchair poltrona operativa Polar
Table tavolo Toa Workstation
Lighting lampada Giravolta
Desktop panel pannello divisorio da tavolo Toa Folding Screen



Task armchair poltrona operativa Polar
Table tavolo Toa Workstation
Lighting lampada Giravolta
Desktop panel pannello divisorio da tavolo Toa Folding Screen

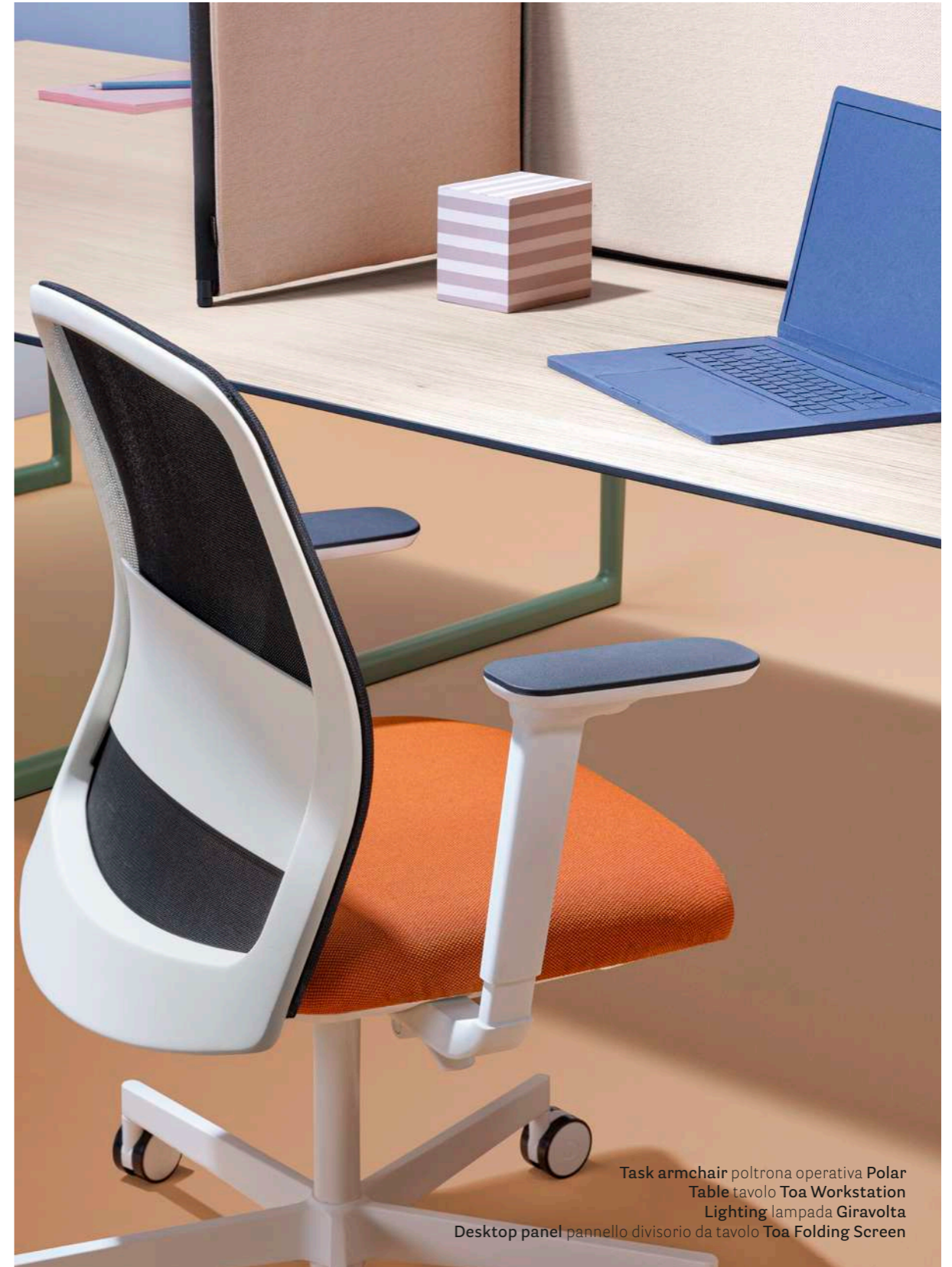

Task chair

Sedia operativa



Task armchair

Poltrona operativa







Pedrali collaborative space

Bergamo, Italy

Project: Headquarters

Architect: Park Associati

Products: Polar task armchair,
Arki-Table adj desk, Boxie storage
system, Buddyhub armchair

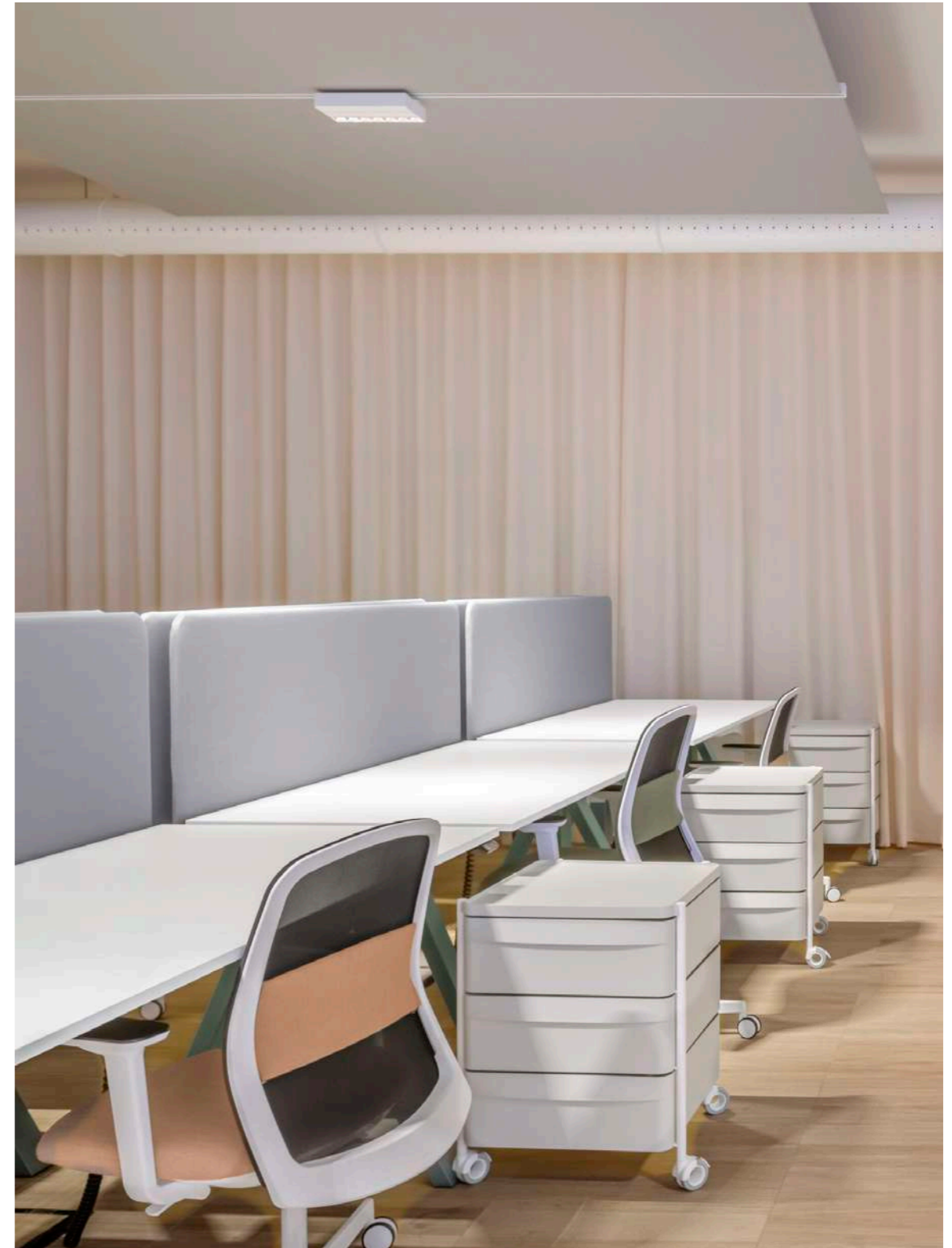



#PedraliWorkspaces

Orgatec 2022
Cologne, Germany

Project: Exhibition stand

Products: Polar task chair and task armchair,
Arki-Table adj desk, Boxie storage system

SIZES / DIMENSIONI

mm - in

3770

Task chair without armrests, die-cast aluminium five-spoke base with castors, polyurethane foam seat, nylon backrest with polyester mesh, polypropylene lumbar support, adjustable in height and depth



3771

Task chair without armrests, die-cast aluminium five-spoke base with castors, polyurethane foam seat, nylon backrest with polyester mesh, polypropylene lumbar support covered with the same fabric as the seat, adjustable in height and depth



3775

Task chair with adjustable armrests, die-cast aluminium five-spoke base with castors, polyurethane foam seat, nylon backrest with polyester mesh, polypropylene lumbar support, adjustable in height and depth



3776

Task chair with adjustable armrests, die-cast aluminium five-spoke base with castors, polyurethane foam seat, nylon backrest with polyester mesh, polypropylene lumbar support covered with the same fabric as the seat, adjustable in height and depth



FINISHES / FINITURE

powder coated / verniciato

polypropylene / polipropilene

fabrics / tessuti



BI200

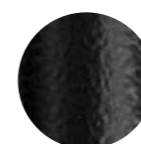

NERO



NE



BI

→ see booklet for finishes
vedi catalogo finiture

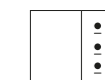

CERTIFICATES / CERTIFICAZIONI

Safety, strength and durability tests / Prove di sicurezza, resistenza e durata
EN 1728:2012+AC2013 — EN 1335-2:2018 — ANSI-BIFMA X5.1-2017

Elinor

A classy hug

DESIGN
Claudio Bellini, 2018

EN — The Elinor collection reflects different attitudes and approaches to workspaces, with a forward-looking perspective. It is dynamic, flexible and designed with essential yet distinctive visual styling. Strong points of Elinor are its comfort and body-hugging design, achieved through the polyurethane-injected foam seat and back. The table base consists of two moulded elements of fixed dimensions, made from rigid polyurethane foam and upholstered in genuine leather. These elements support an ultra-thin solid laminate tabletop, with a rounded lacquered MDF support beneath that conceals the steel structure.

IT — La collezione Elinor sintetizza le diverse attitudini e modalità di vivere l'ufficio del futuro. La seduta è dinamica, flessibile, con un design essenziale ma riconoscibile. I suoi punti di forza sono il comfort e l'avvolgenza dati dall'imbottitura in schiumato poliuretano di sedile e schienale. Il tavolo ha una base costituita da due elementi sagomati di dimensione fissa realizzati in poliuretano rigido e rivestiti in pelle che sostengono un ripiano in stratificato ultrasottile attraverso un sottopiano in MDF laccato dalla forma bombata, che nasconde la parte strutturale in acciaio.



WORKSPACE

Executive chair sedia esecutiva Elinor low back

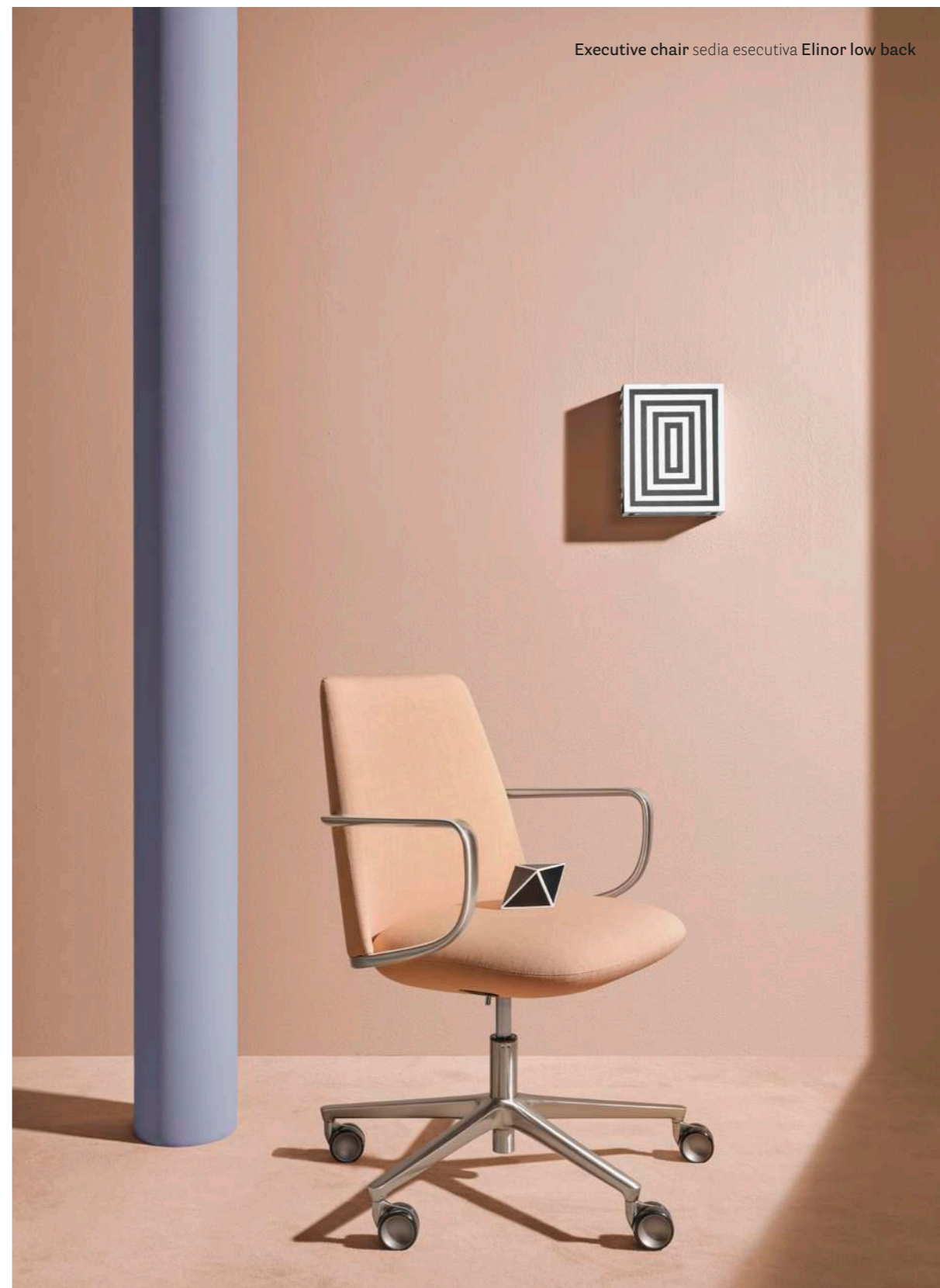

Executive chair high back

Sedia esecutiva schienale alto





Die-cast
aluminium
Pressofusione
di alluminio



Injected
polyurethane foam
Schiumato
poliuretano

Executive chair low back Sedia esecutiva schienale basso

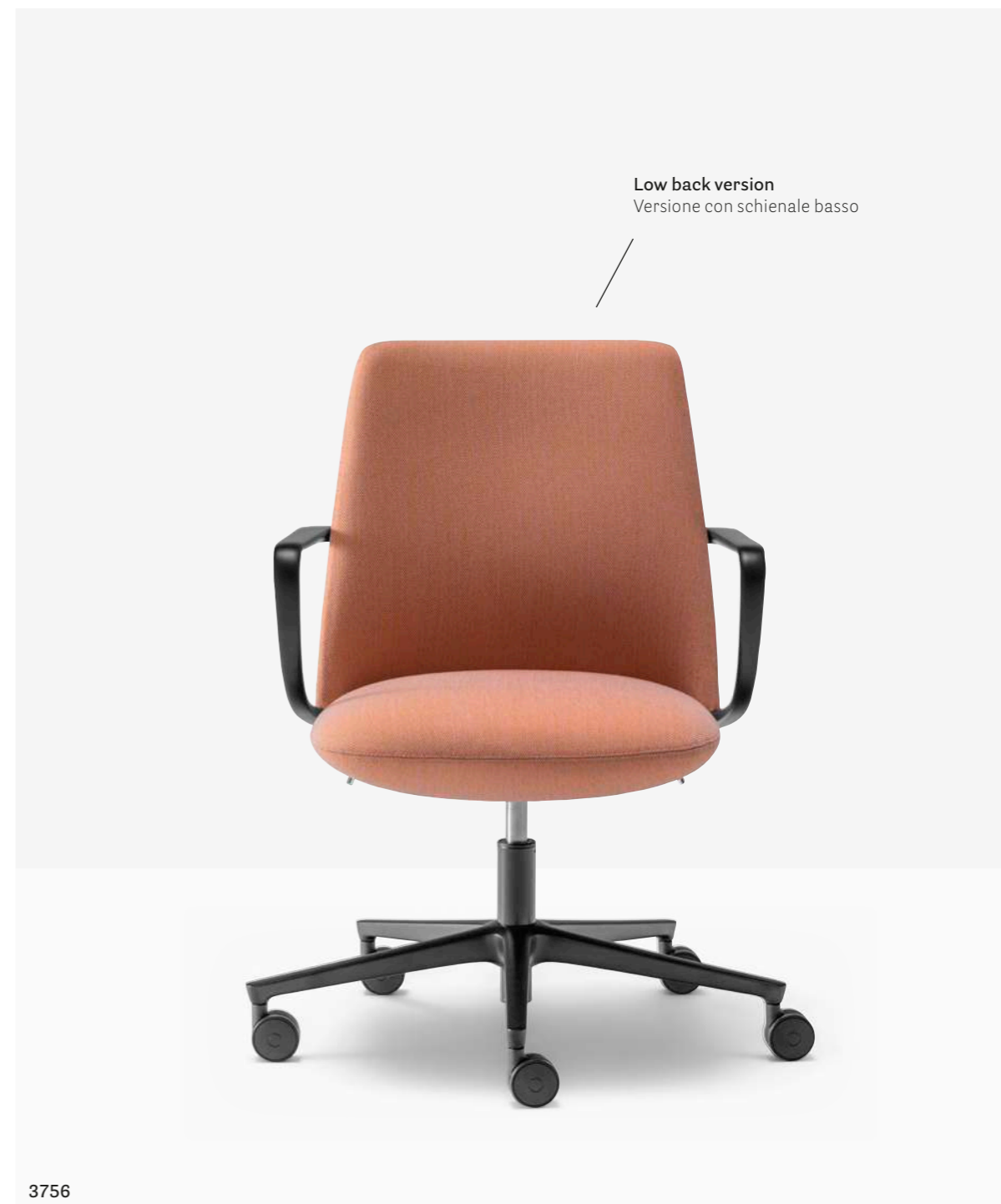

Low back version
Versione con schienale basso

3756



Die-cast aluminium base
Base in pressofusione di alluminio



Rigid polyurethane foam base,
upholstered in genuine leather
Base in poliuretano rigido
rivestite in vera pelle

ELN_150X150

Executive chair sedia esecutiva Elinor high back
Table tavolo Elinor table



Table

Tavolo





Pedrali Collaborative Space

Bergamo, Italy

Project: Headquarters

Architect: Park Associati

Products: Elinor low back executive chair and table, Ypsilon Connect space divider, Polar executive armchair, Arki-Table adjustable desk



deWol Industries hub

Milan, Italy

Project: Showroom

Architect: Isacco Brioschi Architects

Products: Elinor table, Laja armchair



Porsche Experience Center

Brescia, Italy

Project: Restaurant and office

Architect: gbpaarchitects

Products: Elinor executive
chair, Arki-Table

3755

Upholstered executive chair with high backrest, die-cast aluminium five-spoke base with castors, adjustable in height



3756

Upholstered executive chair with low backrest, die-cast aluminium five-spoke base with castors, adjustable in height



ELN150X150

Table, upholstered base, solid laminate or glass top



ELN200/260/300X110

Table, upholstered base, solid laminate or glass top

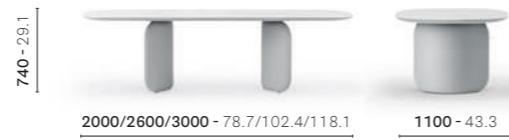

ELN150X150 CC60

Table, upholstered base, solid laminate or glass top, cable management (280x60 - 11.0x2.4)



ELN200/260/300X110 CC60

Table, upholstered base, solid laminate or glass top, cable management (540x60 - 21.3x2.4)



ELN150X150 CCO

Table, upholstered base, solid laminate or glass top, cable management (340x150 - 13.4x5.9)



ELN200/260/300X110 CCO

Table, upholstered base, solid laminate or glass top, cable management (600x150 - 23.6x5.9)



FINISHES / FINITURE

fabrics / tessuti

→ see booklet for finishes
vedi catalogo finiture

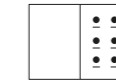

aluminium / alluminio



LU
Polished
Lucidato



ST
Satinized
Satinato

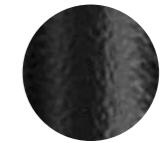

NERO

solid laminate top / ripiano in stratificato



CFP_BI



FNP3455*
Carrara Arabescato



527



234



623

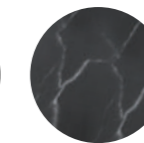

FNP3452*
Black Kandia

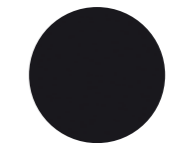

Fenix® Nero*

*Anti-fingerprint
Anti-impronta

shiny lacquered glass top / ripiano in vetro laccato lucido

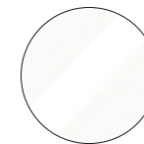

BIAL

AWARDS / PREMI



CERTIFICATES / CERTIFICAZIONI

Safety, strength and durability tests / Prove di sicurezza, resistenza e durata
EN 1728:2012+AC2013 — EN 1335-2:2018 — ANSI-BIFMA X5.1-2017

Ester

L'élégance de première classe

DESIGN

Patrick Jouin, 2013

EN — Ester is a mix of elegance, ergonomics and functionality: a precious monolith made of leather complemented by refined die-cast aluminum legs. Ester armchair with its soft and graceful lines, along with the great comfort offered by the seat made of polyurethane foam with elastic belts, distinguishes the interior of the most exclusive restaurants and hotels in the international scenario.

IT — Ester rappresenta la sintesi perfetta di eleganza, ergonomia e funzionalità: un prezioso monolito di pelle, completato dalla raffinata gamba in pressofusione d'alluminio. Le forme sinuose e morbide della poltrona Ester e l'assoluto comfort garantito da una seduta realizzata in schiumato poliuretano con cinghie elastiche, contribuiscono a caratterizzare gli spazi interni di ristoranti e hotel tra i più rappresentativi del panorama internazionale.



Armchair poltrona Ester
Table tavolo Exteso
Lighting lampada L002



Armchair poltrona Ester
Table tavolo Toa
Desktop Panel pannello divisorio da tavolo Toa Folding Screen
Lighting lampada Giravolta



Side chair
Sedia



Bag-rest pouf
Pouf poggia borsa



Injected foam with different density, elastic belts core
Schiumato poliuretano a densità variabile, anima con cinghie elastiche

Armchair

Poltrona



690



695

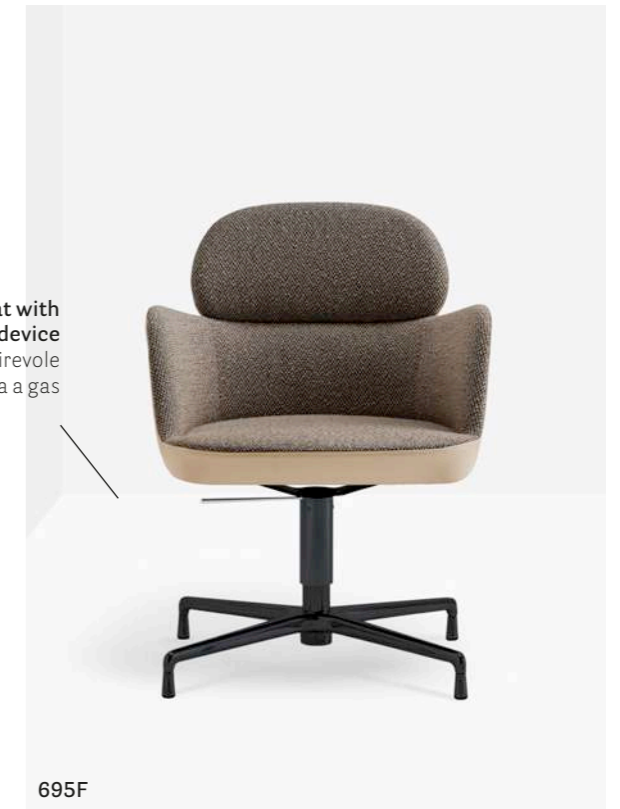

695F



High backrest version
Versione con schienale alto

Die-cast four-spoke aluminium base with castors
Base a quattro razze in pressofusione di alluminio con ruote

696



Die-cast aluminium legs
Gambe in pressofusione di alluminio

TOA240X90_CD

Barstool Sgabello

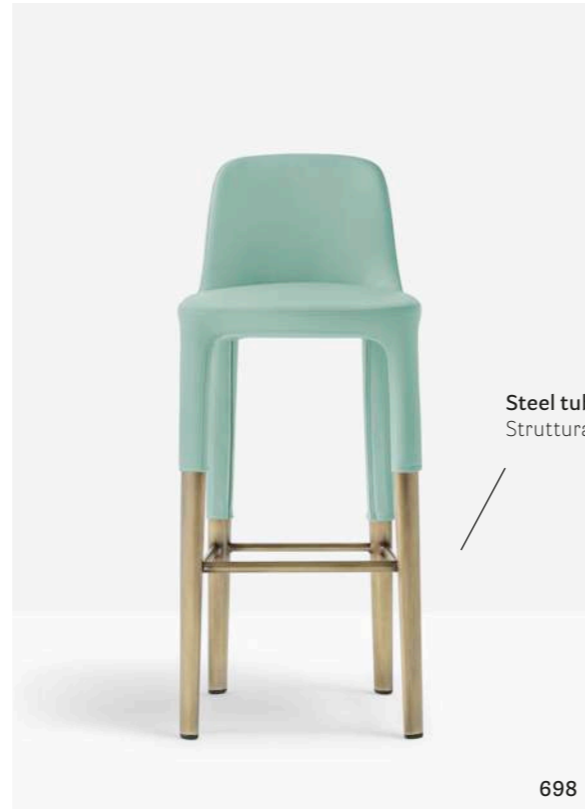

Steel tube legs
Struttura in acciaio

698



Fabric, leather
or simil-leather
covering
Rivestimento
in tessuto, vera
o finta pelle

698_H650

Lounge armchair Poltrona lounge



Lounge armchair in injected
polyurethane foam with
elastic belts and seat cushion.
Die-cast aluminium legs
Poltrona lounge in schiumato
poliuretano con cinghie
elastiche e cuscino imbottito.
Gambe in pressofusione di
alluminio

699

BRAZY Lisboa

Lisboa, Portugal

Project: Office
Architect: Zutto
Design e arquitectura
Products: Ester armchair,
Ila lounge armchair,
Caementum coffee
table

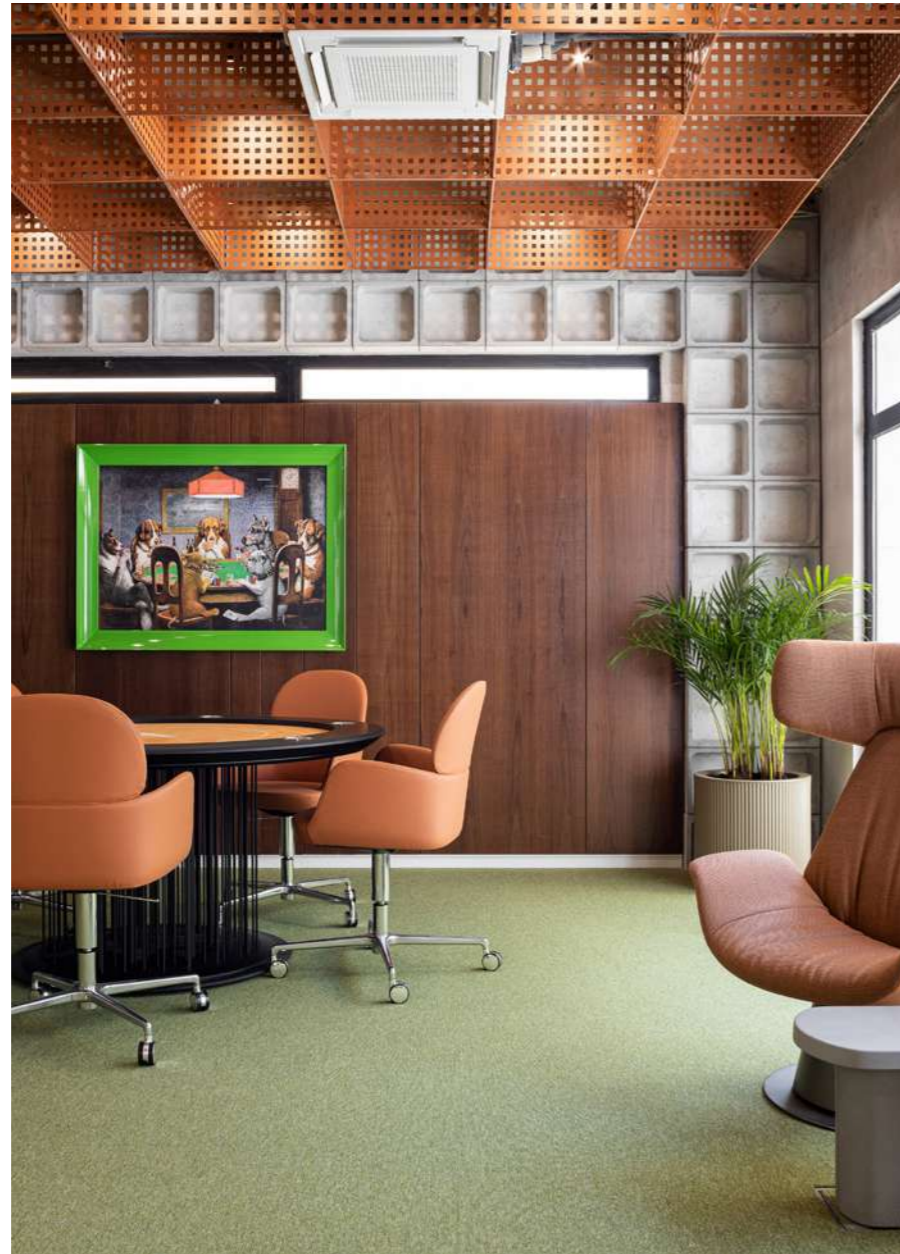

Chromavis Fareva

Cremona, Italy

Project: Office
Products: Ester armchair





Studio Nassini & Associati

Brescia, Italy

Project: Office

Products: Ester armchair
with swivel seat, Arki-Table



Minimal Apartment

Sofia, Bulgaria

Project: Home

Architect: IDEA International

Products: Ester armchair and barstool

691
Upholstered side chair,
die-cast aluminium legs



690
Upholstered armchair,
die-cast aluminium legs



693
Upholstered bag-rest pouf,
die-cast aluminium legs



695
Upholstered armchair, die-cast
four-spoke aluminium base with
castors, adjustable in height



696
Upholstered armchair with high backrest,
die-cast four-spoke aluminium base
with castors, adjustable in height



695F
Upholstered armchair, die-cast
four-spoke aluminium base,
adjustable in height



696F
Upholstered armchair with high backrest,
die-cast four-spoke aluminium base,
adjustable in height



698
Upholstered barstool,
steel tube legs



698_H650
Upholstered barstool,
steel tube legs



699
Upholstered side chair,
die-cast aluminium legs



FINISHES / FINITURE

fabrics / tessuti

→ see booklet for finishes
vedi catalogo finiture

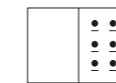

steel and aluminium / acciaio e alluminio

aluminium / alluminio

powder coated / verniciato



OA Antique brass
Ottone anticato
BS Brushed bronze
Bronzo satinato
AS Satinized
Satinato
TN Titanium
Titanio



LU* Polished
Lucidato
NERO*

* Only for four-spoke base version
Solo per versioni a quattro razze

AWARDS / PREMI



CERTIFICATES / CERTIFICAZIONI

Safety, strength and durability tests / Prove di sicurezza, resistenza e durata
EN 1728:2012+AC2013 — EN 16139:2013 level 2

Frank

Architectural illusion

DESIGN
Robin Rizzini, 2023

EN — Frank is a table inspired by architectural shapes and industrial materials. The structure on which the top rests is made up of two slightly curved die-cast aluminium bases with variable thickness. Seen from the front they are slightly arched and resemble the shape of a sail, creating a light and ethereal optical effect. Seen from the side, the volume appears full. Together, rational lines and curves contribute to conveying an image of lightness and contemporaneity.

IT — Frank è un tavolo ispirato da forme architettoniche e materiali industriali. La struttura su cui appoggia il ripiano è composta da due basi in pressofusione di alluminio dallo spessore variabile leggermente curvate. Viste frontalmente richiamano la forma di una vela che, leggermente inarcate creano un effetto ottico leggero ed etereo. Osservate lateralmente il loro volume appare pieno. Linee razionali e curve insieme contribuiscono a trasmettere un'immagine di leggerezza e contemporaneità al tempo stesso.





Table tavolo Frank
Armchair poltrona Laja 2
Lighting lampada To.Be
Space divider pannello divisorio Ypsilon Connect

WORKSPACE

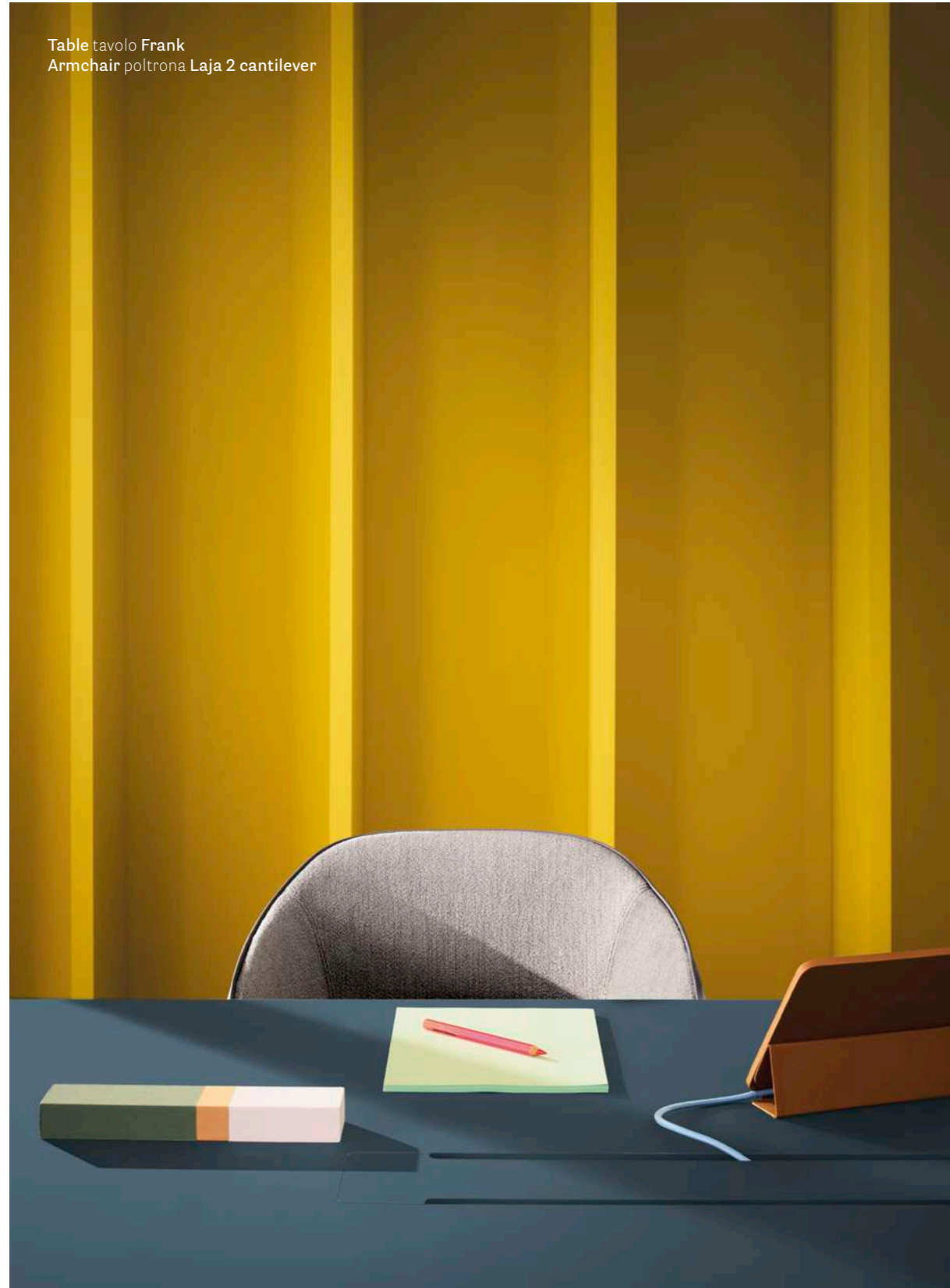

LIVING



Table

Tavolo



Soft-shaped top with rounded corners
Ripiano con angoli raggati dalle forme morbide

TABLE / TAVOLO



The die-cast aluminium bases are connected by a sturdy steel beam, placed under the top
Le basi in pressofusione di alluminio sono collegate da una robusta trave in acciaio posta sotto al ripiano



881/2

Top and bases available in honey, blue, green, beige and terracotta matte-coated Fenix®
Ripiano e basi disponibili in Fenix® verniciato opaco nelle colorazioni miele, blu, verde, beige e terracotta

Cable management system integrated into the tabletop
Canalina passacavi integrata sotto al ripiano

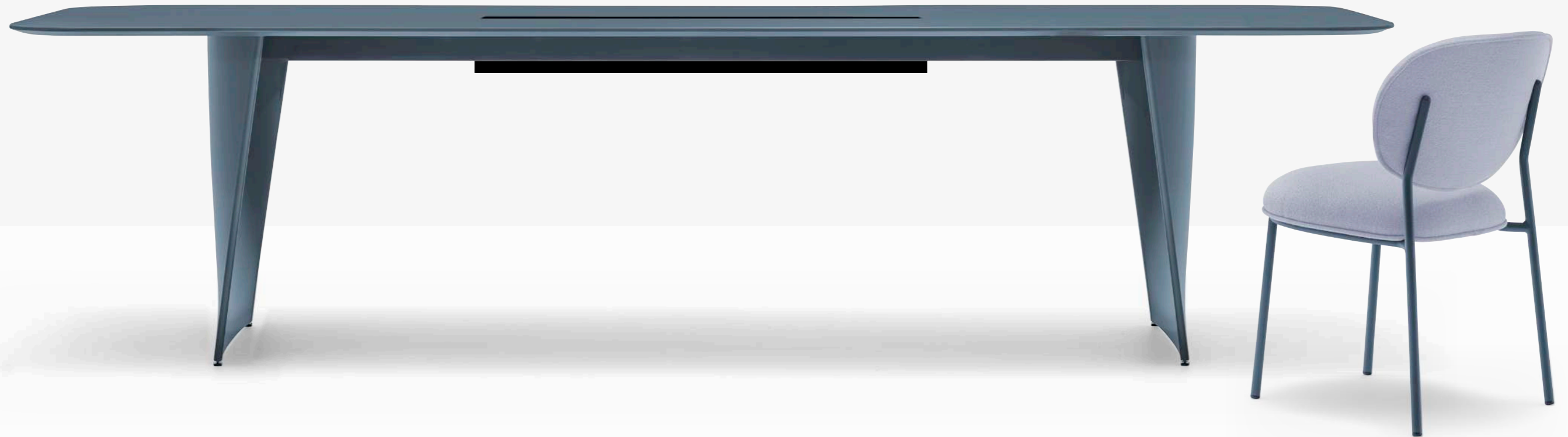

TFK300X110CC + 2960

#PedraliColoursofLightness

Salone del Mobile.Milano 2024
Milan, Italy

Project: Exhibition stand

Architect and Styling: DWA Design Studio

Products: Frank table, Stiel side chair and armchair, Tamara lighting



#PedraliBacktoNature

Salone del Mobile.Milano 2023
Milan, Italy

Project: Exhibition stand

Architect and Styling: DWA Design Studio

Products: Frank table, Lamorisse armchair,
Isotta lighting

TFK240X100

Table, die-cast aluminium bases, solid laminate, glass or glossy lacquered MDF top



TFK240X100 CC60

Table, die-cast aluminium bases, solid laminate, glass or glossy lacquered MDF top, cable management (1000x60 - 39.4x2.4)



TFK240X100 CCO

Table, die-cast aluminium bases, solid laminate, glass or glossy lacquered MDF top, cable management (600x132 - 23.6x5.2)



TFK300X110

Table, die-cast aluminium bases, solid laminate, glass or glossy lacquered MDF top



TFK300X110 CC60

Table, die-cast aluminium bases, solid laminate, glass or glossy lacquered MDF top, cable management (1000x60 - 39.4x2.4)



TFK300X110 CCO

Table, die-cast aluminium bases, solid laminate, glass or glossy lacquered MDF top, cable management (600x132 - 23.6x5.2)



TFK360X120

Table, die-cast aluminium bases, solid laminate, glass or glossy lacquered MDF top



TFK360X120 CC60

Table, die-cast aluminium bases, solid laminate, glass or glossy lacquered MDF top, cable management (1000x60 - 39.4x2.4)



TFK360X120 CCO

Table, die-cast aluminium bases, solid laminate, glass or glossy lacquered MDF top, cable management (600x132 - 23.6x5.2)



solid laminate top / ripiano in stratificato

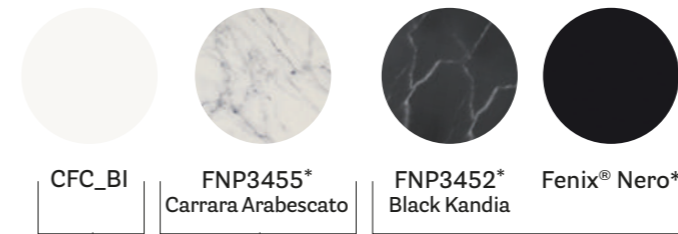

glossy lacquered MDF top
Ripiano MDF laccato lucido

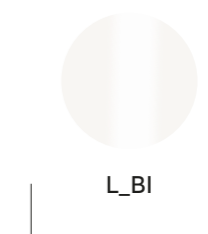

glass top
ripiano in vetro

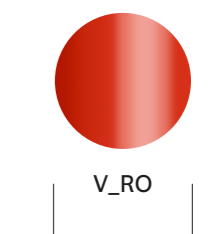

powder-coated legs / gambe in acciaio verniciato

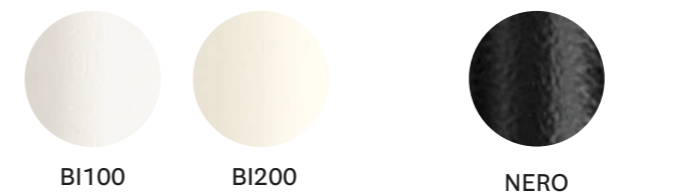

glossy powder coated legs / gambe verniciato lucido

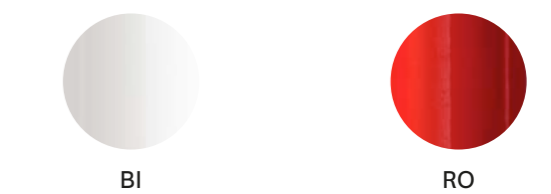

solid laminate top / ripiano in stratificato

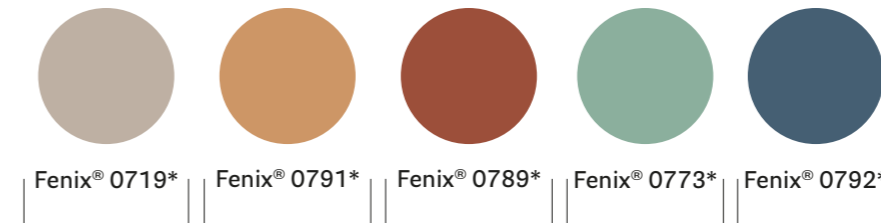

powder-coated legs / gambe in alluminio verniciato



AWARDS / PREMI



*Anti-fingerprint
Anti-impronta

Laja 2

A matter of details

DESIGN
Alessandro Busana, 2024

EN — Stylistic simplicity and organic shapes define Laja collection. A chair and armchair featured by an injected polyurethane foam seat with elastic belts, and a flexible, welcoming backrest. The distinguishing feature of the collection are the four die-cast aluminium legs, obtained from a single mould. The legs of Laja 2 are also available in solid ash wood, with a steel rod frame, a die-cast aluminium four-spoke base with castors or swivelling, or a cantilever steel tube frame. The armchairs with four legs in aluminium and solid ash wood can be equipped with a folding tablet suitable for training and conference rooms.

IT — La semplicità stilistica e le forme organiche definiscono la collezione Laja.

Una sedia e una poltrona caratterizzate da una seduta in schiumato poliuretano con cinghie elastiche e da uno schienale flessibile ed accogliente. L'aspetto distintivo della collezione sono le quattro gambe in pressofusione di alluminio, realizzate con un unico stampo. Le gambe sono disponibili anche in massello di frassino, in tondino d'acciaio a slitta, con base a quattro razze in pressofusione di alluminio con ruote o girevole e con struttura in tubo d'acciaio cantilever. Le poltrone con struttura a quattro gambe in alluminio e frassino risultano adatte anche per sale formazione e conferenze grazie all'aggiunta di una funzionale tavoletta reclinabile e removibile.



Side chair

Sedia

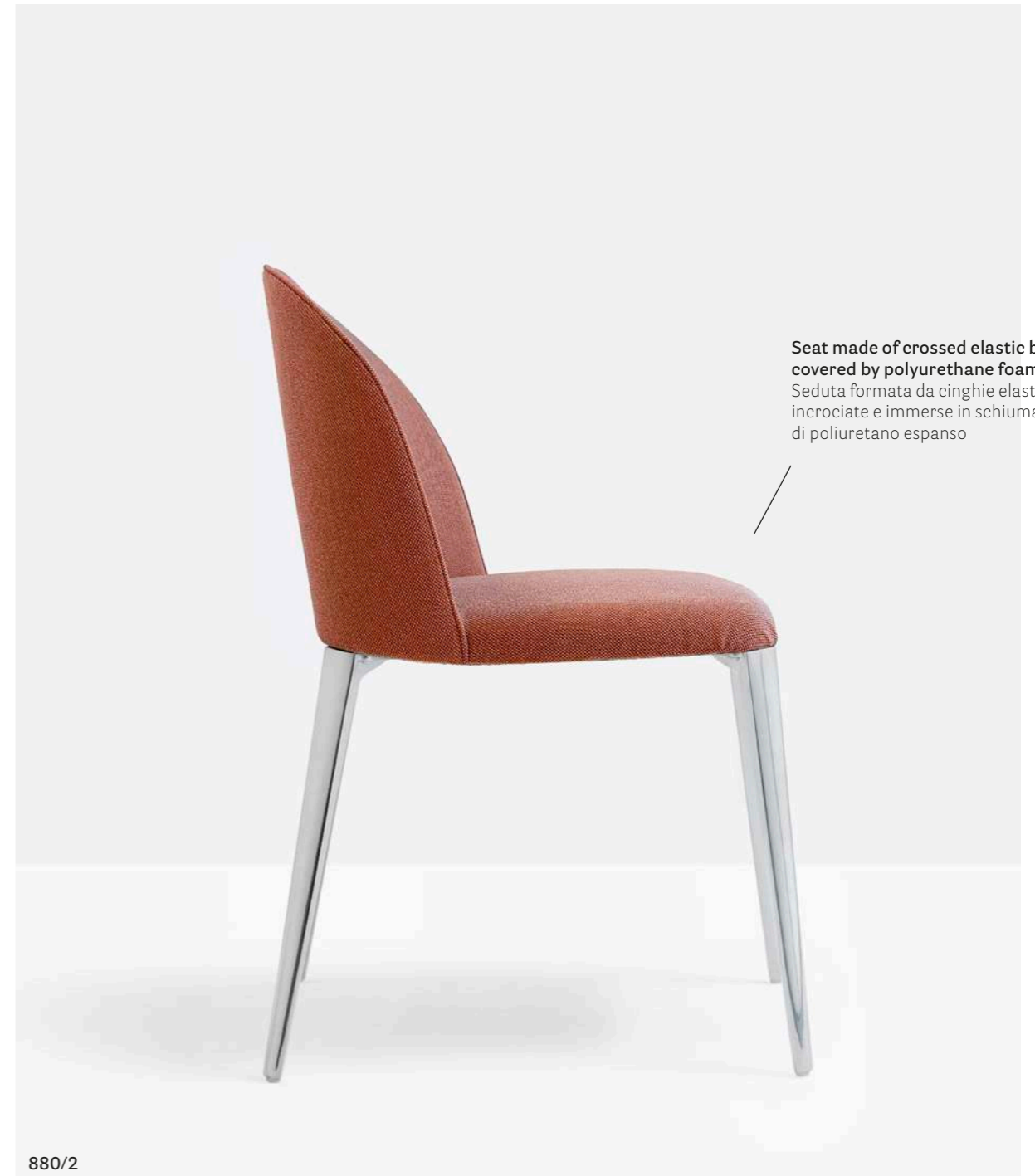

Seat made of crossed elastic belts covered by polyurethane foam
Seduta formata da cinghie elastiche incrociate e immerse in schiuma di poliuretano espanso

880/2

Armchair poltrona Laja 2



Armchair Poltrona

Cantilever version,
steel tube frame
Versione cantilever, struttura a
sbalzo in tubo d'acciaio
Ø 25 mm - Ø 0.98 in

882/2







Swivel seat, spring back device
Seduta girevole con meccanismo di ritorno automatico

887/2



Steel rod sled frame
Struttura a slitta in tondino d'acciaio Ø 12 mm - Ø 0.47 in

881/2



Fabric or leather covering
Rivestimento in pelle o tessuto

882/2

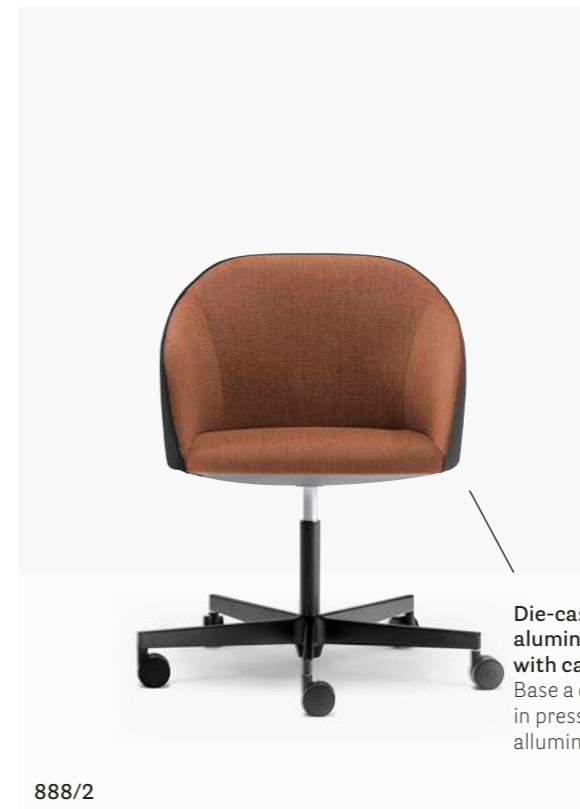

Die-cast five-spoke aluminium base with castors
Base a cinque razze in pressofusione di alluminio con ruote

888/2

Black Fenix® tablet
Tavoletta in Fenix® nero
300x265 mm - 11.8x10.4 in



885T/2

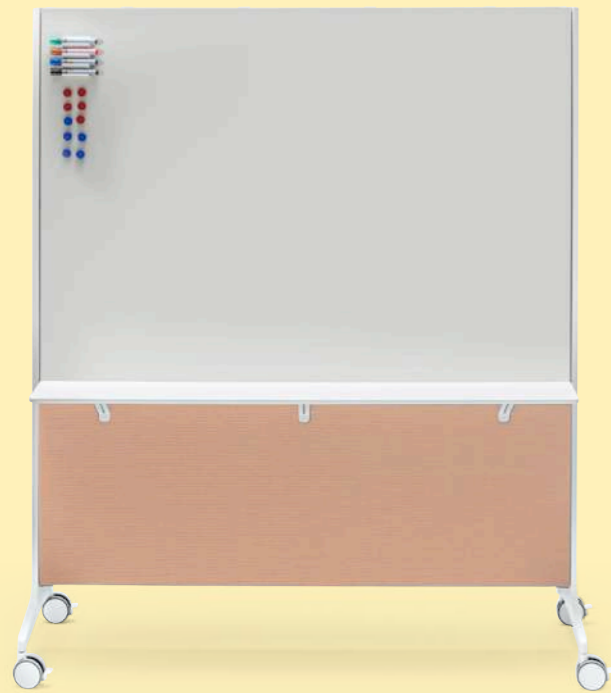

YCL_L150

**Steel structure covered
by polyurethane foam**
Struttura in acciaio
immersa in schiuma
di poliuretano espanso



Swiveling castors version
Versione con ruote piroettanti

889G

Studio legale Oberarzbacher e Steckholzer

Bolzano, Italy

Project: Office

Products: Laja armchair, Arki-Table

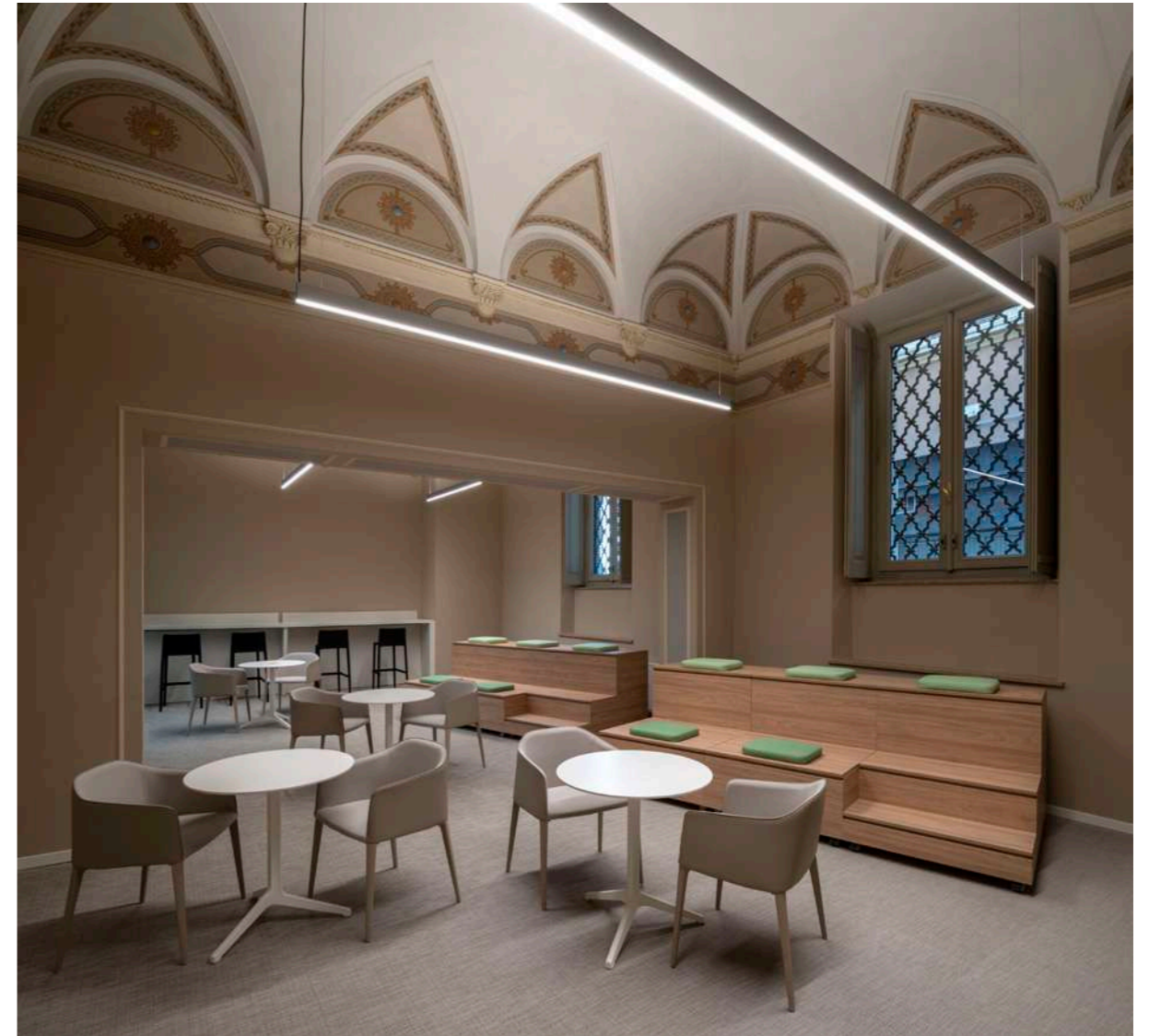

Le Village by CA

Parma, Italy

Project: Office

Architect: DEGW, L22 Civil
Engineering | Lombardini22

Products: Laja armchair,
Ypsilon table, Volt barstool



Pedrali collaborative space

Bergamo, Italy

Project: Headquarters
Architect: Park Associati
Products: Laja armchair, Arki-Table, Ypsilon Connect space divider

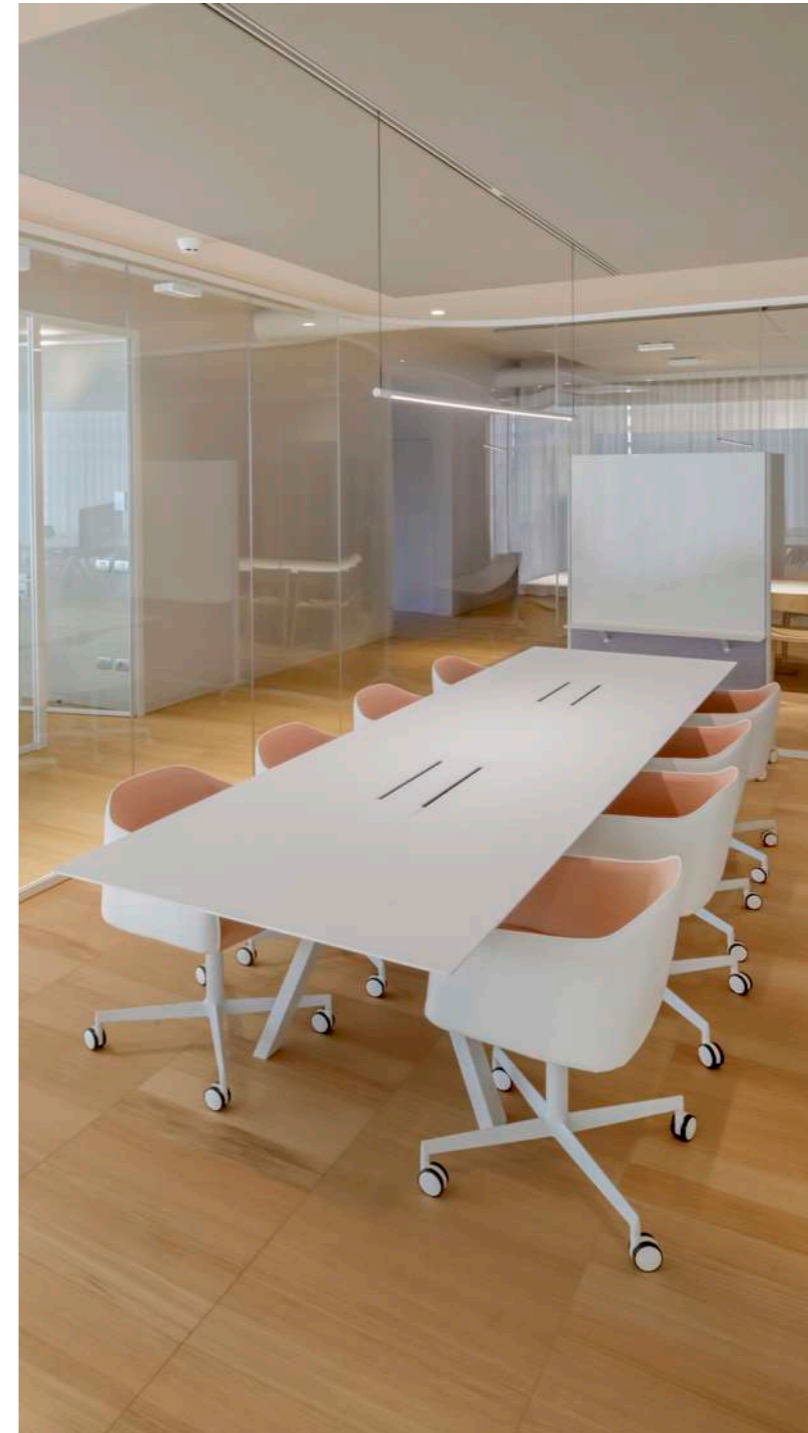

#Pedrali Workspaces

Orgatec 2022
 Cologne, Germany

Project: Exhibition stand
Products: Laja armchair, Ypsilon Connect space divider

SCOMAP offices emmapes building

Paris, France

Project: Office

Architect: DL2A Architects

Products: Laja armchair



deWol Industries hub

Milan, Italy

Project: Showroom

Architect: Isacco Brioschi Architects

Products: Laja armchair, Elinor table



Studio Nassini & Associati

Brescia, Italy

Project: Office

Products: Laja Wings armchair,
Plano table



880/2
Side chair, upholstered shell,
die-cast aluminium legs



883/2
Side chair, upholstered shell,
ash wood legs



885/2
Armchair, upholstered shell,
die-cast aluminium legs



881/2
Armchair, upholstered shell,
steel tubular frame



882/2
Armchair, upholstered shell,
steel tubular frame



884/2
Armchair, upholstered shell,
ash wood legs



886/2
Armchair, upholstered shell, die-cast
aluminium four-spoke base with castors



887/2 
Armchair, upholstered shell,
die-cast aluminium four-spoke base



888/2 
Armchair, upholstered shell, die-cast
aluminium five-spoke base with castors



889G
Upholstered armchair with castors



889F
Upholstered armchair



884T/2
Armchair, upholstered shell,
ash wood legs with tablet



885T/2
Armchair, upholstered shell,
die-cast aluminium legs with tablet



884/2TT
Optional tablet
TABLET: 300X265 - 11.8X10.4



FINISHES / FINITURE

coated ash / frassino verniciato

lacquered ash with visible grains / frassino laccato a poro aperto



FR
Bleached ash
Frassino sbiancato



N1
Light walnut
Noce chiaro

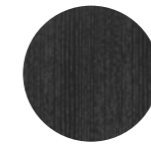

AN
Black
Nero

fabrics / tessuti

→ see booklet for finishes
vedi catalogo finiture

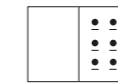

aluminium / alluminio

steel / acciaio

powder coated / verniciato



LU
Polished
Lucidato



CR
Chromed
Cromato

→ see booklet for finishes
vedi catalogo finiture

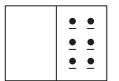

CERTIFICATES / CERTIFICAZIONI

Safety, strength and durability tests / Prove di sicurezza, resistenza e durata
EN 1728:2012+AC2013 — EN 16139:2013 level 2 — EN 1728:2000



Temps

Time is precious

DESIGN
Jorge Pensi Design Studio, 2018

EN — Temps is a task chair with an essential and yet elegant design, able to fit in the most varied office life needs. An injection-moulded polypropylene shell supports the seat in the lumbar side, conferring continuity between the comfort and ergonomics of the upholstery, equally the functionality and dynamism of the plastic material. Available also with low backrest.

IT — Temps è una seduta operativa dal design essenziale ed elegante al tempo stesso, capace di vivere all'interno di contesti operativi differenti. Un guscio in polipropilene stampato a iniezione cinge il sedile nella zona lombare stabilendo una continuità tra il comfort e l'ergonomia dell'imbottito e la funzionalità e il dinamismo del materiale plastico. Disponibile anche con schienale basso.



WORKSPACE

Task chair sedia operativa Temps low back
Table tavolo Arki-Table adj desk
Storage system Sistema contenitore Boxie
Lighting lampada Giravolta



Task chair sedia operativa Temps high back



Task chair high back

Sedia operativa schienale alto

**Weight-activated
synchro-tilt mechanism**
Meccanismo sincronizzato
di inclinazione dello
schienale, autopesante

**Backrest tilt
adjustment**
Regolazione
inclinazione
schienale

3765



Low back task chair

Sedia operativa con schienale basso





Seat-height
adjustment
Regolazione
altezza seduta

Injected polypropylene
armrests, glass fiber
charged
Braccioli in polipropilene,
caricato fibra di vetro



ARKW9_318X140 + DSP/2

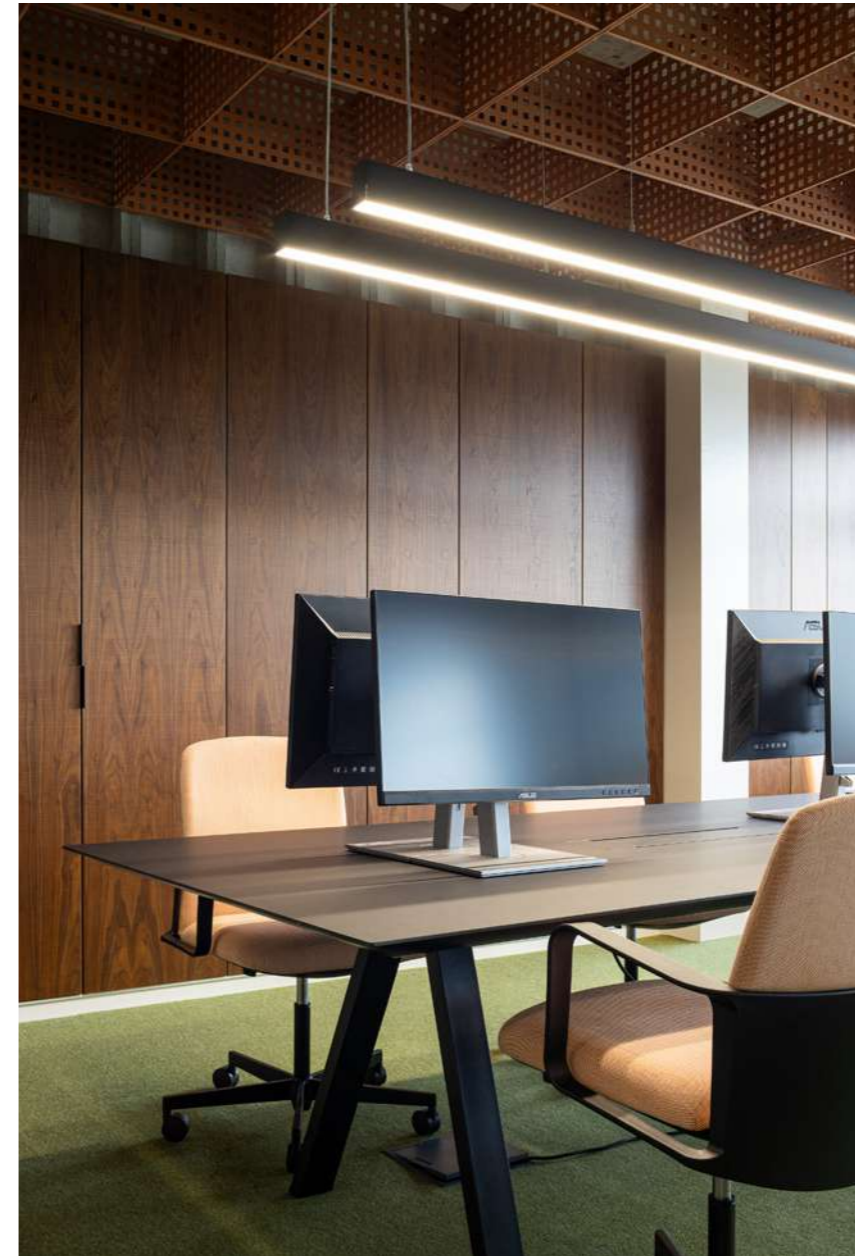

BRAZY Lisboa

Lisboa, Portugal

Project: Office

Architect: Zutto Design e arquitectura

Products: Temps low back task chair, Kuadro desk with divider sound absorbing panel, Boxie storage system, Arki-Table

Planet Group Knokke

Knokke-Heist, Belgium

Project: Office

Architect: Buro Project X Anthony Boelaert

Products: Temps high back task chair



#PedraliPalaceofWonders

Salone del Mobile.Milano 2019

Milan, Italy

Project: Exhibition stand

Architect: CalviBrambilla

Products: Boxie storage system, Flag coat stand, Arki-Table Adjustable, Temps high back task chair, Snooze sound absorbing panel

#pedralitales

Antwerp, Belgium

Project: 2021 ADV campaign

Products: Temps low back task chair,
Arki-Desk table



SIZES / DIMENSIONI

mm - in

3765

Upholstered task chair, die-cast aluminium
five-spoke base with castors, adjustable in height



3766

Upholstered task chair, die-cast aluminium
five-spoke base with castors, adjustable in height



FINISHES / FINITURE

aluminium / alluminio

powder coated / verniciato

polypropylene / polipropilene



LU*
Polished
Lucidato

* Finitura bracciolo solo nero
Armrest finish black only



BI200

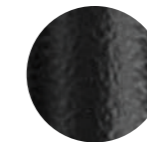

NERO



NE

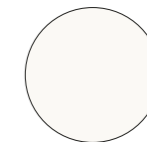

BI

fabrics / tessuti

→ see booklet for finishes
vedi catalogo finiture

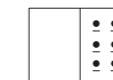

AWARDS / PREMI



CERTIFICATES / CERTIFICAZIONI

Safety, strength and durability tests / Prove di sicurezza, resistenza e durata
EN 1728:2012+AC2013 — EN 1335-2:2018 — ANSI-BIFMA X5.1-2017

Rizz

Streamlined fluidity

DESIGN
Robin Rizzini, 2023

EN— Rizz is a table with an aluminium frame that ensures strength and lightness at the same time. The diecast aluminium legs are featured by a triangular section that faces outwards and tapers into a round shape, resting elegantly on the floor. A structural strength concealed by clean lines distinguishes this table, which integrates the legs with an aluminium supporting frame hidden beneath the tabletop. The workstation version is a system of two-, four- or eight-seater workstations. For longer meeting or working tables, a central rectangular steel column with rounded edges ensures stability while serving as cable management.

IT— Rizz è un tavolo in alluminio che garantisce resistenza e leggerezza al tempo stesso. Le gambe affusolate in pressofusione di alluminio sono caratterizzate da una sezione triangolare aperta verso l'esterno e si assottigliano in una sezione tonda appoggiandosi elegantemente a terra. Una solidità strutturale celata da una pulizia di forme caratterizza questo tavolo, che integra le gambe ad una struttura portante nascosta sotto il ripiano. La versione workstation è un sistema a due, quattro o otto postazioni. Per sostenere ripiani di grandi dimensioni, nella parte centrale al di sotto del ripiano, è presente una colonna rettangolare con angoli stondati in acciaio che funge anche da passacavi.



reception



WORKSPACE

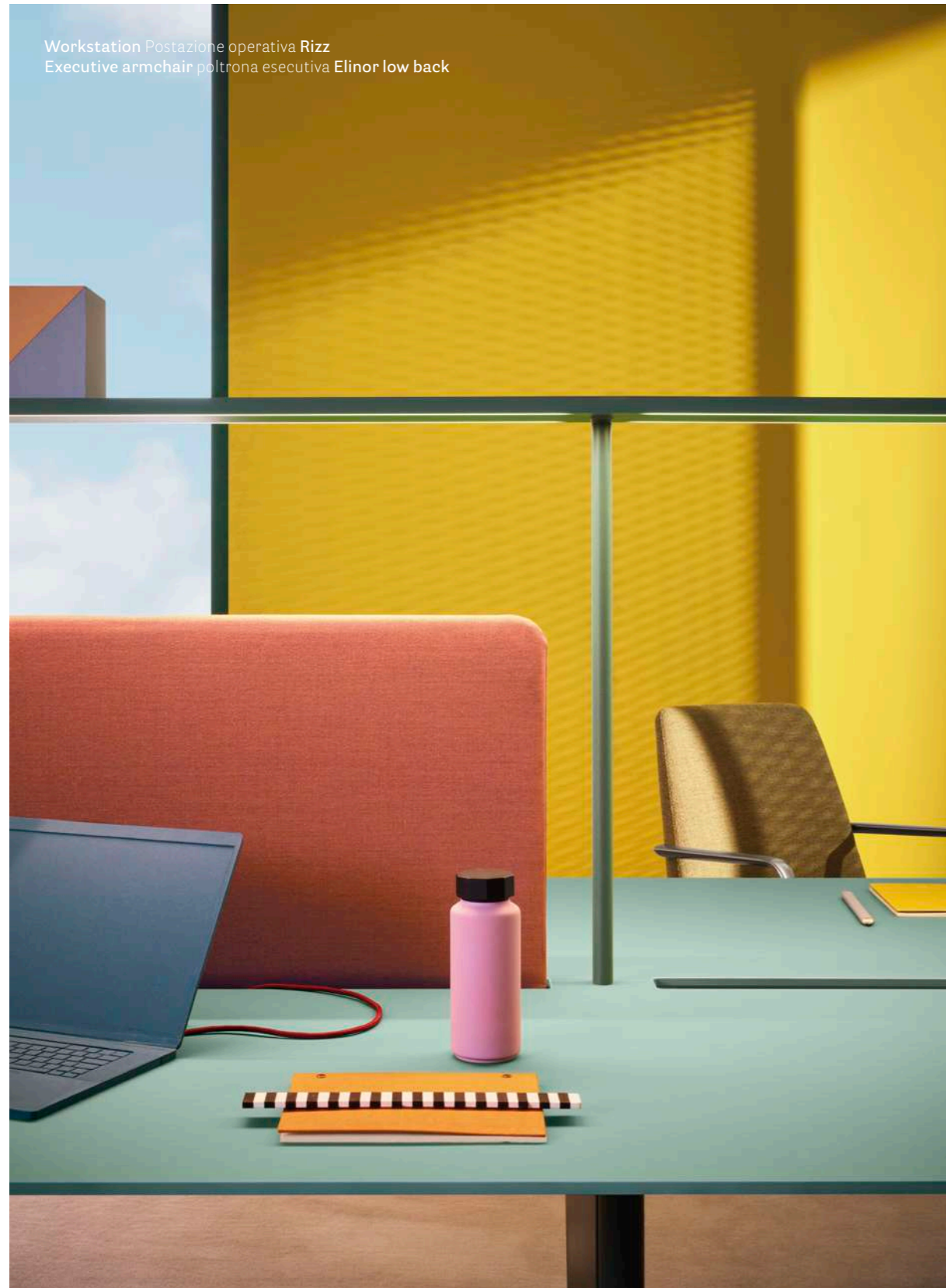

LIVING

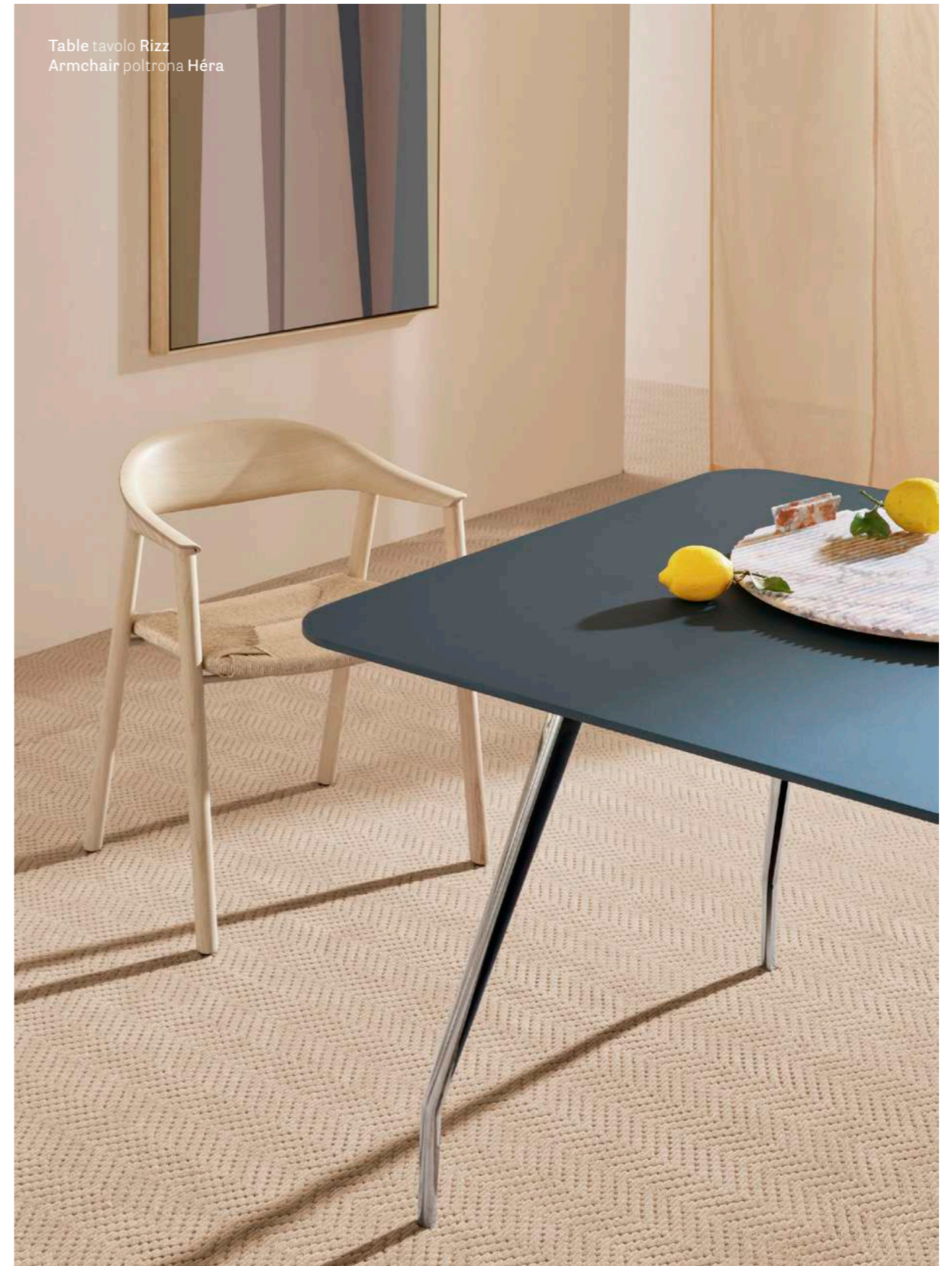

Table tavolo Rizz
Armchair poltrona Héra
Lighting lampada Tamara



Workstation

Postazione operativa



Two-, four- or eight-seater workstation
Due, quattro o otto postazioni

Dimmable LED lighting system with central bridge structure. Sound-absorbing screen
Sistema di illuminazione LED con struttura centrale a ponte, dimmerabile. Pannello fonoassorbente



TRZ2_340X150CC + K_LUCE_LB264 + DSP_L120

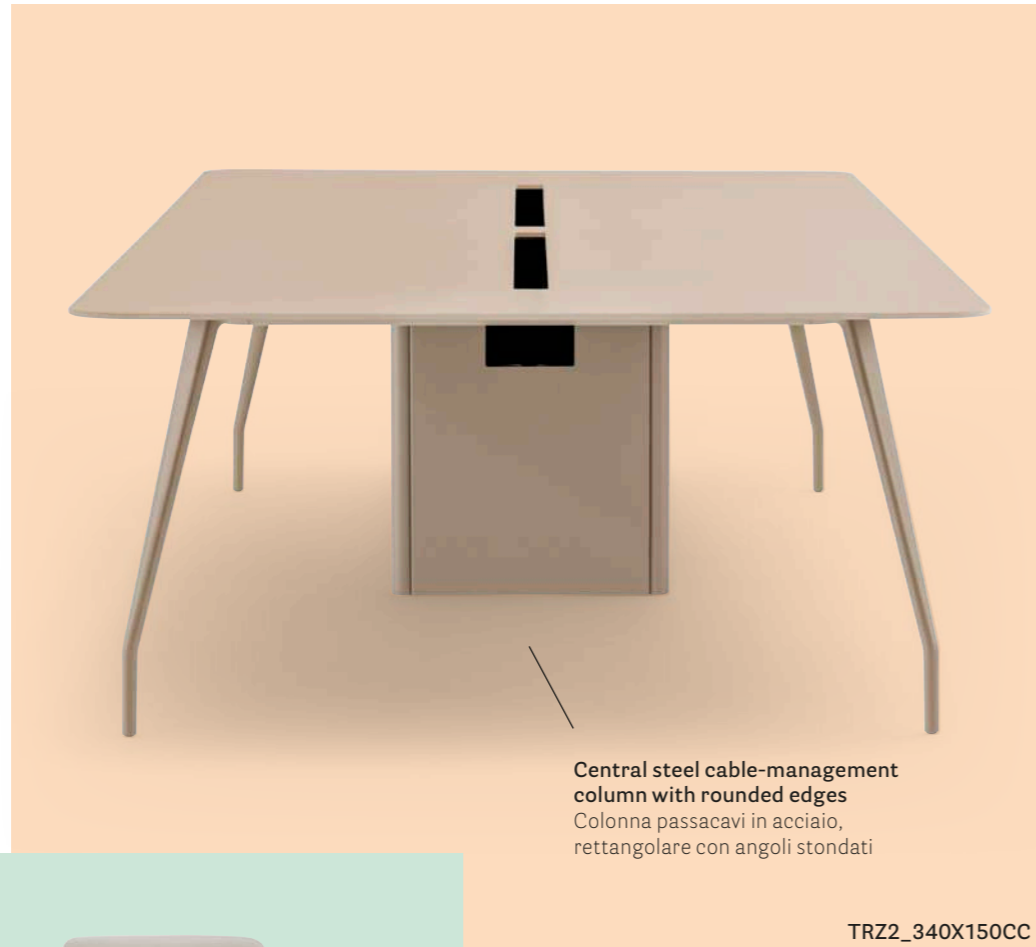

Central steel cable-management column with rounded edges
Colonna passacavi in acciaio, rettangolare con angoli stondati

TRZ2_340X150CC



3755

Table Tavolo



Walnut wood effect solid laminate top, polished die-cast aluminium legs
Ripiano in stratificato color noce, gambe in pressofusione di alluminio lucidato

TRZ265X100



TRZ265X10CCO

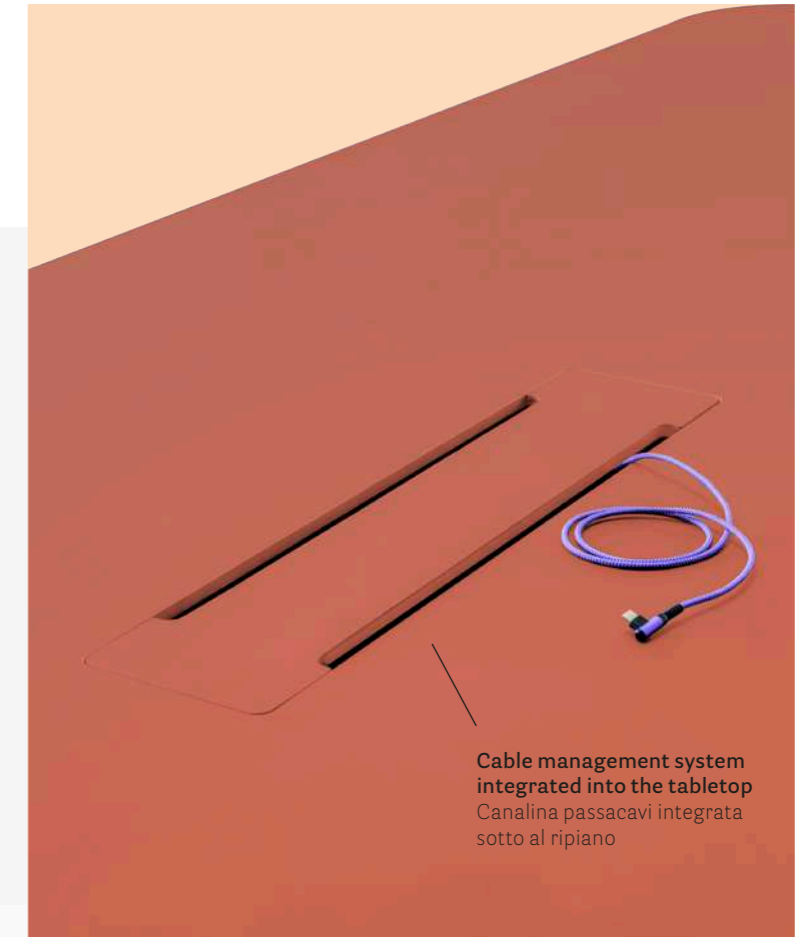

Cable management system
integrated into the tabletop
Canalina passacavi integrata
sotto al ripiano

Toa

Strength and lightness

DESIGN
Robin Rizzini, 2020

EN — The Toa table combines a technical-industrial style with decorative allure, giving life to a functional and evocative product. Lightweight and minimalist, the Toa table is characterised by a solid die-cast aluminium frame in a fluid geometric design connected by two steel beams suitable to support large sizes tops. Toa's main features are its tapered bridge legs made of die-cast aluminium, which are thinner at the base and widen up towards the "T" element that supports the top.

IT — Toa è un tavolo che unisce con equilibrio il linguaggio tecnico-industriale a quello decorativo, dando vita ad un prodotto funzionale ed espressivo. Leggero ed essenziale alla vista, il tavolo Toa è caratterizzato da una robusta struttura in pressofusione di alluminio dalla forma geometrica e fluida supportata da due barre in acciaio capaci di sostenere anche ripiani di grandi dimensioni. Elemento caratterizzante di Toa sono le gambe a ponte dalla forma affusolata realizzate in pressofusione di alluminio che, più sottili alla base, si allargano verso l'alto confluendo sotto al ripiano in un elemento a "T".



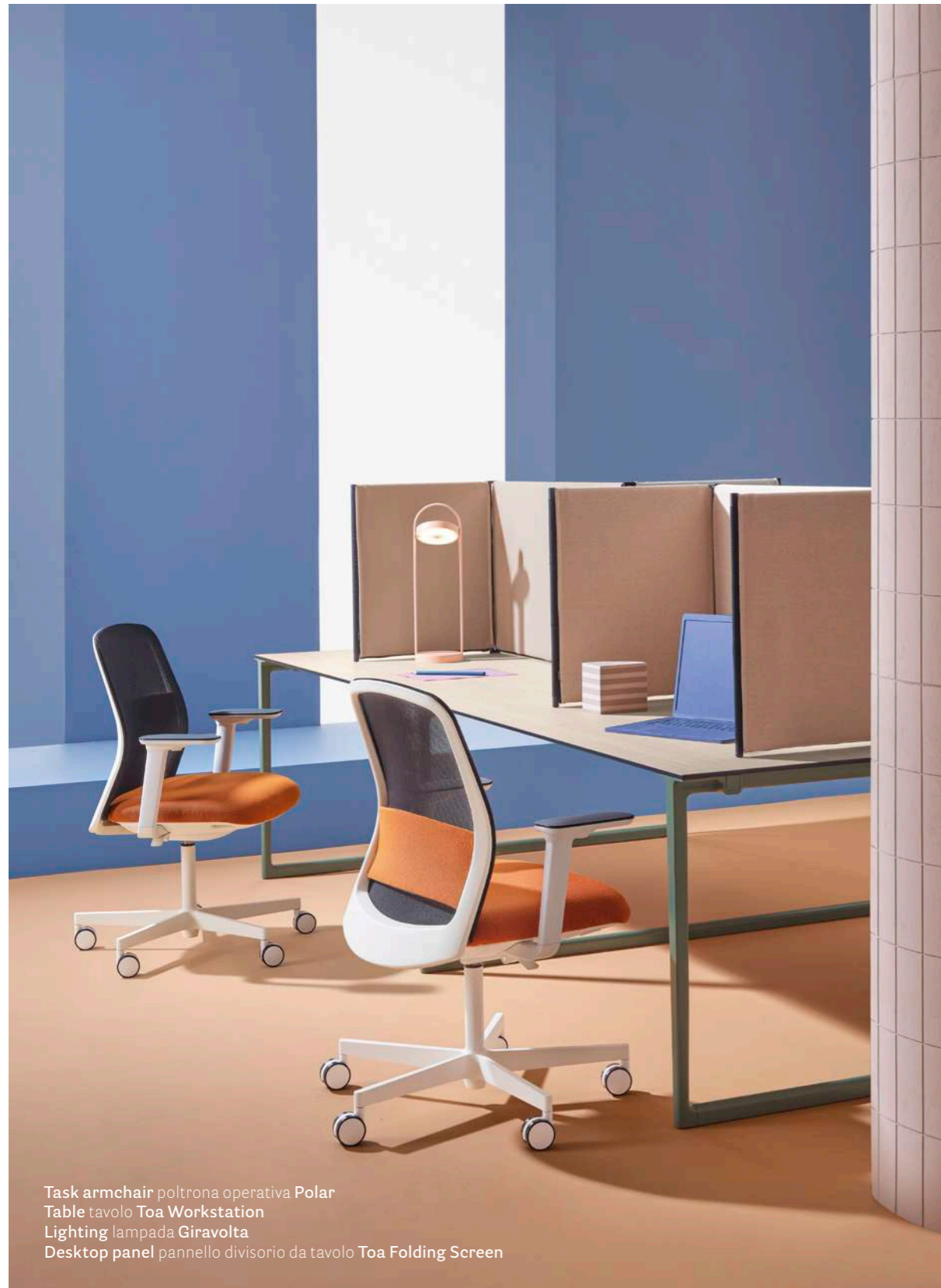

Task armchair poltrona operativa Polar
 Table tavolo Toa Workstation
 Lighting lampada Giravolta
 Desktop panel pannello divisorio da tavolo Toa Folding Screen



Task chair sedia operativa Elinor high back
 Table tavolo Toa

Table tavolo Toa

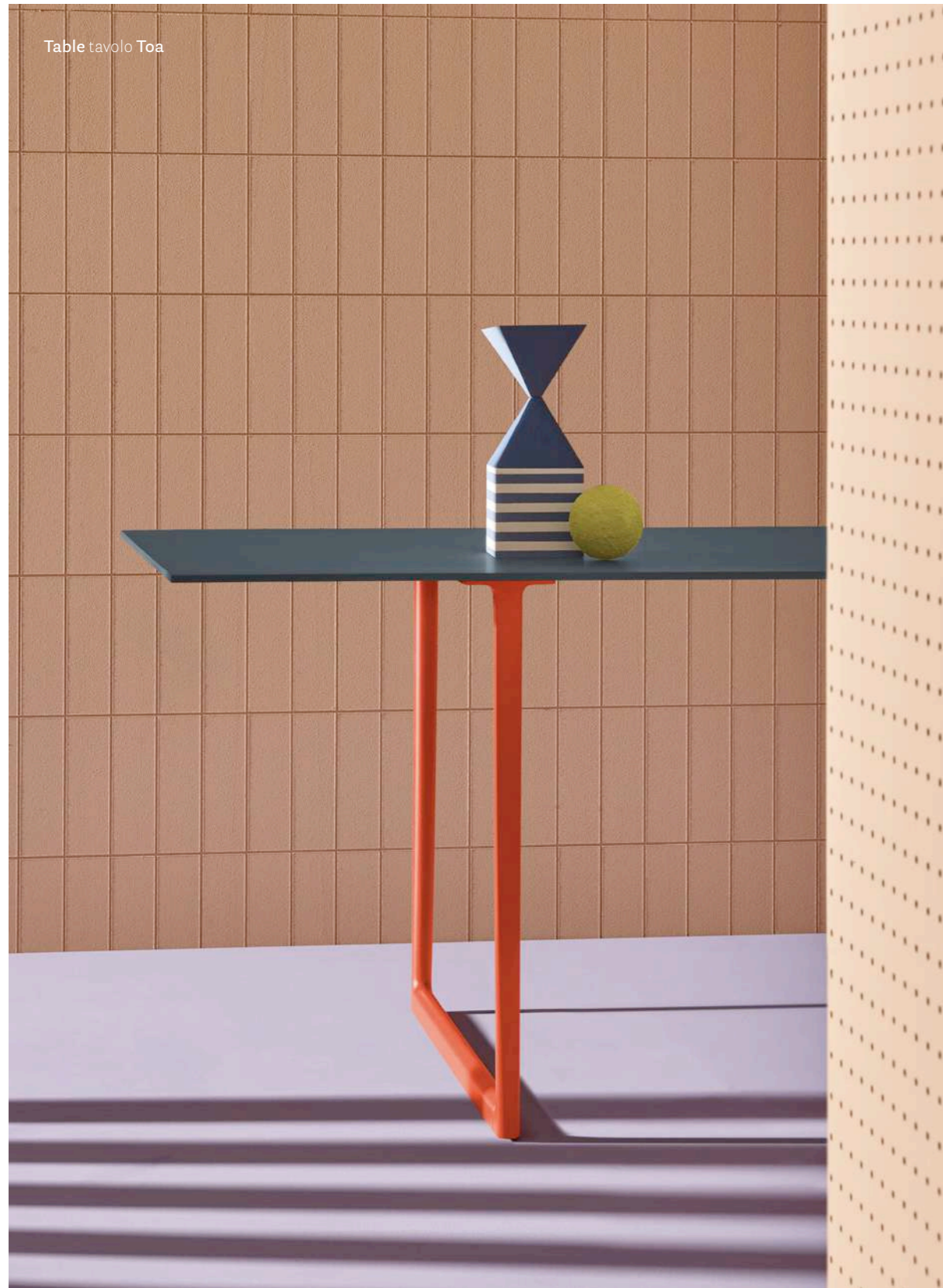

Table Tavolo



TOA240X90



Workstation

Postazione operativa

Four workstations table with die-cast aluminium legs placed at the ends of the top
Tavolo a quattro postazioni con gambe in alluminio poste alle estremità del ripiano

Sound absorbing panel
Pannello fonoassorbente
h 445 mm - 17.5 in



TOA3S_300X150 + DSP



2877

Cable management system designed to accommodate sound-absorbing screens
 Canalina predisposta per accogliere pannelli fonoassorbenti



TOA3S_159X150

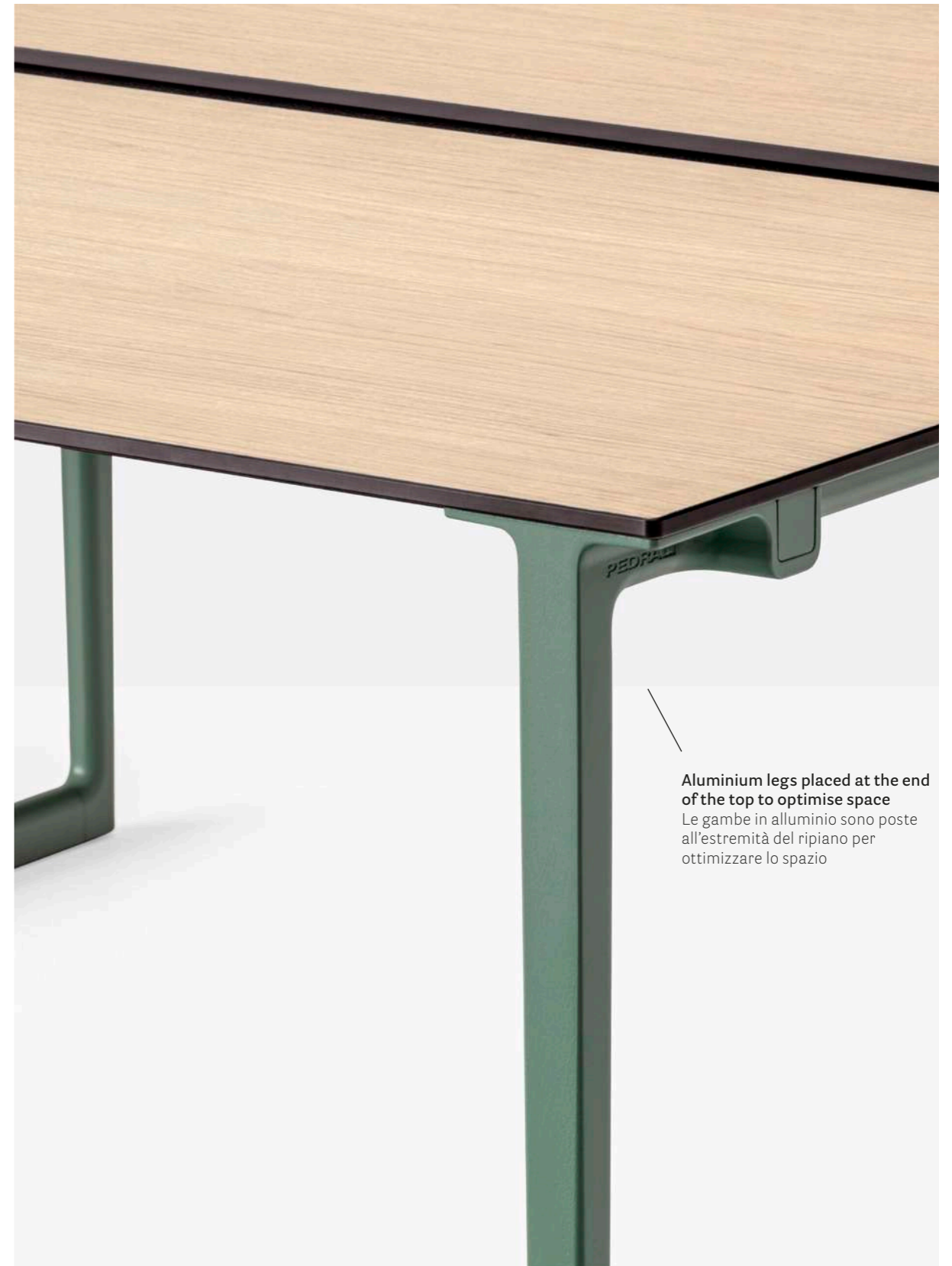

Aluminium legs placed at the end of the top to optimise space
 Le gambe in alluminio sono poste all'estremità del ripiano per ottimizzare lo spazio



Mossos D'esquadra Training Center

Barcelona, Spain

Project: Office

Architect: Albert Martinez Esteve, Ricard Turon Vich

Products: Toa table, Temps low back task chair

Pedrali collaborative space

Bergamo, Italy

Project: Headquarters

Architect: Park Associati

Products: Toa table, Nemea side chair,
Buddyhub box and sofa, Arki-Table adj desk,
Polar task armchair

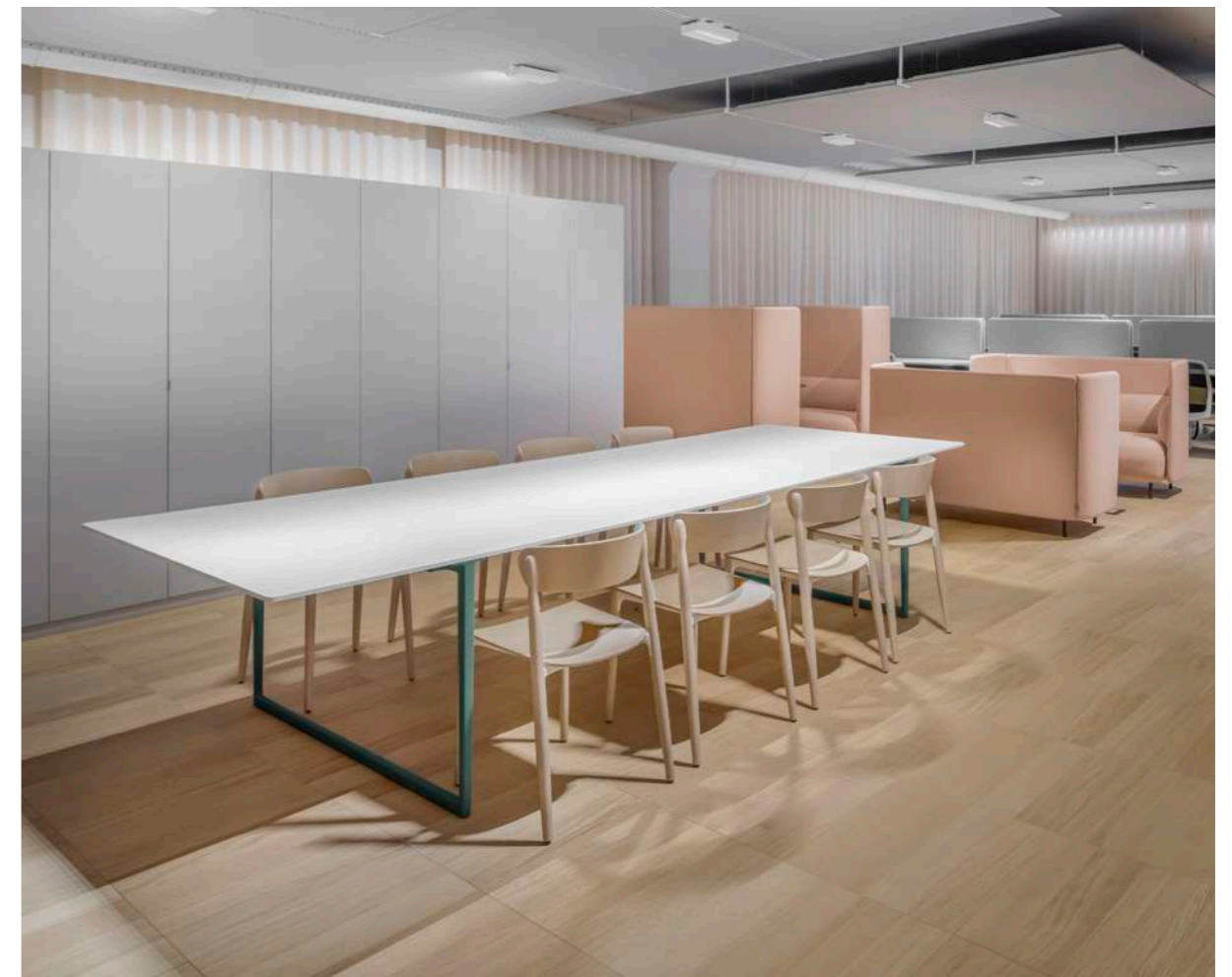

Living Corriere

Project: shooting
Products: Toa table,
 Lamorisse armchair

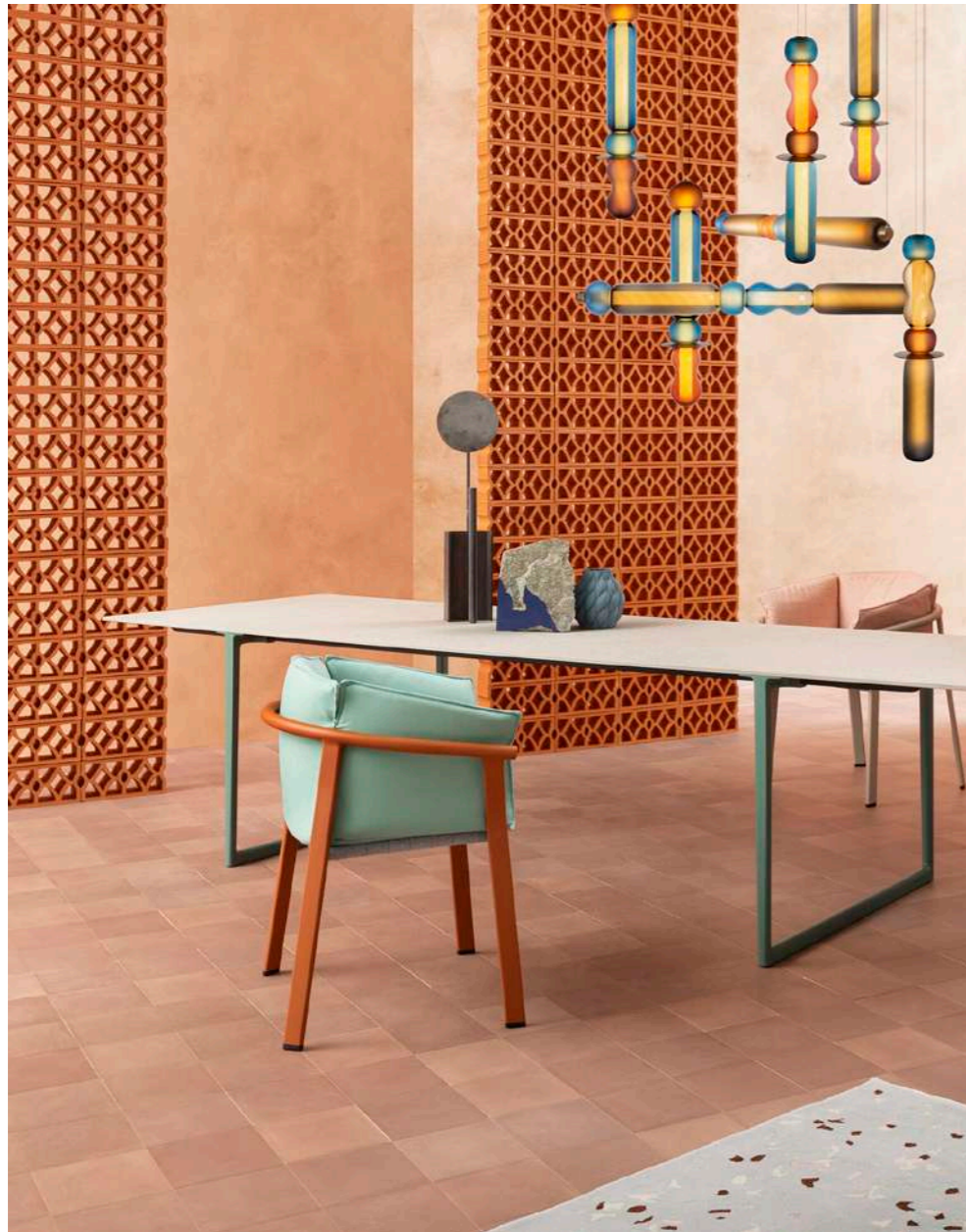

TOA240X90

Table desk, die-cast aluminium legs,
 solid laminate or veneered top

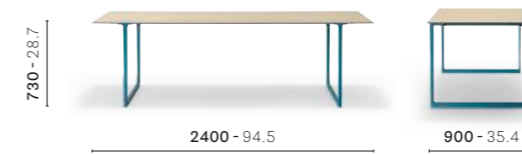

TOA240X90_CD

Table desk, die-cast aluminium legs,
 solid laminate, cable management (300x82 - 11.8x3.2)

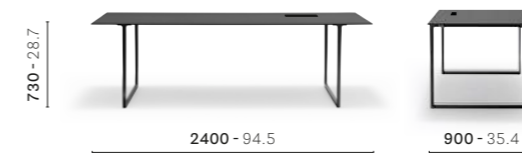

TOA240X90_CSX

Table desk, die-cast aluminium legs,
 solid laminate, cable management (300x82 - 11.8x3.2)

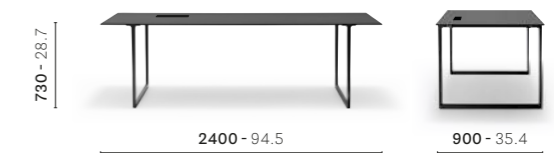

TOA190X75

Table, die-cast aluminium legs,
 solid laminate top

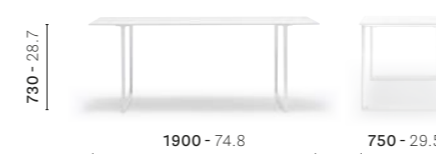

TOA190X90

Table, die-cast aluminium legs,
 solid laminate top



TOA300X100/125

Table, die-cast aluminium legs,
 solid laminate top



TOA360X100/125

Table, die-cast aluminium legs,
 solid laminate top



TOA300X100/125 CC60

Table, die-cast aluminium legs, solid laminate top, cable management (1000x60 - 39.4x2.4)



TOA300X100/125 CCO

Table, die-cast aluminium legs, solid laminate top, cable management (600x132 - 23.6x5.2)



TOA300X100/125 SPEC

Table, die-cast aluminium legs, solid laminate top, cable management (418x112 - 16.5x4.4)



TOA360X100/125 CC60

Table, die-cast aluminium legs, solid laminate top, cable management (1000x60 - 39.4x2.4)



TOA360X100/125 CCO

Table, die-cast aluminium legs, solid laminate top, cable management (600x132 - 23.6x5.2)



TOA360X100/125 SPEC

Table, die-cast aluminium legs, solid laminate top, cable management (418x112 - 16.5x4.4)



TOA2_519X125

Conference table, die-cast aluminium legs, solid laminate top

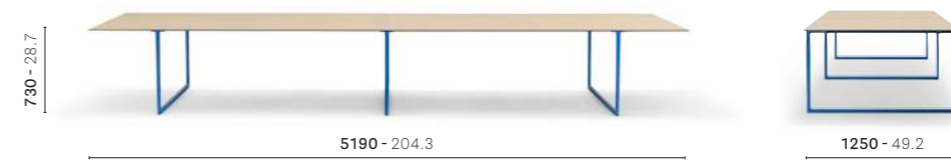

TOA2_610X130

Conference table, die-cast aluminium legs, solid laminate top

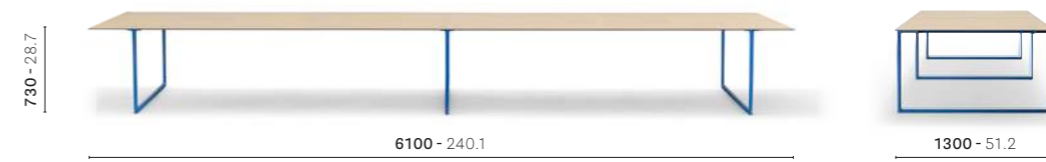

TOA2_519X125 CC60

Conference table, die-cast aluminium legs, solid laminate top, cable management (1000x60 - 39.4x2.4)



TOA2_519X125 CCO

Conference table, die-cast aluminium legs, solid laminate top, cable management (600x132 - 23.6x5.2)



TOA2_519X125 SPEC

Conference table, die-cast aluminium legs, solid laminate top, cable management (418x112 - 16.5x4.4)



TOA2_610X130 CC60

Conference table, die-cast aluminium legs, solid laminate top, cable management (1000x60 - 39.4x2.4)

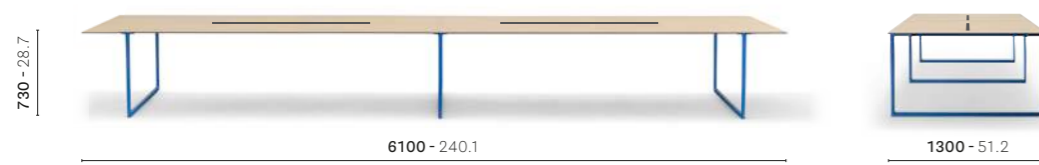

TOA2_610X130 CCO

Conference table, die-cast aluminium legs, solid laminate top, cable management (600x132 - 23.6x5.2)

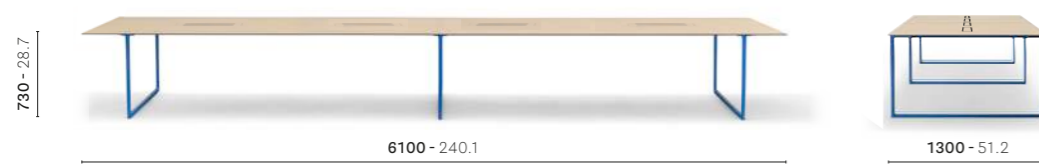

TOA2_610X130 SPEC

Conference table, die-cast aluminium legs, solid laminate top, cable management (418x112 - 16.5x4.4)

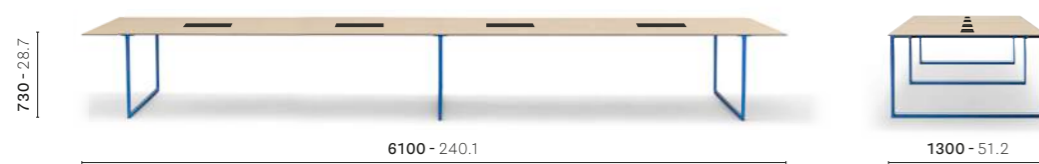

TOA3S_159X150

Workstation table, die-cast aluminium legs, solid laminate top, cable management (1300x60 - 51.2x2.4)



TOA3S_300X150

Conference table, die-cast aluminium legs, solid laminate top, cable management (1300x60 - 51.2x2.4)



DSP/L130

Sound absorbing divider panel (1300x455 - 51.2x17.9)



DSP/2_L130

Sound absorbing divider panel (1300x615 - 51.2x24.2)



FINISHES / FINITURE

solid laminate top / ripiano in stratificato

*Anti-fingerprint
Anti-impronta

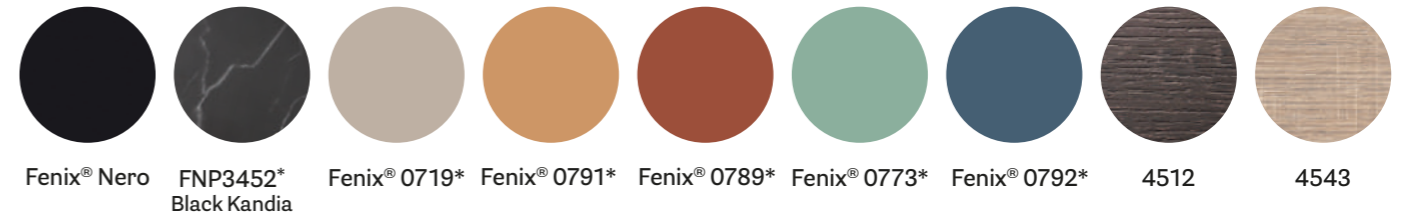

solid laminate top / ripiano in stratificato



oak veneered top /

ripiano in rovere impiallacciato

aluminium frame / telaio in alluminio

powder coated / verniciato

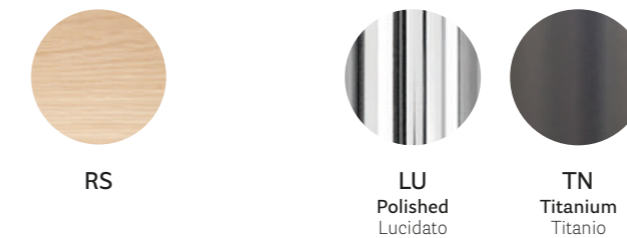

→ see booklet for finishes
vedi catalogo finiture

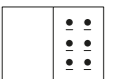

Toa Folding Screen

A table divider

DESIGN
Robin Rizzini, 2020

EN – The Toa Folding Screen is a sound absorbing desktop panel that separates and defines spaces. Designed to meet the mobility and layout requirements of modern work spaces. The inner metal structure is upholstered in fabric with a zip that makes it easy to remove, clean and maintain. It's also the perfect solution for home working spacial arrangements. Given that it is extremely lightweight, the screen can be folded with ease and moved from one place to another.

IT – Toa Folding Screen è un pannello divisorio fonoassorbente da tavolo in grado di definire e separare lo spazio. È pensato per rispondere alle esigenze di mobilità e configurabilità dei moderni working spaces. Una struttura di metallo rivestita in tessuto che, grazie alla presenza di una zip posta nella parte inferiore dello screen, è sfoderabile, facile da pulire e mantenere. In caso di smart working risulta inoltre uno strumento ottimale per ritagliarsi uno spazio all'interno del proprio contesto domestico. È pieghevole e leggero e può essere facilmente spostato da un luogo all'altro.



WORKSPACE



DESKTOP PANEL / PANNELLO DIVISORIO DA TAVOLO

Variety of layouts to create multiple workstations
Layout diversi per creare postazioni multiple



Black steel tube frame
Struttura in tubo d'acciaio nero
Ø 16 mm - Ø 0.63 in

Upholstered in fabric with zip
Rivestito in tessuto con zip

TFS



TFS

Desktop panel, metal structure

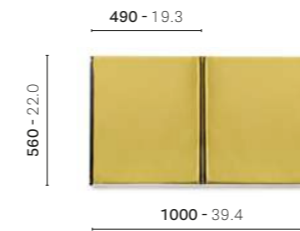

EXAMPLES OF COMBINATIONS / ESEMPI DI CONFIGURAZIONI

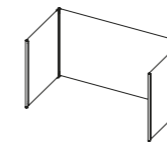

U

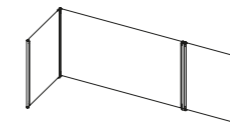

L

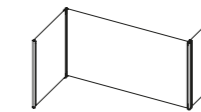

S

FINISHES / FINITURE

steel / acciaio

fabrics / tessuti

→ see booklet for finishes
vedi catalogo finiture



NEF

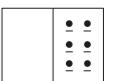

#PedraliWorkspaces

Orgatec 2022
Cologne, Germany

Project: Exhibition stand

Products: Toa Folding Screen desktop panel, Toa table workstation, Babila XL armchair, Isotta lighting, Snooze sound absorbing panel

Hevea

Nature inside

DESIGN
Victoria Azadinho Bocconi, 2022

EN — Hevea is a versatile furnishing element that brings nature into residential and contract settings. This pot-holder consists of a central steel stem to which polypropylene pots are hanged, obtaining different configurations based on their number and position.

IT — Hevea è un complemento d'arredo versatile che permette di portare la natura all'interno di ambienti domestici e contract. Un portavasi composto da uno stelo centrale in acciaio al quale vengono agganciati vasi in polipropilene ottenendo così diverse configurazioni in base al loro numero e alla loro posizione.



WAITING

Pot-holder portavasi Hevea
Lounge armchair poltrona lounge Osaka

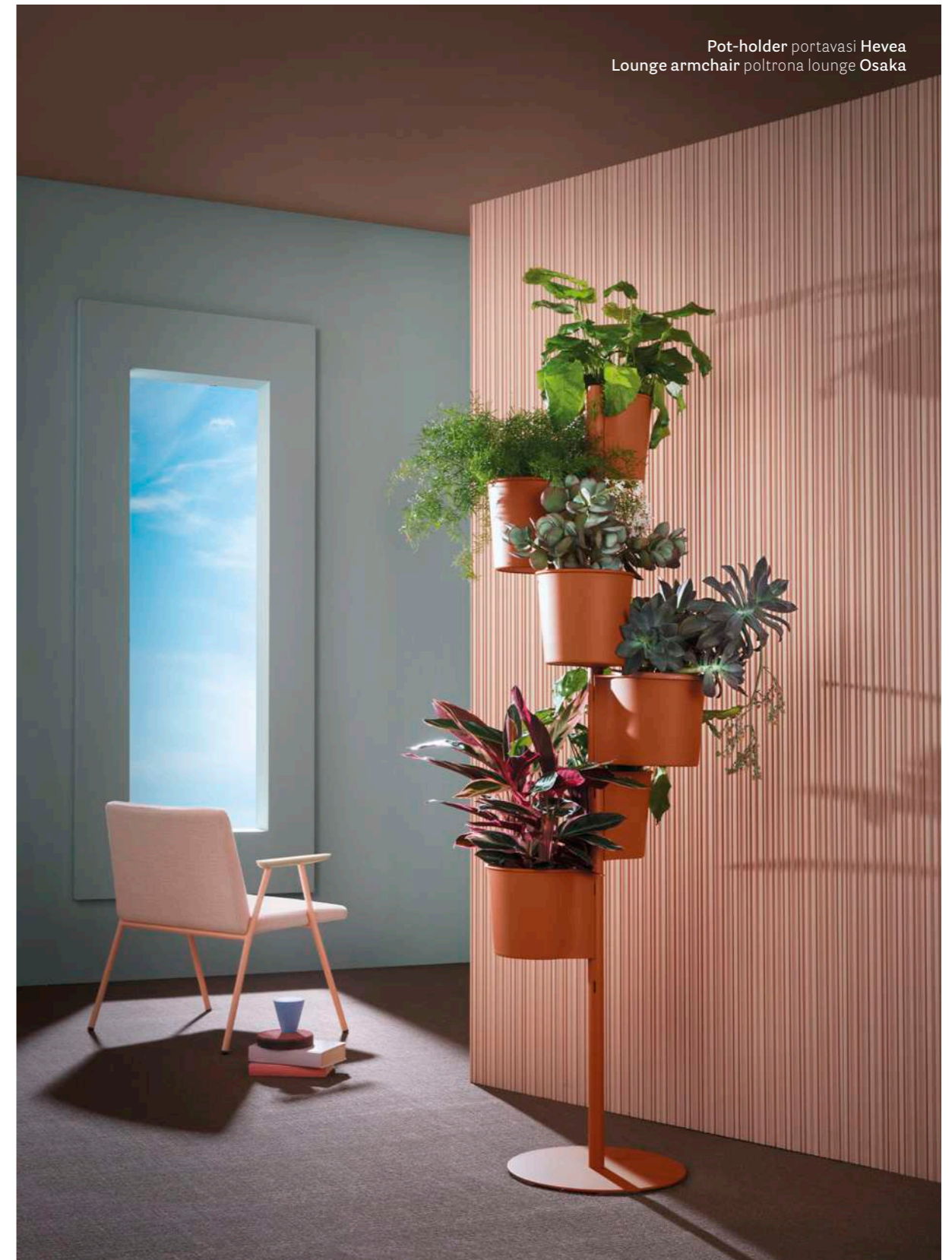



Pot-holder portavasi Hevea
Poseur table tavolo alto Elliot
Barstool sgabello Babila

Pot-holder Portavasi



Hevea Partition



Polypropylene
pot-holders
Portavasi
in polipropilene



The pots are easy to attach,
either opposite one another or in
a spiral, giving life to unique and
potentially infinite compositions
È possibile fissare i vasi
posizionandoli contrapposti tra loro
o a spirale e dare vita a composizioni
uniche e potenzialmente infinite

5181

#PedraliWorkspaces

Orgatec 2022
Cologne, Germany

Project: Exhibition stand

Products: Hevea pot-holder, Ester armchair,
Elliot table



Temporary installation

Bergamo, Italy

Project: Shooting

Products: Hevea pot-holder, Elliot
poseur table

Pedrali - new company canteen

Bergamo, Italy

Project: Company Canteen

Architect: Park Associati

Products: Hevea pot-holder, Arki-Table, Dome side chair, Folk chair, TO.BE lighting, Volt side chair, Fabbrico table



SIZES / DIMENSIONI

mm - in

5181

Pot-holder, steel structure, polypropylene pot-holders



5183

Hevea Partition pot-holder, steel structure, polypropylene pot-holders



K_5180_1

Pot-holder/pot and hook kit



K_5180_3

Pot-holders and hooks kit



5182

Hevea ice bucket steel structure, polypropylene pot-holder



FINISHES / FINITURE

polypropylene in the same colour of the frame / polipropilene in tinta con il telaio



powder coated / verniciato



AWARDS / PREMI



BIG SEE
Product Design
Award 2023
Winner

Arki-Table

A perfect balance

DESIGN
Pedrali R&D, 2012

EN — Arki-Table is a linear and rigorous table from a structural point of view, but at the same time versatile and designed for different uses. It is characterized by an ultra-thin top supported by an extruded aluminium frame, which remains hidden. The trestle legs in steel or solid oak ensure stability and grip on the ground.

IT — Il tavolo Arki-Table è lineare e rigoroso dal punto di vista strutturale, ma al contempo versatile e pensato per situazioni d'uso differenti. È caratterizzato da un ripiano ultra-sottile sostenuto da una cornice in estruso di alluminio, che rimane nascosta. Le gambe a cavalletto realizzate in acciaio o in massello di rovere garantiscono stabilità e aderenza al suolo.



WORKSPACE



Table tavolo Arki-Table Wood
Modular seating seduta modulare Arki-Bench

MEETING



Table tavolo Arki-Table Wood
Side chair sedia Tweet
Armchair poltrona Tweet



Table tavolo Arki-Table
 Armchair poltrona Laja
 Lighting lampada L002
 Pot vaso Kado 2
 Umbrella stand portaombrelli Brik
 Coat hanger appendiabiti Flag

Table
Tavolo



**Ultra-thin solid laminate top supported
by a frame made of extruded aluminium**
Ripiano ultrasottile in stratificato supportato
da un profilo in estruso di alluminio

ARK360X120CC60



Table tavolo Arki-Table desk
 Task chair sedia operativa Polar
 Lighting lampada Giravolta
 Storage system sistema contenitore Boxie



Workstation

Postazione operativa



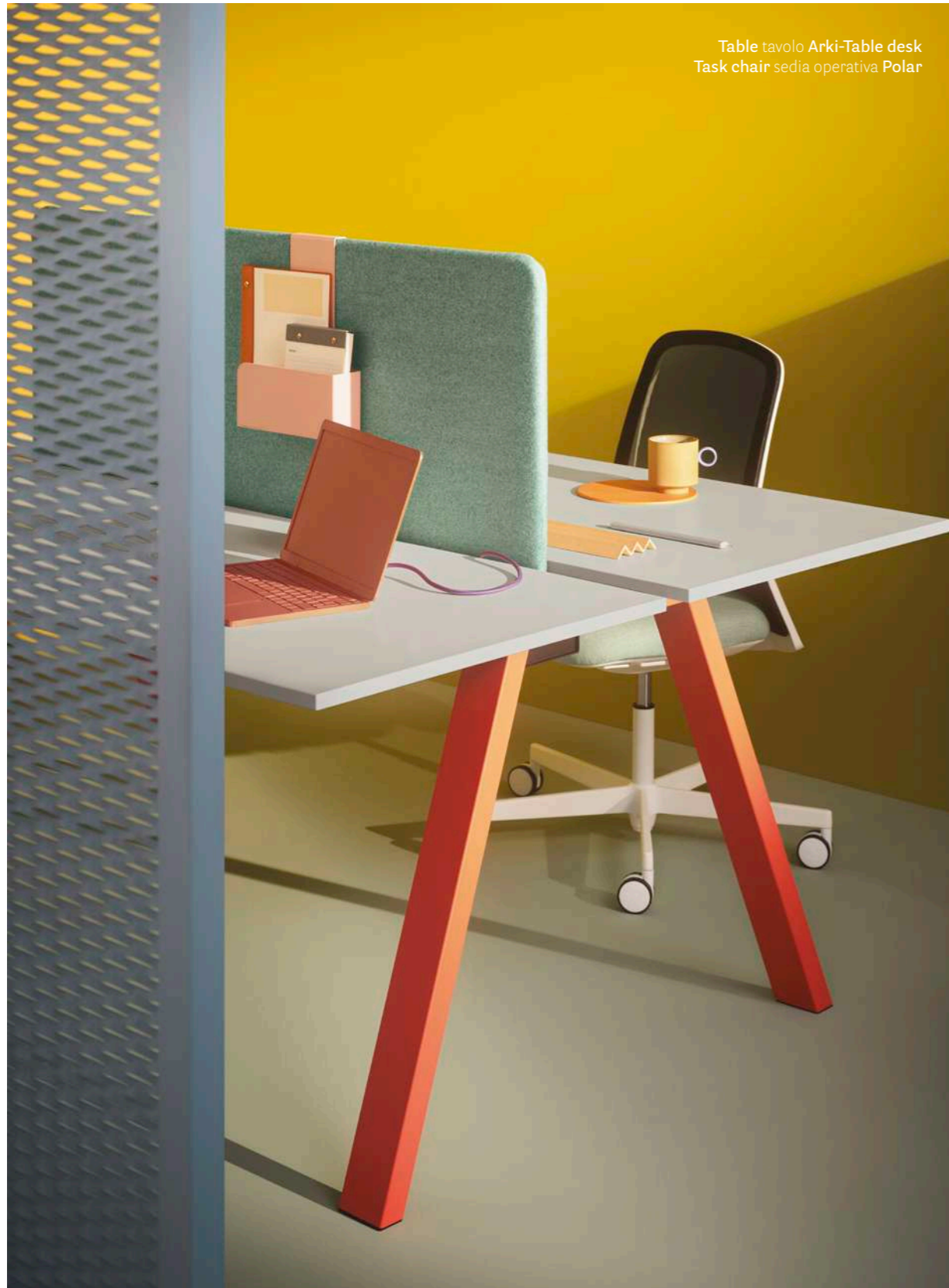

Table tavolo Arki-Table adj desk
 Task chair sedia operativa Temps high back
 Storage system sistema contenitore Boxie
 Lighting lampada Giravolta

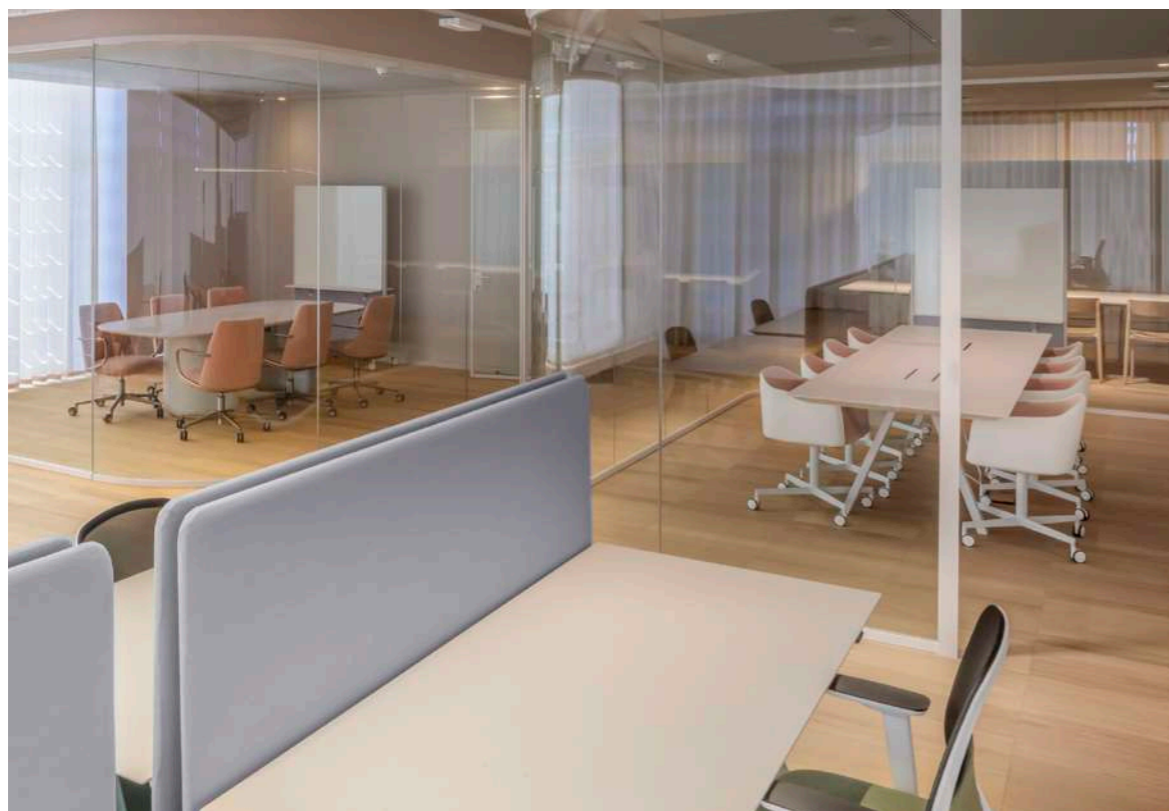

Table adjustable

Tavolo regolabile







Treuhand Union Steuerberatung GMBH

Salzburg, Austria

Project: Office

Architect: Mutant Arch.Media

Products: Arki-Table, Babila side chair



Pedrali collaborative space

Mornico al Serio, Italy

Project: Headquarters

Architects: Park Associati

Products: Polar task chair,
Arki-table adj desk, Laja
armchair, Elinor low back
executive chair and table,
Arki-table, Ypsilon Connect
space divider, Nemea side
chair, Toa table, Buddyhub
armchair



Vemado office

Belgium

Project: Office
Architect: Buro Belgium
Products: Arki-Table,
Osaka Metal armchair

Novo Nordisk

Quinta da Fonte, Portugal

Project: Office
Architect: Vector Mais
Products: Arki-Table adjustable,
Babila barstool



Kilometro Rosso

Bergamo, Italy

Project: Company Canteen

Architect: Luca Bombassei Studio

Products: Arki-Table,
Babila armchair and barstool

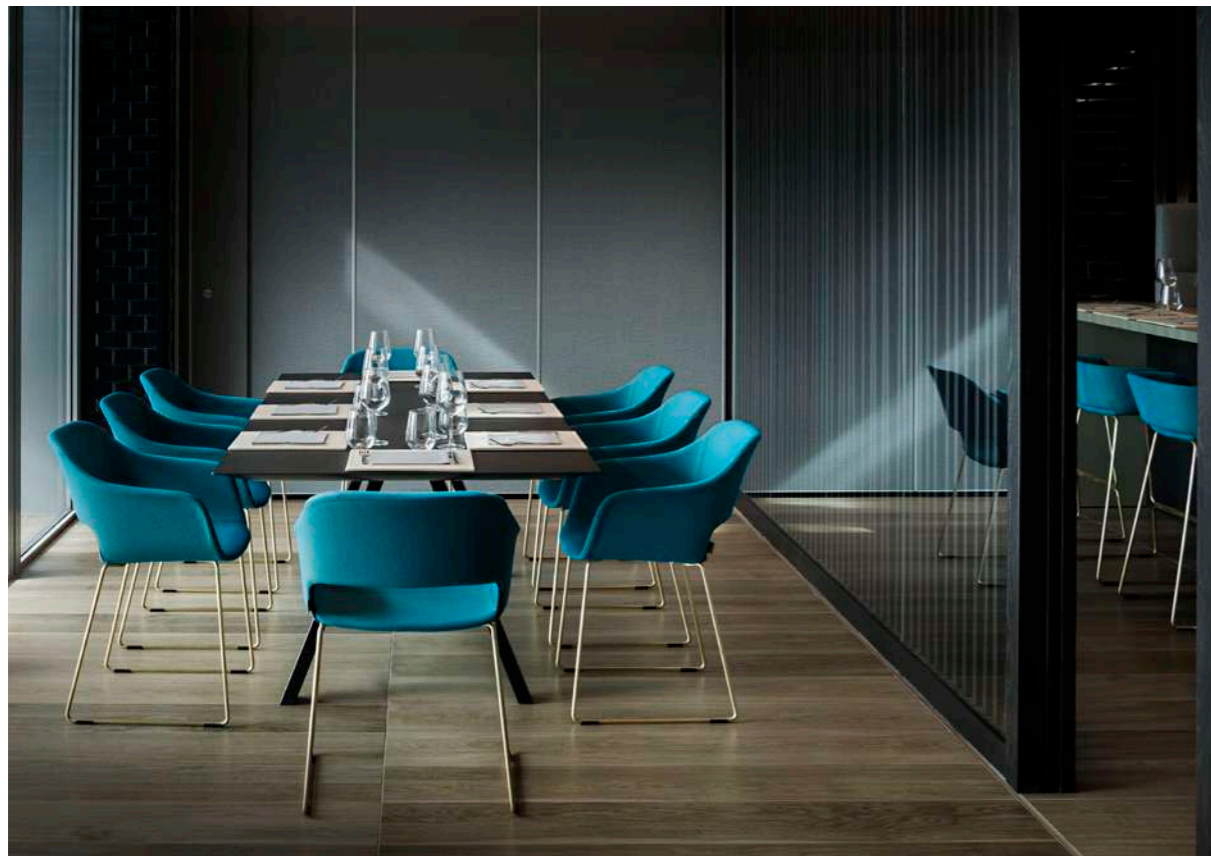

Pedrali - new company canteen

Bergamo, Italy

Project: Company Canteen

Architect: Park Associati

Products: Hevea pot-holder, Arki-Table,
Dome side chair, Folk chair, Babila XL armchair, Laja table,
Modus modular seating, Fabbrico table, Volt side chair,
TO.BE lighting



Sky Italia

Milan, Italy

Project: Office

Architects: DEGW - brand of Lombardini22
(Interior Design & Space Planning)

Products: Arki-Table, Inox table,
Grace armchair, Modus modular seating

ARK 200/240/300X100

Table, steel legs and aluminium frame, solid laminate or melamine top



ARKW 200/240/300X100

Table, oak legs and aluminium frame, solid laminate top



ARK 240/300/360X120

Table, steel legs and aluminium frame, solid laminate top

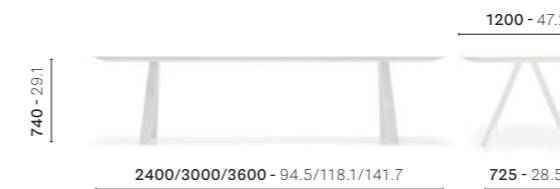

ARKW 240/300/360X120

Table, oak legs and aluminium frame, solid laminate top



ARK 240X120 CCO

Table, steel legs and aluminium frame, solid laminate top, single cable management (600x150 - 23.6x5.9)



ARKW 240X120 CCO

Table, oak legs and aluminium frame, solid laminate top, single cable management (600x150 - 23.6x5.9)



ARK 300/360X120 CCO

Table, steel legs and aluminium frame, solid laminate top, double cable management (600x150 - 23.6x5.9)



ARKW 300/360X120 CCO

Table, oak legs and aluminium frame, solid laminate top, double cable management (600x150 - 23.6x5.9)



ARK 240/300/360X120 CC

Table, steel legs and aluminium frame, solid laminate top, single cable management (1000x42/60 - 39.4x1.6/2.4)



ARKW 240/300/360X120 CC

Table, oak legs and aluminium frame, solid laminate top, single cable management (1000x42/60 - 39.4x1.6/2.4)



ARK 107_200X79

High table, steel legs and aluminium frame, solid laminate top



ARKW 107_200X79

High table, oak legs and aluminium frame, solid laminate top



ARK 107_200X79 CC

High table, steel legs and aluminium frame, solid laminate top, single cable management (800x42/60 - 31.5x1.6/2.4)



ARKW 107_200X79 CC

High table, oak legs and aluminium frame, solid laminate top, single cable management (800x42/60 - 31.5x1.6/2.4)



ARK REG BT 200/240/300x100

Table with adjustable height provided with 1 bluetooth control placed under the tablet top, steel legs and aluminium frame, solid laminate top, single cable management (600x150 - 23.6x5.9)

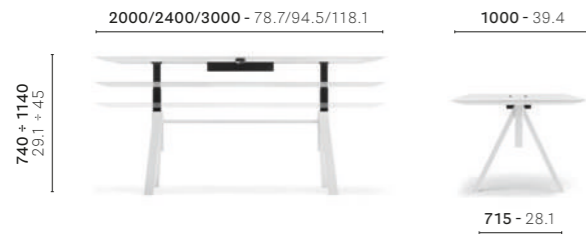

ARKS REG BT 180x79

Table with adjustable height provided with 1 bluetooth control placed under the table top, steel legs and aluminium frame, solid laminate top, single cable management



ARKS.20

Sound absorbing panel



ARK/2_D139

Table, steel legs and aluminium frame, solid laminate top



ARK/2_D149/159

Table, steel legs and aluminium frame, solid laminate top



ARKW/2_D139

Table, oak legs and aluminium frame, solid laminate top



ARKW/2_D149/159

Table, oak legs and aluminium frame, solid laminate top



ARK/2_139X139

Table, steel legs and aluminium frame, solid laminate top



ARK/2_149x149/159x159

Table, steel legs and aluminium frame, solid laminate top



ARKW/2_139x139

Table, oak legs and aluminium frame, solid laminate top



ARKW/2_149x149/159x159

Table, oak legs and aluminium frame, solid laminate top



ARK5/2_D99/109

Table, steel legs and frame, solid laminate or laminate top



ARK5/2_D119/129

Table, steel legs and frame, solid laminate or laminate top

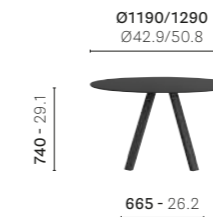

ARKW5/2_D99/109

Table, oak legs and steel frame, solid laminate top

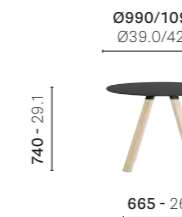

ARKW5/2_D119/129

Table, oak legs and steel frame, solid laminate top



ARK5/2_79X79/89X89/99X99

Table, steel legs and frame, solid laminate or laminate top

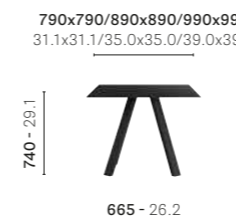

ARK5/2_109x109/119x119

Table, steel legs and frame, solid laminate or laminate top

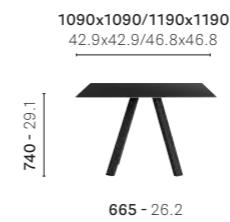

ARKW5/2_79X79/89X89/99X99

Table, oak legs and steel frame, solid laminate top



ARKW5/2_109x109/119x119

Table, oak legs and steel frame, solid laminate top



ARK/2
D139/149/159CCO
Table, steel legs and aluminium frame, solid laminate top, single cable management (160x160 - 6.3x6.3)

Ø1384/Ø1490/Ø1590
Ø54.5/Ø58.7/Ø62.6



ARKW/2
D139/149/159CCO
Table, oak legs and aluminium frame, solid laminate top, single cable management (160x160 - 6.3x6.3)

Ø1384/Ø1490/Ø1590
Ø54.5/Ø58.7/Ø62.6

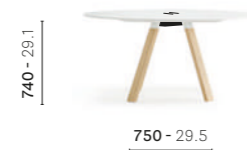

ARK/2
139X139/149X149/159X159CCO
Table, steel legs and aluminium frame, solid laminate top, single cable management (160x160 - 6.3x6.3)

1384x1384/1490x1490/1590x1590
54.5x54.5/58.7x58.7/62.6x62.6



ARKW/2
139X139/149X149/159X159CCO
Table, oak legs and aluminium frame, solid laminate top, single cable management (160x160 - 6.3x6.3)

1384x1384/1490x1490/1590x1590
54.5x54.5/58.7x58.7/62.6x62.6



ARK9
159 X 140
Table, steel legs and aluminium frame, laminate top

159 - 62.6



ARKW9
159 X 140
Table, oak legs and aluminium frame, laminate top

159 - 62.6



ARK9
318 X 140
Table, steel legs and aluminium frame, laminate top

318 - 125.2



ARKW9
318 X 140
Table, oak legs and aluminium frame, laminate top

318 - 125.2



ARK9
477 X 140
Table, steel legs and aluminium frame, laminate top

477 - 187.8



ARKW9
477 X 140
Table, oak legs and aluminium frame, laminate top

477 - 187.8



DSP_L120
Sound absorbing divider panel

1200 - 47.2



DSP/2_L120
Sound absorbing divider panel

1200 - 47.2



FINISHES / FINITURE

solid laminate top / ripiano in stratificato

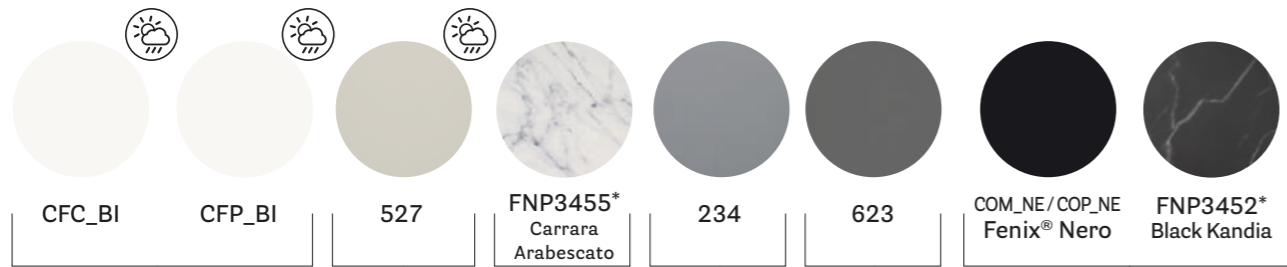

powder-coated legs / gambe in acciaio verniciato

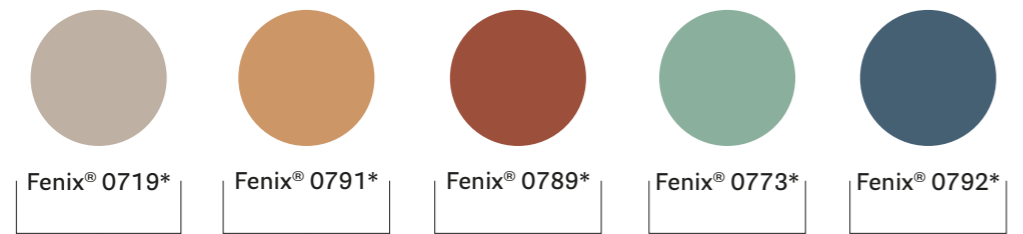

powder-coated legs / gambe in alluminio verniciato

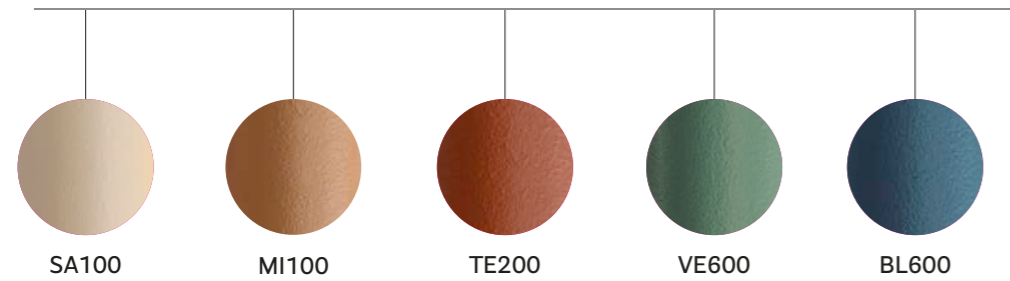

*Anti-fingerprint
Anti-impronta

FINISHES / FINITURE

solid laminate top
ripiano in stratificato



composite marble
agglomerato di marmo



powder-coated legs / gambe in acciaio verniciato



solid laminate top / ripiano in stratificato

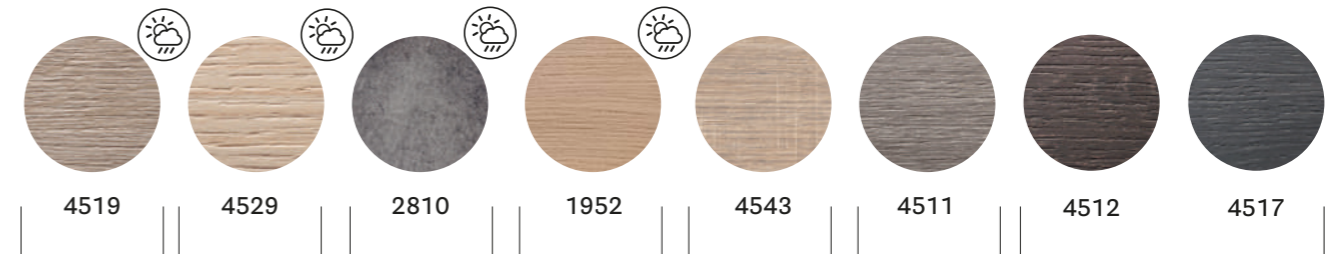

powder-coated legs / gambe in acciaio verniciato

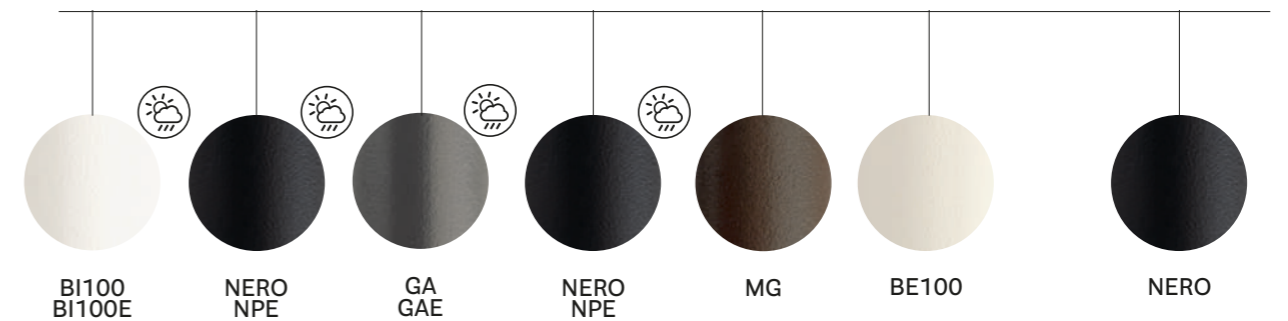

gres top / ripiano in gres



WFN



GFN



IDN

linoleum top / ripiano in linoleum



4132

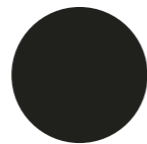

4023

powder-coated legs / gambe in acciaio verniciato



BE100
BE100E



BE200
BE200E

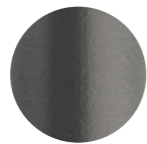

GA
GAE



SA200
SA200E

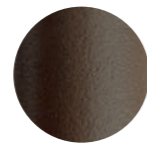

MG
MGE



BE200

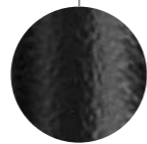

NERO

laminare top / ripiano in laminato



406_0020



4519



4511



4543



4529



4512



4517



Fenix® Nero

powder-coated legs / gambe in acciaio verniciato



BI100



BE100

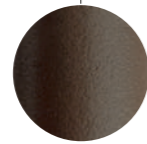

MG

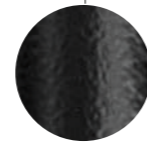

NERO

solid laminate top / ripiano in stratificato



CFP_BI



FNP3455*
Carrara Arabescato

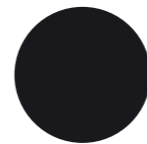

Fenix® Nero

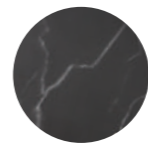

FNP3452*
Black Kandia



Fenix® 0719*

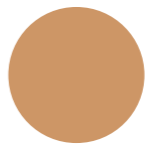

Fenix® 0791*



Fenix® 0789*



Fenix® 0773*

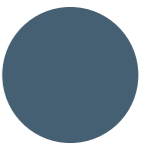

Fenix® 0792*

coated oak legs / gambe in rovere verniciato



RS
Bleached oak
Rovere sbiancato

*Anti-fingerprint
Anti-impronta

linoleum top / ripiano in linoleum



4132

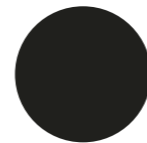

4023



RS
Bleached oak
Rovere sbiancato

laminare top / ripiano in laminato (only for ARK9 AND ARW9)



406_0020



527



RS
Bleached oak
Rovere sbiancato

powder coated / verniciato

→ see booklet for finishes
vedi catalogo finiture

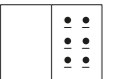

Arki-Desk

A perfect balance

DESIGN
Pedrali R&D, 2020

EN — The Arki-Desk's clean, linear design makes it particularly versatile and suitable for flexible and functional modern corporate and home offices. Steel or solid oak trestle legs are connected together by a steel support, to which the top is fixed for added stability. A more casual and playful version of the Arki-Desk with a coloured frame is also available.

IT — Arki-Desk è un tavolo che, grazie alla sua semplicità, risulta molto versatile, massimizzando la sua capacità di rispondere alle esigenze di flessibilità e funzionalità degli uffici moderni e home office. Le gambe a cavalletto, realizzate in acciaio o in massello di rovere, si collegano ad una traversa in acciaio, alla quale viene fissato il ripiano, garantendo stabilità e aderenza al suolo. Il telaio può essere colorato, rendendo Arki-Desk più informale e giocoso.



HOME OFFICE

Table tavolo Arki-Desk
Task chair sedia operativa Temps low back



Table

Tavolo

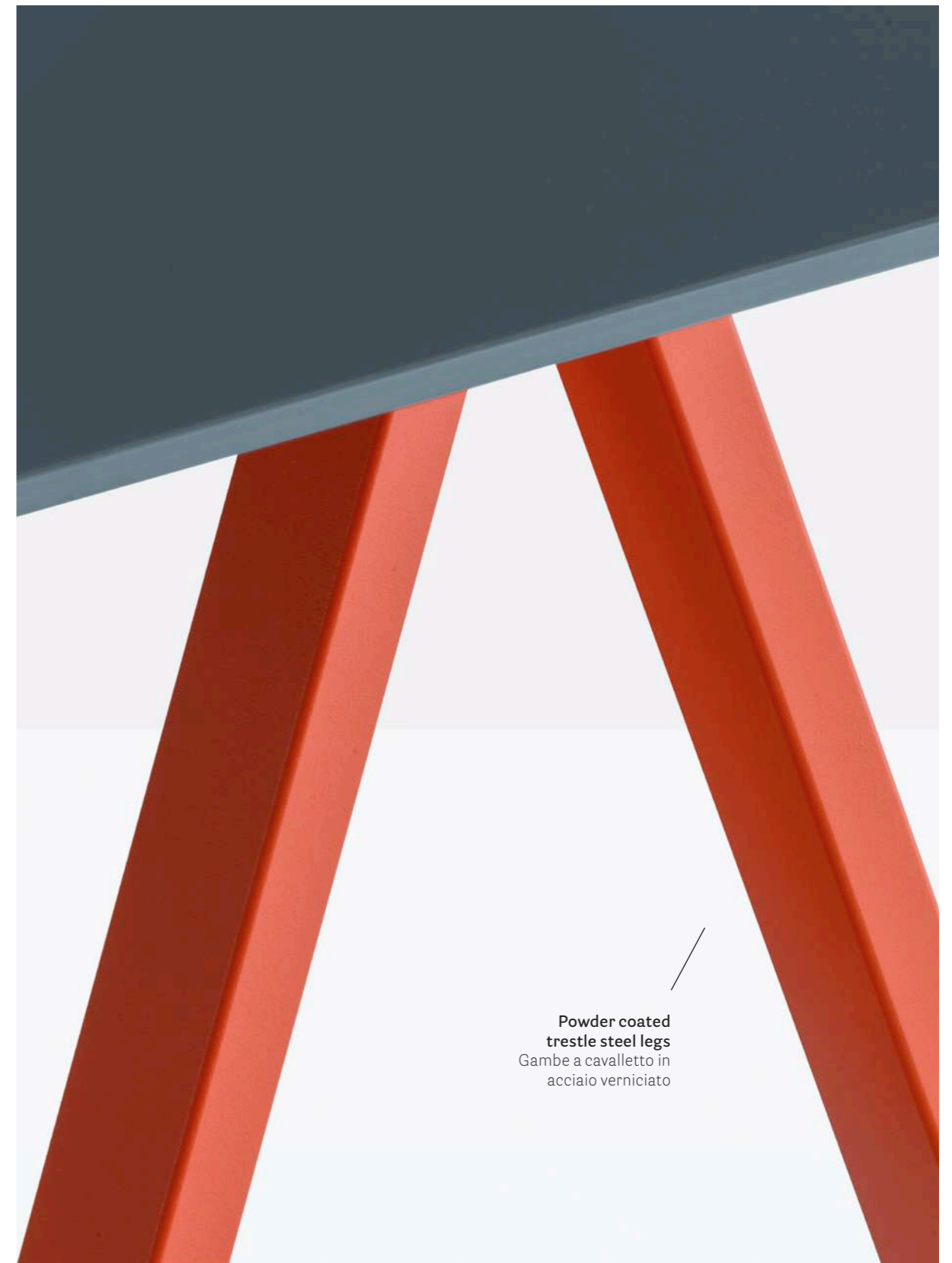



885/2

Top in terracotta fenix and
trestle solid oak legs
Ripiano in fenix terracotta e gambe
a cavalletto in massello di rovere



ARKW7_199X79





#pedralitales

Antwerp, Belgium

Project: 2021 ADV campaign

Products: Temps low back task chair,
Arki-Desk table

Hotel Món Sant Benet de Bages

Barcelona, Spain

Project: Hotel

Architect: Borros Interiorisme

Products: Babila XL armchair, Arki-Desk



ARK7_139X69

Table, steel legs and solid laminate or laminate top



ARK7_159X69

Table, steel legs and solid laminate or laminate top



ARK7_159X79

Table, steel legs and solid laminate or laminate top

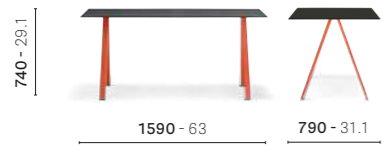

ARK7_179X79

Table, steel legs and solid laminate or laminate top

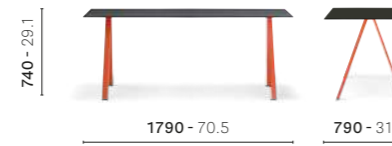

ARK7_199X79

Table, steel legs and solid laminate or laminate top

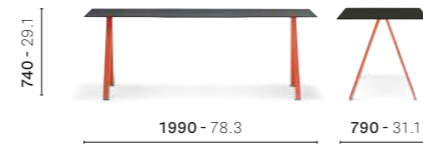

ARKW7_139X69

Table, oak legs and steel frame, solid laminate or laminate top



ARKW7_159X69

Table, oak legs and steel frame, solid laminate or laminate top



ARKW7_159X79

Table, oak legs and steel frame, solid laminate or laminate top



ARKW7_179X79

Table, oak legs and steel frame, solid laminate or laminate top



ARKW7_199X79

Table, oak legs and steel frame, solid laminate or laminate top

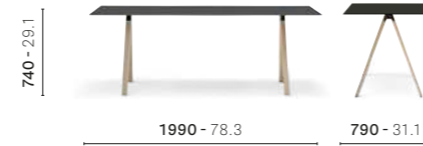

solid laminate top / ripiano in stratificato

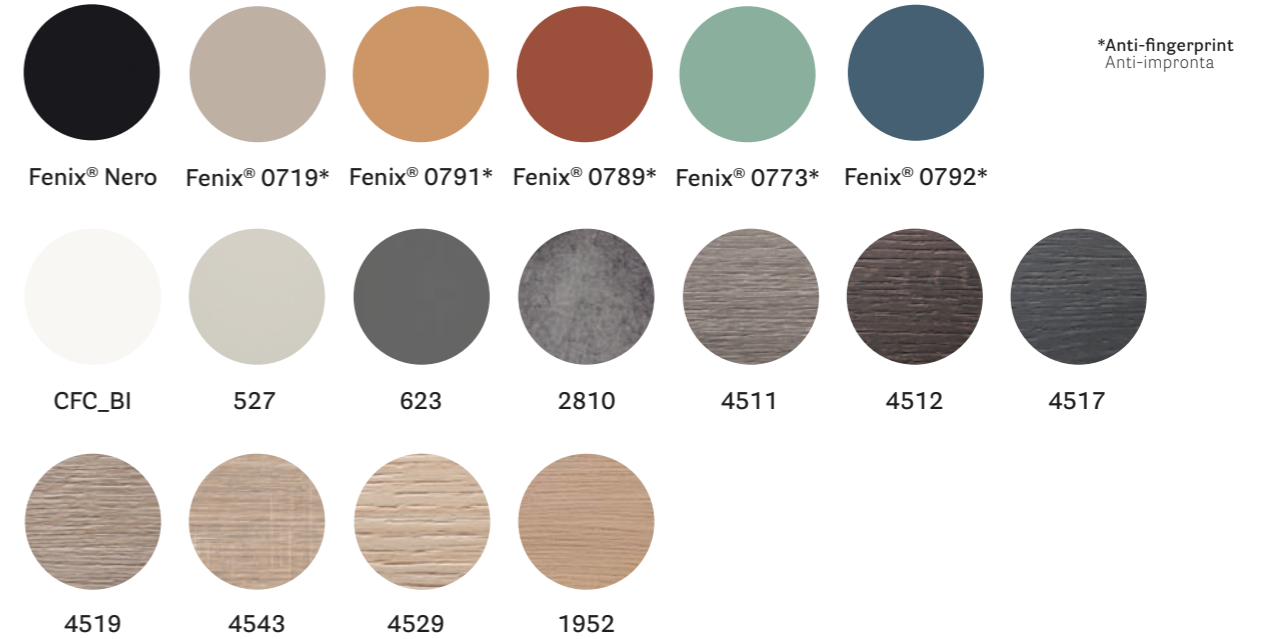

laminate top / ripiano in laminato



coated oak legs / gambe in rovere verniciato



RS
Bleached oak
Rovere sbiancato

powder coated / verniciato

→ see booklet for finishes
vedi catalogo finiture

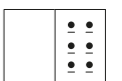

Boxie

Storage in motion

DESIGN

Claudio Dondoli - Marco Pocci, 2018

EN — With its minimal, essential lines, Boxie is remarkable for its lightness, ensured by a steel structure containing drawers, alternated with tops, both made out of polypropylene. Designed to be configured differently according to the selected combination of its elements, the rounded corners and the visible frame are strong points that can be appreciated from any side of Boxie.

IT — Boxie è un sistema contenitore dai tratti essenziali e minimali che si contraddistingue per la sua leggerezza garantita da una struttura in acciaio all'interno della quale vengono collocati cassetti alternati a piani, entrambi realizzati in polipropilene. Pensata per assumere conformazioni diverse in base alla combinazione dei suoi elementi, la rotondità degli angoli e la struttura a vista sono punti di forza apprezzabili da ogni lato di Boxie.





Storage system Sistema contenitore Boxie
Table tavolo Arki-Desk
Armchair poltrona Babila XL
Lighting lampada Giravolta



100% recyclable
100% riciclabile

BXM_3C

Storage system

Sistema contenitore



WOW!House

London, United Kingdom

Project: Temporary installation
Architect and Styling: Fosbury Architecture & Dedar
Products: Noa side chair, Boxie storage system, Nolita coffee table



Studio legale Oberarzbacher e Steckholzer

Bolzano, Italy

Project: Office

Products: Elinor executive chair and table,
Ester armchair, Boxie storage system

SIZES / DIMENSIONI

mm - in

BXL_2C

Polypropylene storage system
2 drawers, steel frame



BXM_3C

Polypropylene storage system
3 drawers, steel frame



BXH_4C

Polypropylene storage system
4 drawers, steel frame



BXL_1C

Polypropylene storage system
1 drawer and 1 top, steel frame



BXM_2C

Polypropylene storage system
2 drawers and 1 top, steel frame



BXH_3C

Polypropylene storage system
3 drawers and 1 top, steel frame



FINISHES / FINITURE

polypropylene in the same colour of the frame / polipropilene in tinta con il telaio

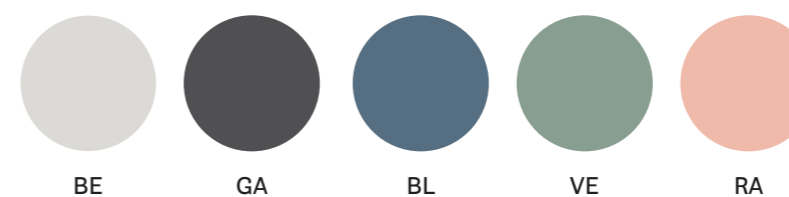

powder coated / verniciato

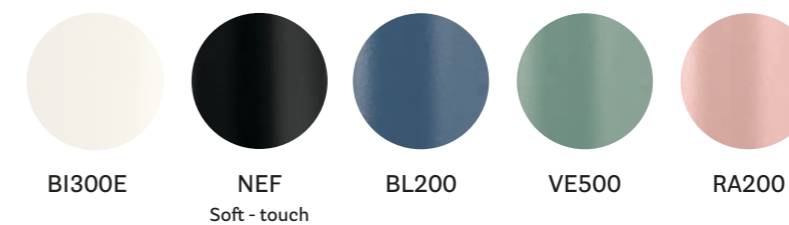

Ypsilon Tilting

Folding table

DESIGN
Jorge Pensi Design Studio, 2018

EN — The Ypsilon table now comes in a new folding, stackable version. Ypsilon is truly versatile and can become a meeting table or a working station in today's latest generation of co-working spaces. At the cutting-edge in terms of quality, it conveys both attention to detail and a high-tech element.

IT — Presentato nella sua nuova versione ribaltabile e accatastabile il tavolo Ypsilon nasce come soluzione versatile per una sala riunioni, capace di trasformarsi in una postazione di lavoro, all'interno dei più recenti format di co-working. Un prodotto qualitativamente all'avanguardia, capace di esprimere cura per il dettaglio e spirito high-tech.



WORKSPACE

Tilting table tavolo ribaltabile Ypsilon Tilting



Table

Tavolo





Version without wheels also available
Disponibile anche nella versione senza ruote



886/2



Porsche Experience Center

Brescia, Italy

Project: Restaurant

Architect: gbpaarchitects

Products: Vic side chair, Arki-Base table, Nemea side chair, Malmö coffee table, Elliot table, Tweet side chair, Ypsilon Tilting table, Remind armchair, Reva lounge armchair and sofa

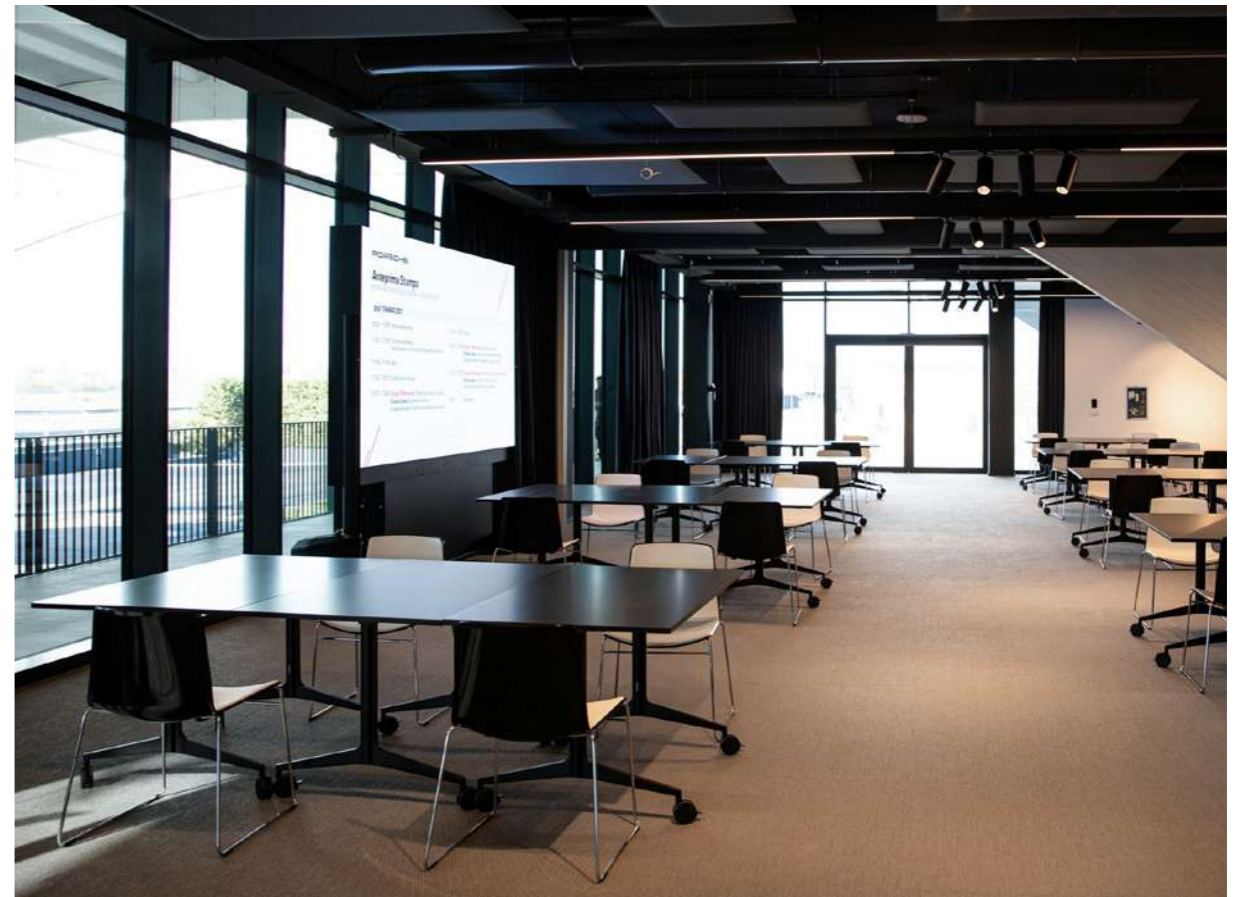

SIZES / DIMENSIONI

TYT

Aluminium tilting office table



FINISHES / FINITURE

laminated top / ripiano in laminato

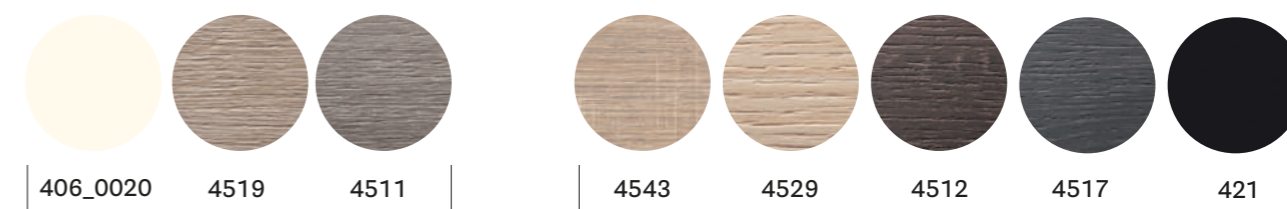

solid laminate top / ripiano in stratificato

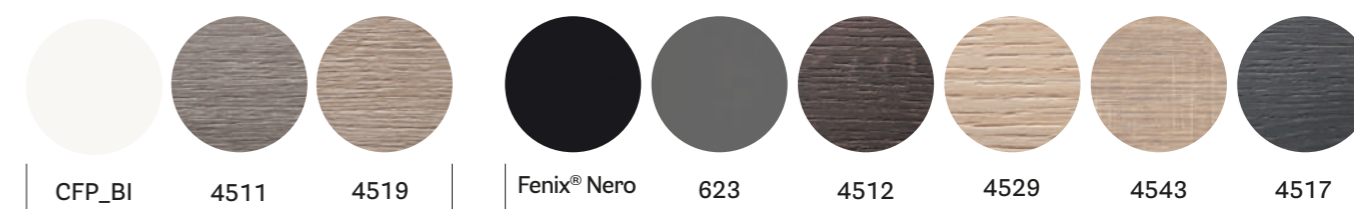

powder-coated or polished legs / gambe in acciaio verniciato o lucidato



AWARDS / PREMI

Biblioteca
Tiraboschi

Bergamo, Italy

Project: Educational

Products: Babila side chair,
Ypsilon Tilting table

Ypsilon Connect

Multifunctional panel

DESIGN

Jorge Pensi Design Studio, 2020

EN — Ypsilon Connect is an elegant and functional self-supporting, sound absorbing partition panel characterised by sound absorbing panels that are shaped around a structure formed by two die-cast aluminium bases and extruded aluminium columns. One of the greatest strengths of this product lies in its extensive customisation possibilities thanks to which users can create ever new layouts, manage their spaces more effectively and create welcoming office spaces or functional training and meeting rooms.

IT — Ypsilon Connect è un elegante e funzionale pannello divisorio fonoassorbente autoportante che si caratterizza per la presenza di pannelli fonoassorbenti sostenuti da una struttura formata da due basi in pressofusione di alluminio e colonne in estruso di alluminio. Punto di forza di questo prodotto è il massimo grado di personalizzazione che offre, definendo abilmente nuovi layout, gestendo gli spazi e riadattando gli uffici a situazioni di formazione aziendale o meeting room.



Space divider pannello divisorio Ypsilon Connect



Space divider pannello divisorio Ypsilon Connect
Side chair sedia Nym Soft



Space divider pannello divisorio Ypsilon Connect
Table tavolo Ypsilon Tilting
Task chair sedia operativa Temps
Lighting lampada Giravolta



Free standing acoustic panel on castors
Pannello fonoassorbente autoportante su ruote

YC_L110

Space divider Pannello divisorio

Optional shelves
Mensole opzionali



Structure formed by two die-cast aluminium bases and extruded aluminium columns
Struttura formata da due basi in pressofusione di alluminio e colonne in estruso di alluminio

YC_L150+YC01+YC02



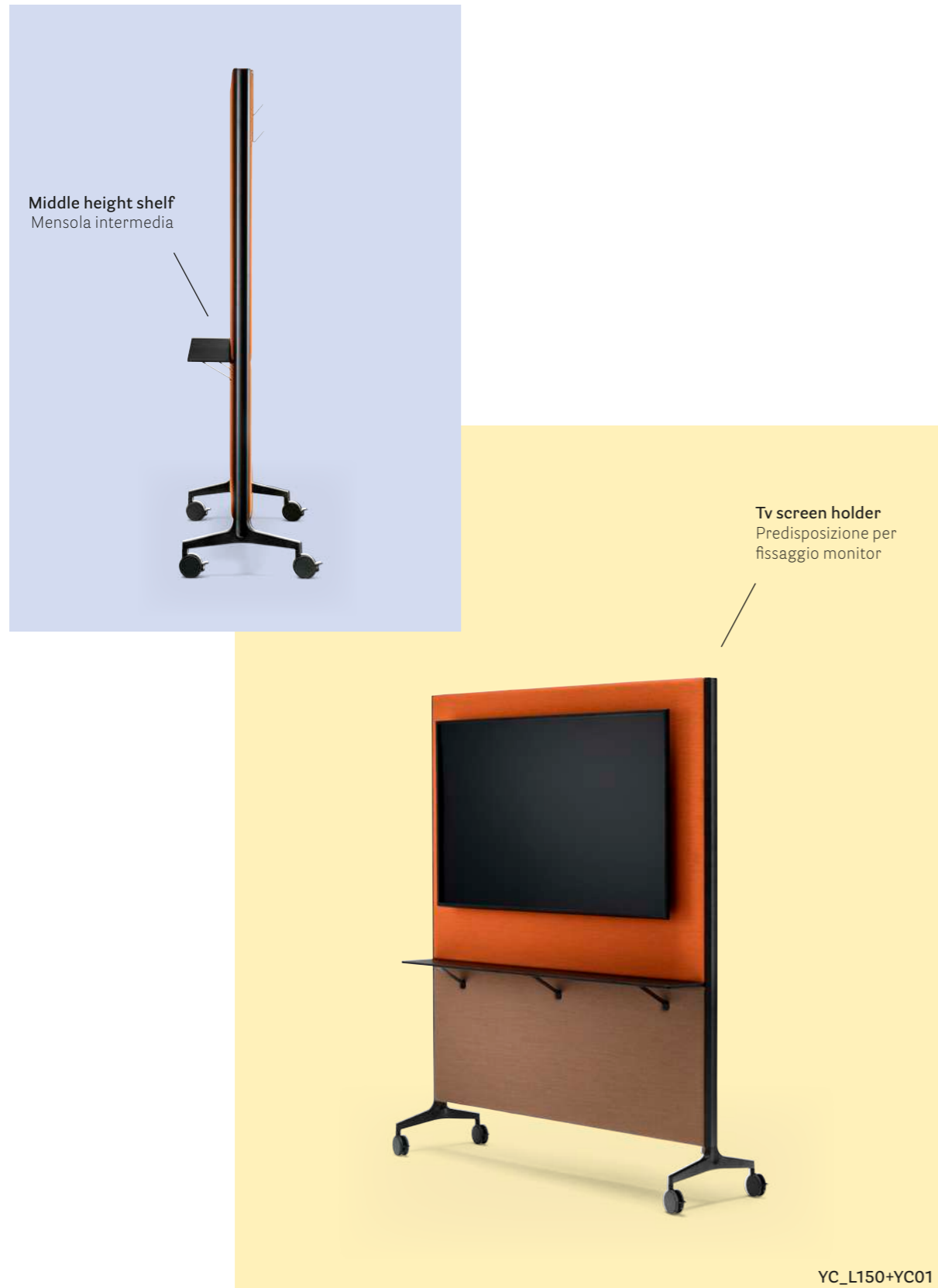



Pedrali collaborative space

Bergamo, Italy

Project: Headquarters

Architects: Park Associati

Products: Ypsilon Connect space divider, Laja armchair, Arki-Table, Toa table, Nemea side chair

Workspaces Design Show

London, United Kingdom

Project: Exhibition stand

Products: Ypsilon Connect space divider, Toa table, Toa Folding Screen desktop panel, Boxie storage system, Babila XL armchair, Hevea pot-holder, Buddyhub desk, Arki-Stool barstool, Reva Cocoon sofa

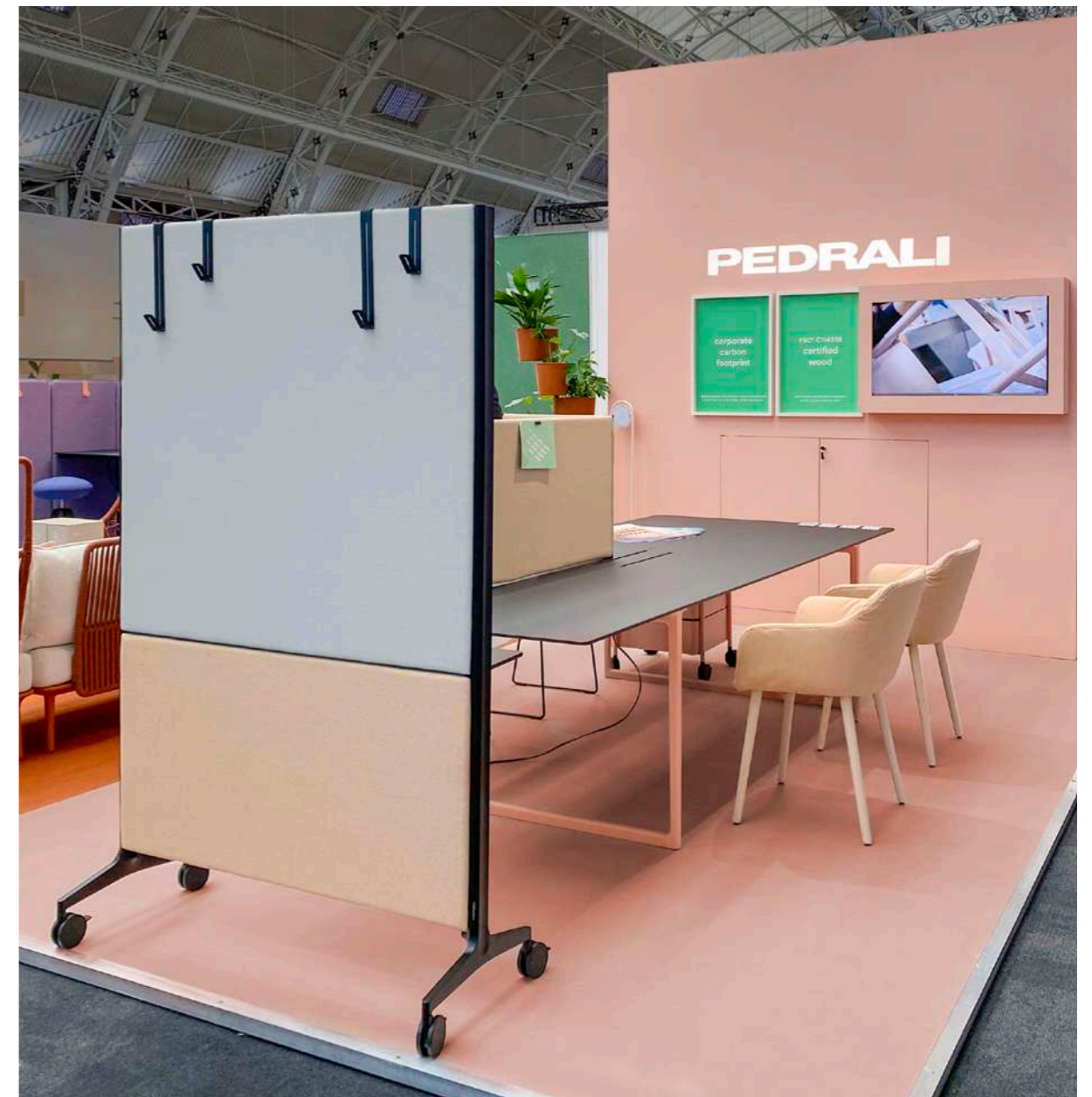

#PedraliWorkspaces

Orgatec 2022
Cologne, Germany

Project: Exhibition stand

Products: Ypsilon Connect space divider,
Elinor low back executive chair, Laja armchair



YC_L110

Space divider, aluminium structure with castors



YCL_L110

Space divider with magnetic whiteboard, aluminium structure with castors



YC_L150

Space divider, aluminium structure with castors



YCL_L150

Space divider with magnetic whiteboard, aluminium structure with castors



YC

on castors



YCF

on feet



YC06

Hooks set



YC01

Middle height shelf

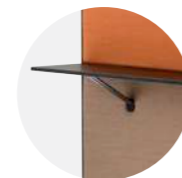

YC02

Upper two-tier shelves

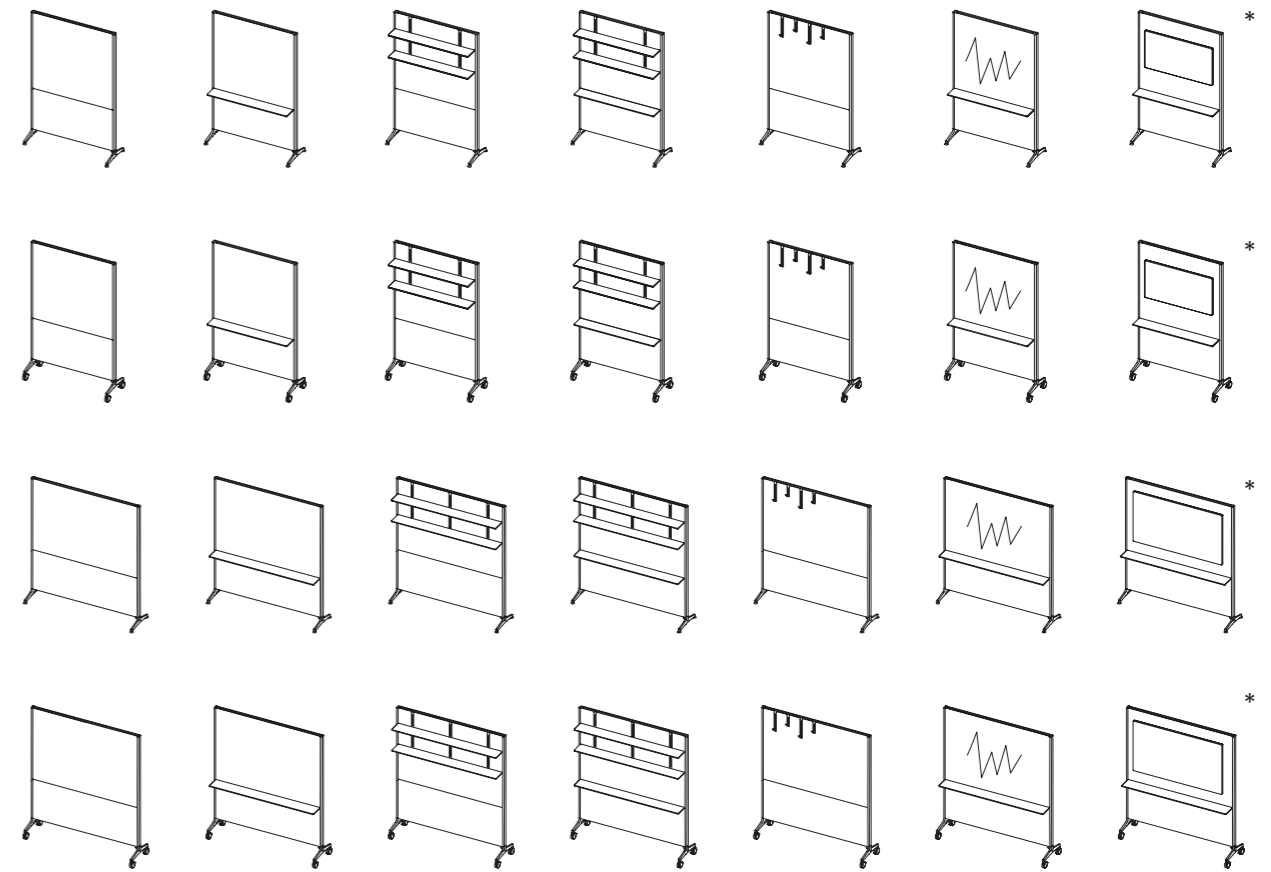

*TV screen / monitor

FINISHES / FINITURE

aluminium / alluminio

powder coated / verniciato

solid laminate / stratificato



LU
Polished
Lucidato



BI100

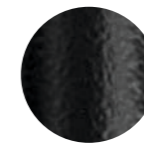

NERO

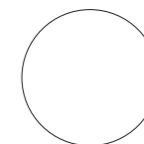

CFP_BI



FNP_NE
Anti-fingerprint finish
Finitura anti-impronta

fabrics / tessuti

→ see booklet for finishes
vedi catalogo finiture

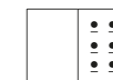

CERTIFICATES / CERTIFICAZIONI

EN ISO 354:2003 Reverberation rooms - Sound test
EN ISO 354:2003 Camera riverberante, test acustico

UNI EN ISO 11654:1997 Rating of sound absorption
UNI EN ISO 11654:1997 Valutazione dell'assorbimento acustico

IMQ CERTIFICATE / CERTIFICATO IMQ
Test report 0064\DC\VACU\21_2 / Rapporto di prova 0064\DC\VACU\21_2

Babila

Reloaded memory

DESIGN
Odo Fioravanti, 2013

EN — Babila collection is able to move along tradition and innovation with great agility. A family of seatings and tables whose strength is its simplicity and directness, to recall a timeless shape.

IT — La collezione Babila si muove con grande agilità tra tradizione e innovazione. Una famiglia di sedute e tavoli la cui forza è nella semplicità e immediatezza, a ricordare una forma senza tempo.



Armchair poltrona Babila
Table tavolo Babila
Lighting lampada L001
Pouf Wow



Side chair

Sedia



Armchair

Poltrona



Comfort armchair
Poltrona comfort

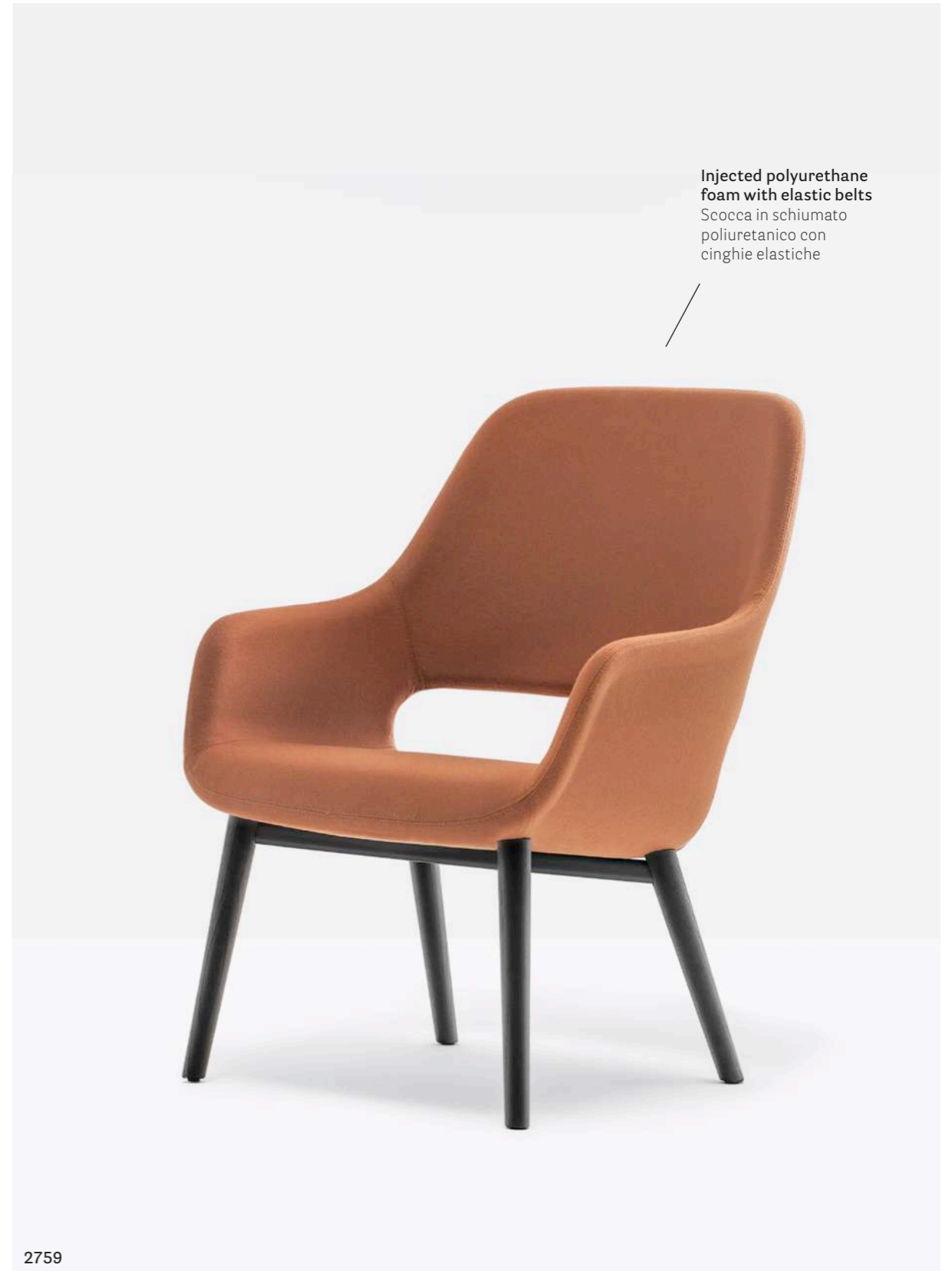

Injected polyurethane
foam with elastic belts
Scocca in schiumato
poliuretano con
cinghie elastiche



Swivel seat with
spring back device
Seduta girevole con
meccanismo di ritorno

Barstool

Sgabello

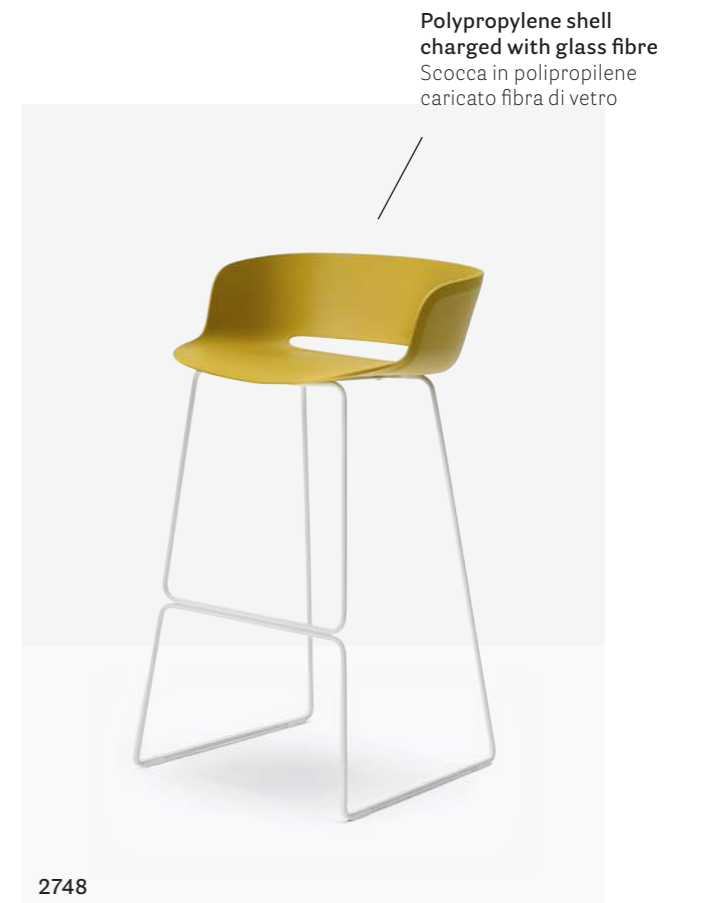
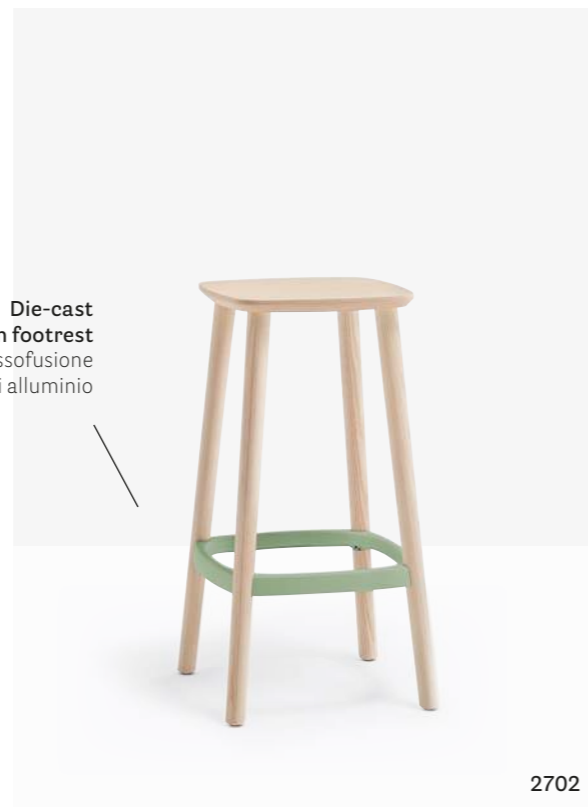
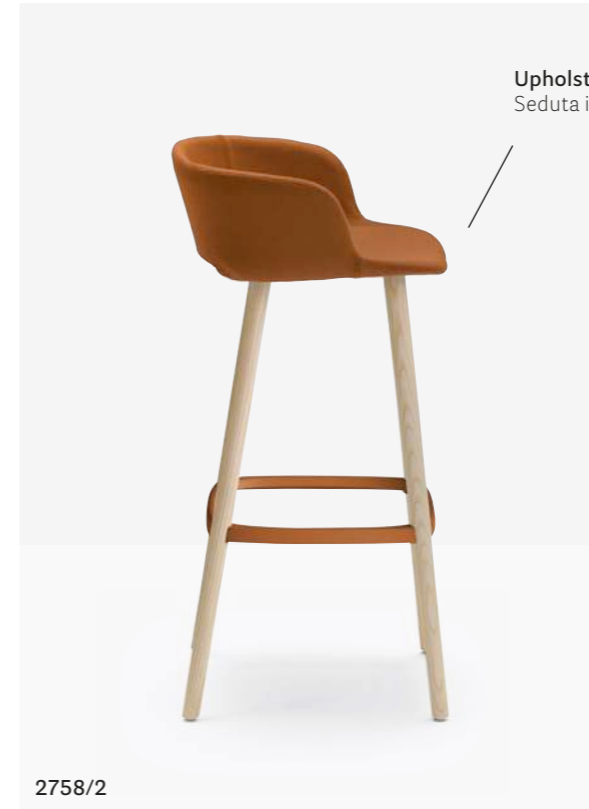

Armchair poltrona Babila
Side chair sedia Babila
Table tavolo Babila



Table
Tavolo



Extruded aluminium frame
with die-cast aluminium supports
Telaio in estruso con supporti
in pressofusione di alluminio

TBA240X100CC + 2756

TABLE / TAVOLO



TABLE / TAVOLO





Edilporte Headquarter

Brescia, Italy

Project: Office

Architect: ZDA | Zupelli Design
Architettura

Products: Babila armchair,
Kuadro table

Grey Workplace

Ljubljana, Slovenia

Project: Office

Architect: Kragelj Arhitekti

Products: Babila side chair and armchair



Edelman's

Dubai, UAE

Project: Office
Architect: Roar Design
Product: Babila side
chair and table



Torre Sasseti S32 Fintech Distric

Milan, Italy

Project: Office
Architect: L22 Urban&Building
Interior design: DEGW
Products: Babila armchair



Wix Campus

Tel Aviv, Israel

Project: Company Canteen
 Products: Babila stool,
 Tribeca side chair

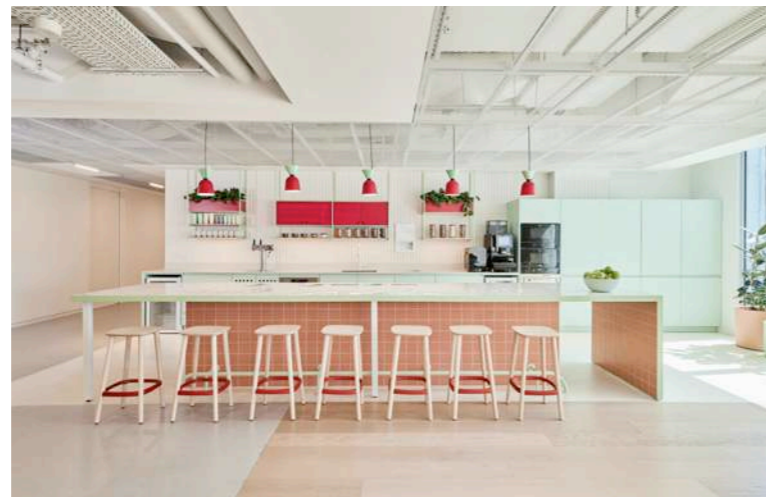

Kilometro Rosso

Bergamo, Italy

Project: Company Canteen
 Architect: Luca Bombassei Studio
 Products: Babila barstool



Spazio Te

Mantova, Italy

Project: Library

Products: Babila side chair



SBS Company Canteen

Turin, Italy

Project: Company Canteen

Architect: Studio Primatesta

Interior Designer: Studio Cristina Quirico

Products: Babila side chair, Stylus table

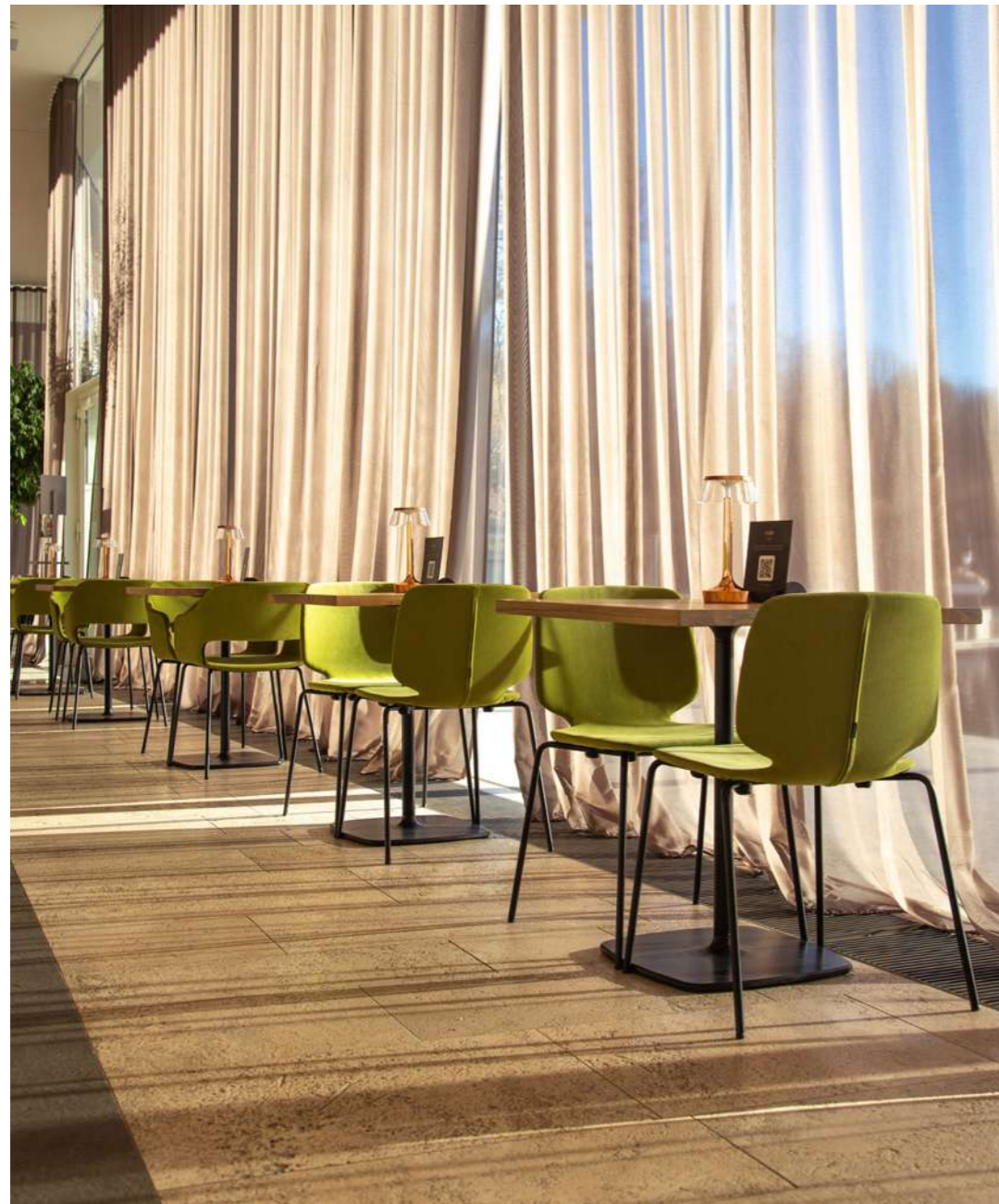

SIZES / DIMENSIONI

mm - in

2700

Side chair, solid ash wood legs, ash plywood shell



2700/A

Side chair, solid ash wood legs, ash plywood shell, upholstered seat



2710

Side chair, ash plywood shell, steel tube frame



2710/A

Side chair, ash plywood shell with upholstered seat, steel tube frame



2720

Side chair, ash plywood shell, steel rod sled frame



2720/A

Side chair, ash plywood shell with upholstered seat, steel rod sled frame



2730

Side chair, technopolymer shell, steel tube frame



2730/A

Side chair, technopolymer shell with upholstered seat, steel tube frame



2740

Side chair, technopolymer shell, steel rod sled frame



2740/A

Side chair, technopolymer shell with upholstered seat, steel rod sled frame



2750

Side chair, technopolymer shell, solid ash wood legs



2750/A

Side chair, technopolymer shell, solid ash wood legs with upholstered seat



2731
Side chair, upholstered shell,
steel tube frame



2741
Side chair, upholstered shell,
steel rod sled frame



2751
Side chair, upholstered shell,
solid ash wood legs



2735
Armchair, polypropylene shell,
steel tube frame



2745
Armchair, polypropylene shell,
steel rod sled frame



2755
Armchair, polypropylene shell,
solid ash wood legs



2736
Armchair, upholstered shell,
steel tube frame



2746
Armchair, upholstered shell,
steel rod sled frame



2756
Armchair, upholstered shell,
solid ash wood legs



2765
Armchair, polypropylene shell,
stainless steel base



2766
Armchair, upholstered shell,
stainless steel base



2775
Armchair, polypropylene shell, die-cast
four-spoke aluminium base with castors



2776
Armchair, upholstered shell, die-cast
four-spoke aluminium base with castors



2759
Lounge armchair, upholstered
shell, solid ash wood legs



2749
Lounge armchair, upholstered
shell, steel rod sled frame



2789
Lounge armchair, upholstered shell,
die-cast four-spoke aluminium base



2702
Ash wood barstool,
aluminium footrest



2702/A
Ash wood barstool,
upholstered seat,
aluminium footrest



2706
Ash wood barstool,
aluminium footrest



2706/A
Ash wood barstool,
upholstered seat,
aluminium footrest



2703
Ash wood low stool



2703/A
Ash wood low stool,
upholstered seat



2747
Barstool, polypropylene shell, steel rod sled frame



2748
Barstool, polypropylene shell, steel rod sled frame



2757
Ash wood barstool, polypropylene shell, aluminium footrest



2758
Ash wood barstool, polypropylene shell, aluminium footrest



2747/2
Barstool, upholstered seat, steel rod sled frame



2748/2
Barstool, upholstered seat, steel rod sled frame



2757/2
Ash wood barstool, upholstered seat, aluminium footrest



2758/2
Ash wood barstool, upholstered seat, aluminium footrest



TBA_90X90
Table, ash wood legs, aluminium frame, Fenix® or solid laminate top



TBA D139
Table, ash wood legs, aluminium frame, Fenix® or solid laminate top



TBA 160/200x90
Table, ash wood legs, aluminium frame, Fenix® or solid laminate top



TBA 200/240/300x100
Table, ash wood legs, aluminium frame, Fenix® or solid laminate top



TBA 200/240x100 CC
Table, ash wood legs, aluminium frame, Fenix® or solid laminate top, single cable management (1000x42/60 - 39.4x1.6/2.4)



TBA/2_139X139
Outdoor table, steel tube legs, aluminium frame, solid laminate top



TBA/2_D139
Outdoor table, steel tube legs, aluminium frame, solid laminate top



TBA/2_D159
Outdoor table, steel tube legs, aluminium frame, solid laminate top



TBA/2_90/160/200x90
Outdoor table, steel tube legs, aluminium frame, solid laminate or composite marble top



TBA/2_200/240/300x100
Outdoor table, steel tube legs, aluminium frame, solid laminate, composite marble or gres top



coated ash / frassino verniciato



FR
Bleached ash
Frassino sbiancato

N1
Light walnut
Noce chiaro

lacquered ash with visible grains / frassino laccato a poro aperto



AN
Black
Nero

BI
White
Bianco

GC
Light grey
Grigio chiaro

lacquered ash with visible grains / frassino laccato a poro aperto

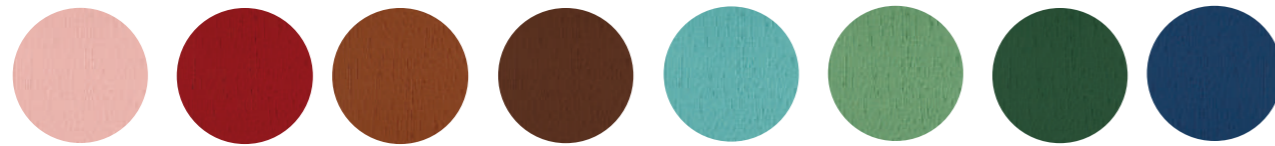

RA
Pink
Rosa

RB
Ruby red
Rosso rubino

MC
Cognac

MO
Mahogany
Mogano

AZ1
Light blue
Azzurro

VE1
Light green
Verde chiaro

VE2
Dark green
Verde scuro

BL2
Dark blue
Blu scuro

stainless steel / acciaio inox

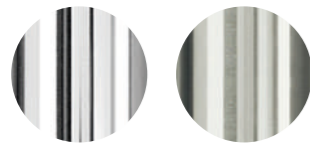

LU
Polished
Lucidato

AC
Brushed
Satinato

steel / acciaio

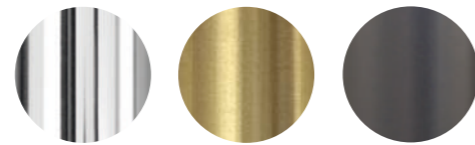

CR
Chromed
Cromato

OA
Antique brass
Ottone anticato

TN
Titanium
Titanio

aluminium / alluminio

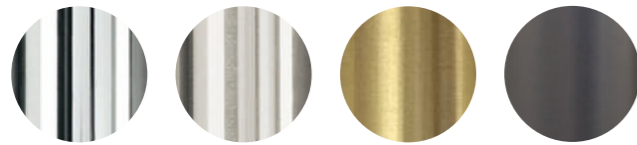

LU
Polished
Lucidato

ST
Satinized
Satinato

OA
Antique brass
Ottone anticato

TN
Titanium
Titanio

powder coated / verniciato

→ see booklet for finishes
vedi catalogo finiture

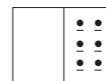

technopolymer / tecnopolimero (Babila side chair)

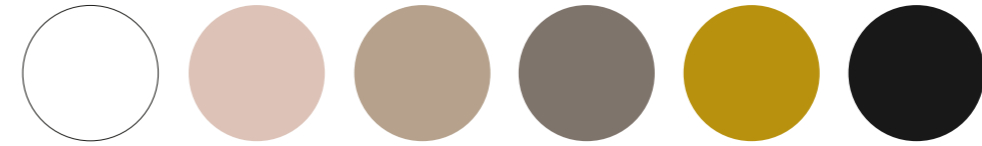

BI **RA2** **SA** **GR** **GI** **NE**

polypropylene / polipropilene (Babila armchair)

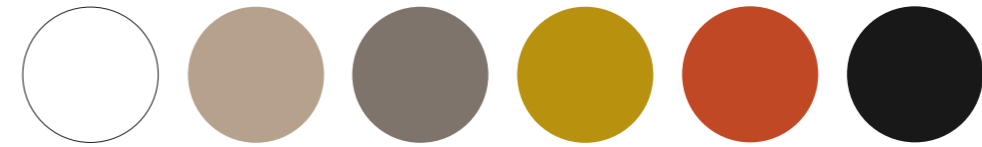

BI **SA** **GR** **GI** **AR** **NE**

fabrics / tessuti

→ see booklet for finishes
vedi catalogo finiture



CERTIFICATES / CERTIFICAZIONI

Safety, strength and durability tests / Prove di sicurezza, resistenza e durata
EN 1728:2012+AC2013 — EN 16139:2013 level 2



For
2750 - 2700 - 2710 - 2720 - 2735
2745 - 2755 - 2765 - 2703 - 2702
2706 - 2747 - 2748 - 2757 - 2758

AWARDS / PREMI



solid laminate top / ripiano in stratificato

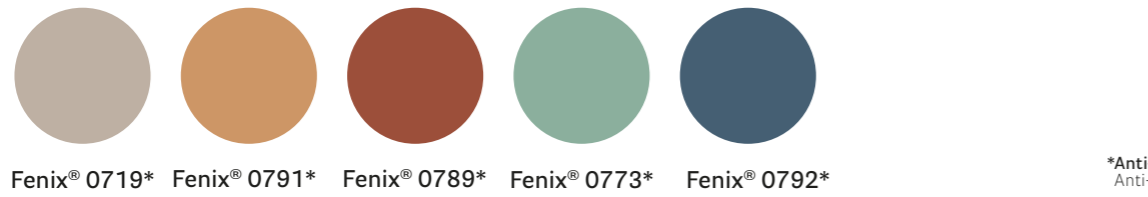
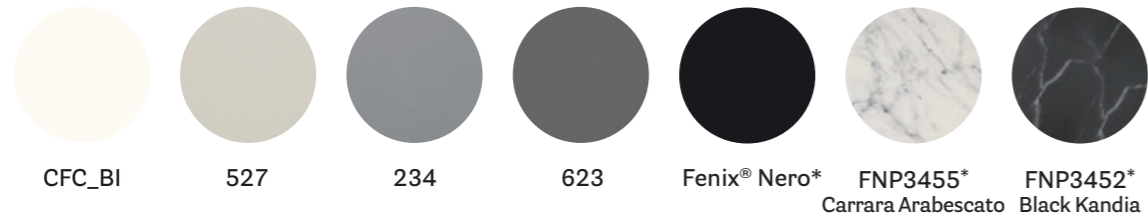

*Anti-fingerprint
Anti-impronta

coated ash legs
gambe in frassino verniciato



lacquered ash legs with visible grains
gambe in frassino laccato a poro aperto



solid laminate top / ripiano in stratificato

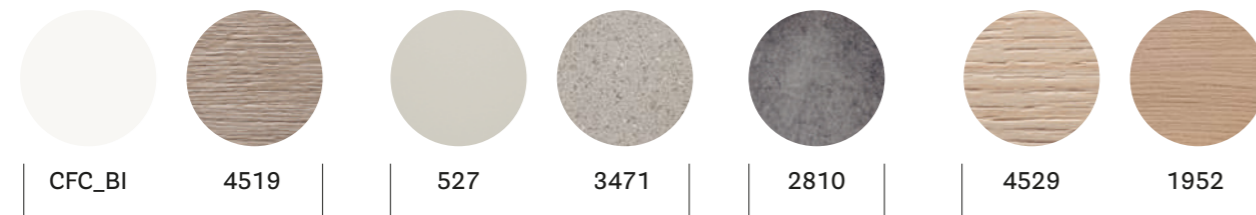

powder-coated legs / gambe in acciaio verniciato



solid laminate top
ripiano in stratificato



composite marble
agglomerato di marmo

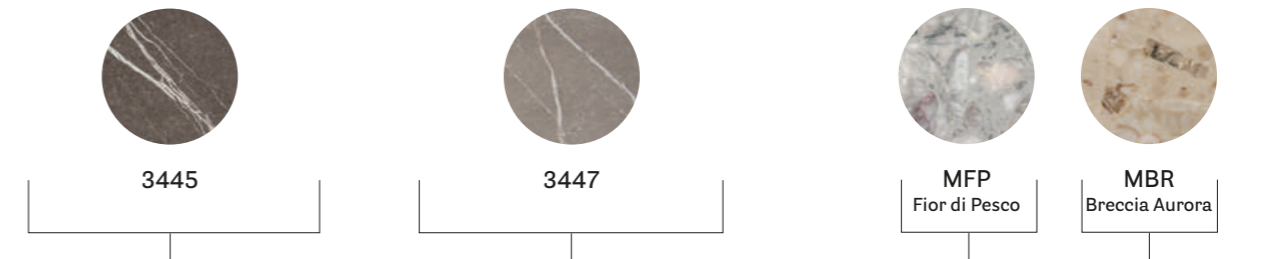

powder-coated legs / gambe in acciaio verniciato



gres top / ripiano in gres

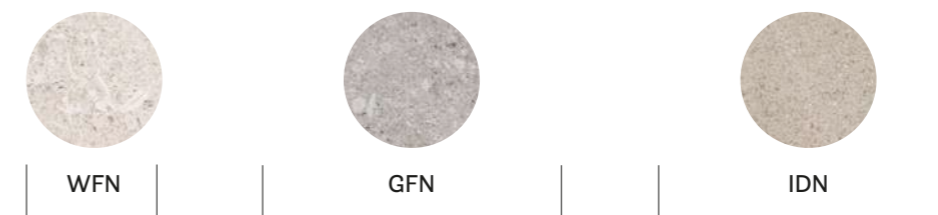

powder-coated legs / gambe in acciaio verniciato

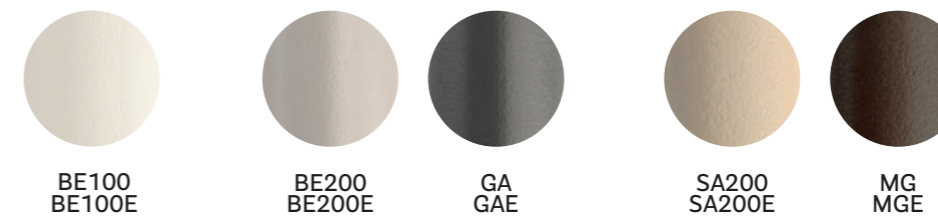

Babila XL

Reloaded memory

DESIGN
Odo Fioravanti, 2020

EN — The Babila XL armchair with a polypropylene shell stands out for the large dimension of its seat and armrests. The aim is to offer greater seating comfort, also through the padded lining recalling a woman's dress. Babila XL "recycled grey" version is one of the first products made from recycled polypropylene: 50% from post-consumer plastic waste and 50% industrial plastic waste.

IT — Babila XL è una poltrona con la scocca stampata in polipropilene che si connota per le dimensioni ampie della seduta e del bracciolo. L'obiettivo è quello di offrire un comfort generoso di seduta, grazie anche al rivestimento imbottito, quasi a ricordare un abito femminile. La versione Babila XL "recycled grey" rappresenta uno dei primi prodotti realizzati in polipropilene riciclato: 50% da scarto di materiale plastico post consumo e 50% da scarto di materiale plastico industriale.



WORKSPACE

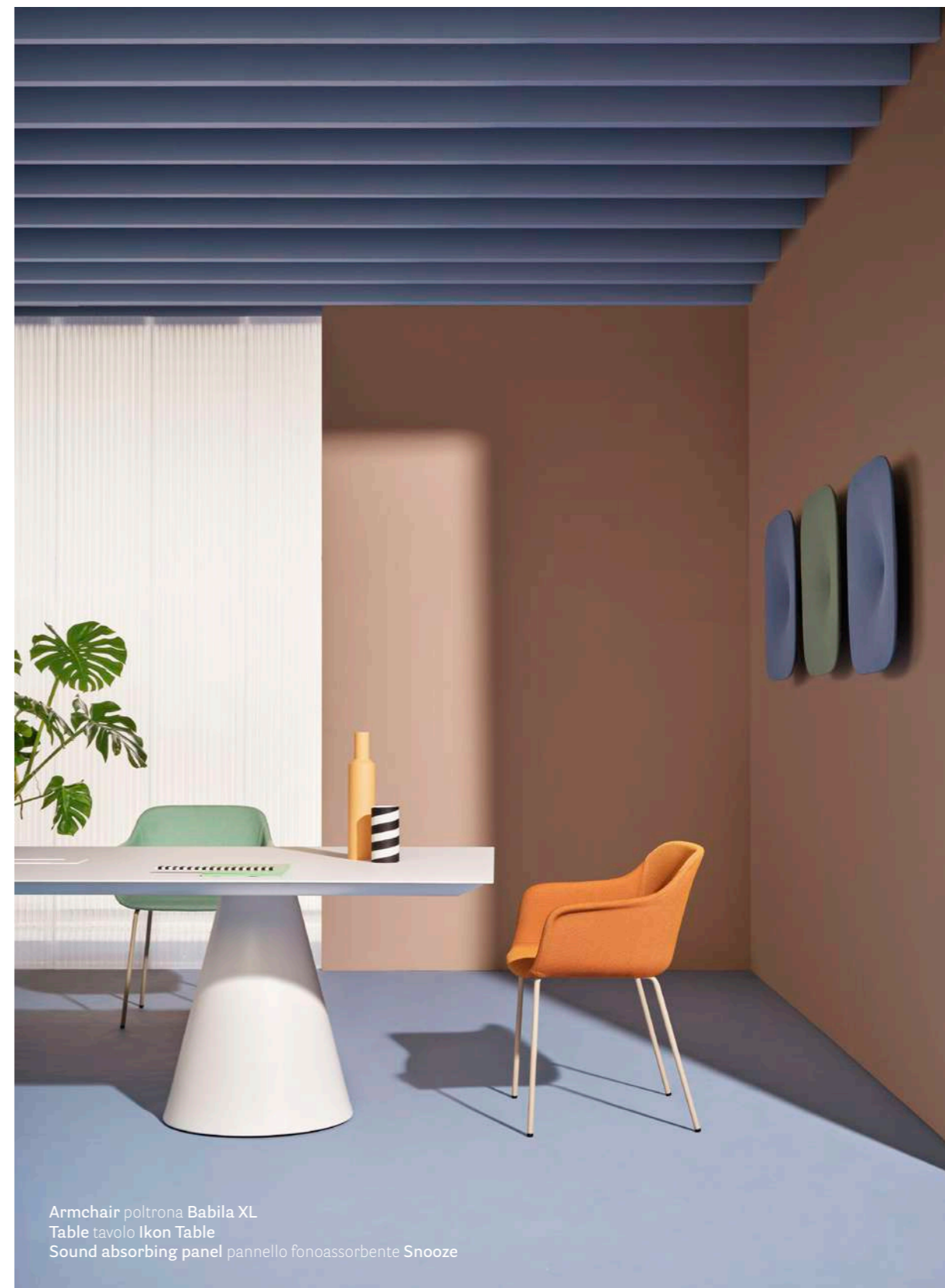

Armchair poltrona Babila XL
Table tavolo Ikon Table
Sound absorbing panel pannello fonoassorbente Snooze

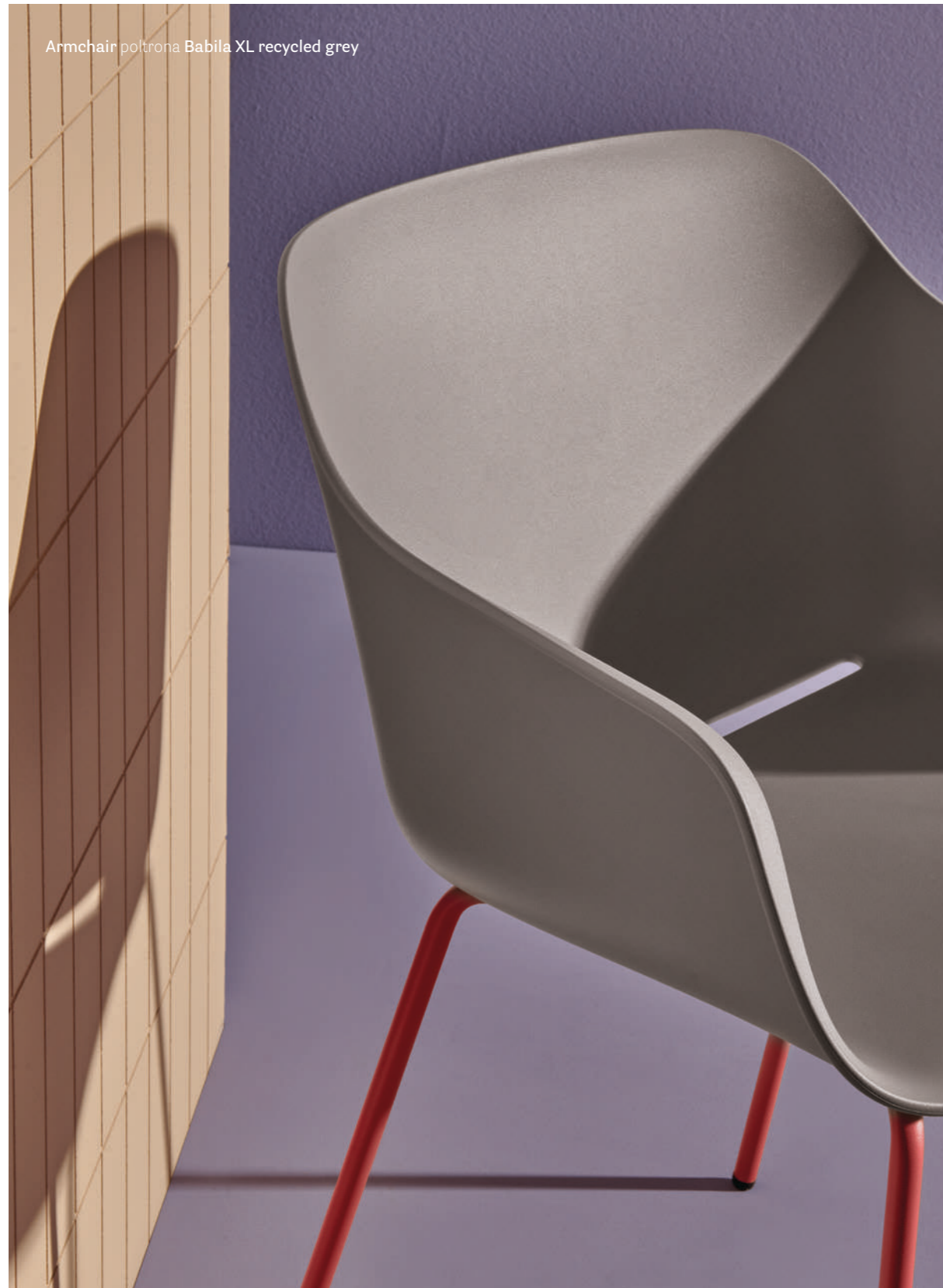

Armchair
Poltrona

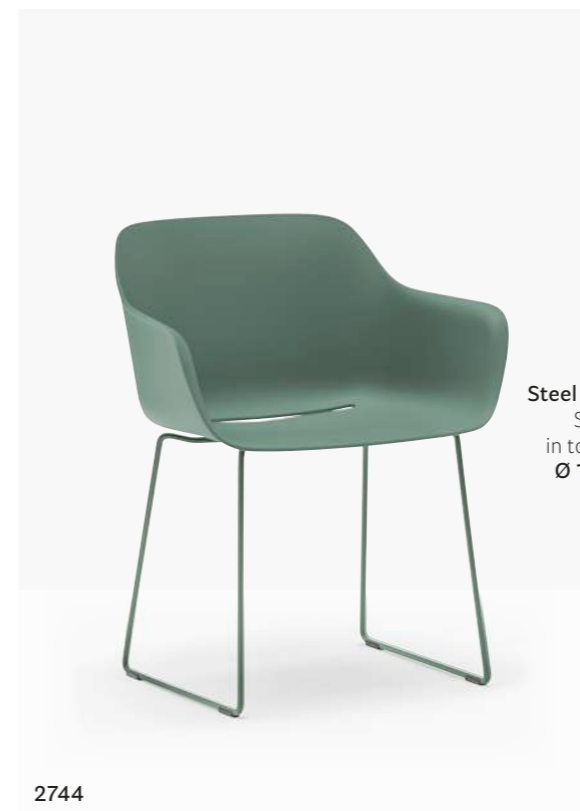

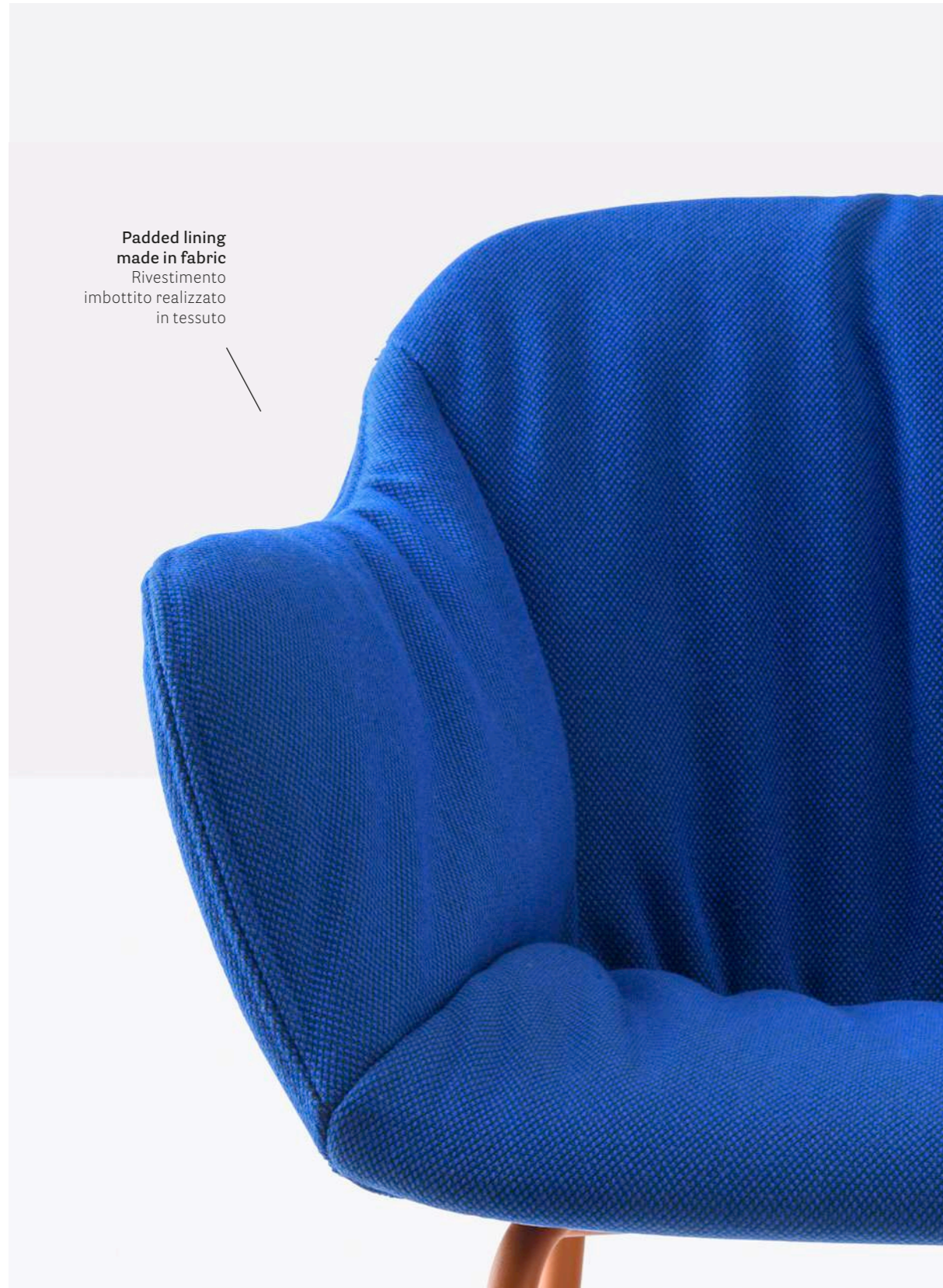

Padded lining
made in fabric
Rivestimento
imbottito realizzato
in tessuto



Legs in solid ash wood FSC® C114358
certified and finished with organic
water-based coatings
Gambe in massello di frassino certificato
FSC® C114358 e verniciato all'acqua con
vernici di origine vegetale

2753R



2733R



Steel tube frame
Tubo d'acciaio
Ø 16 mm - Ø 0.63 in



Upholstered
shell version
Versione con
scocca imbottita



Tronios Almelo head office

Almelo, Netherlands

Project: Company Canteen
Architect: remy meijers
interieurarchitectuur

Products: Babila XL armchair



Hotel Món Sant Benet de Bages

Barcelona, Spain

Project: Hotel
Architect: Borros Interiorisme
Products: Babila XL armchair,
Arki-Table



Pedrali company canteen

Bergamo, Italy

Project: Company Canteen

Architect: Park Associati

Products: Babila XL armchair,
Arki-Table, TO.BE lighting



Happening Offices

Bucharest, Romania

Project: Company Canteen

Products: Babila XL armchair

SIZES / DIMENSIONI

mm - in

2734
Armchair, polypropylene shell,
steel tube frame



2744
Armchair, polypropylene shell,
steel rod sled frame



2754
Armchair, polypropylene shell,
solid ash wood legs



2734R
Armchair, recycled polypropylene shell,
steel tube frame



2744R
Armchair, recycled polypropylene shell,
steel rod sled frame



2754R
Armchair, recycled polypropylene
shell, solid ash wood legs



2732
Armchair, upholstered shell,
steel tube frame



2742
Armchair, upholstered shell,
steel rod sled frame



2752
Armchair, upholstered shell,
solid ash wood legs



2734/3
Upholstered lining only for
polypropylene armchair shell



FINISHES / FINITURE

coated ash / frassino verniciato



lacquered ash with visible grains / frassino laccato a poro aperto



gold lacquered / laccato oro



steel / acciaio



powder coated / verniciato

→ see booklet for finishes
vedi catalogo finiture

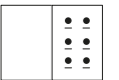

polypropylene / polipropilene

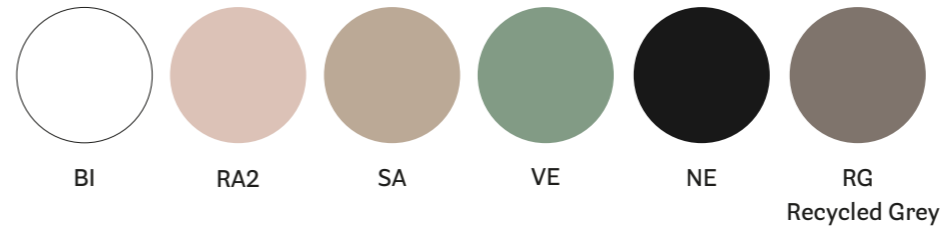

fabrics / tessuti

→ see booklet for finishes
vedi catalogo finiture



CERTIFICATES / CERTIFICAZIONI

Safety, strength and durability tests / Prove di sicurezza, resistenza e durata
EN 1728:2012+AC2013 — EN 16139:2013 level 2



AWARDS / PREMI



Tweet

Eclectic by choice

DESIGN
Marc Sadler, 2013

EN — Tweet is a collection of seatings which combines the rational, clean design of the shell with a wide selection of frames and finishes, to guarantee the best adaptability in contract projects and domestic settings.

IT — Tweet è una collezione di sedute che combina il disegno razionale e pulito della scocca ad un'ampia scelta di telai e finiture, per garantire la massima adattabilità negli ambienti contract e domestici.







Side chair sedia Tweet
Table tavolo Babila



Table tavolo Arki-Table Wood
Side chair sedia Tweet
Armchair poltrona Tweet

Side chair

Sedia

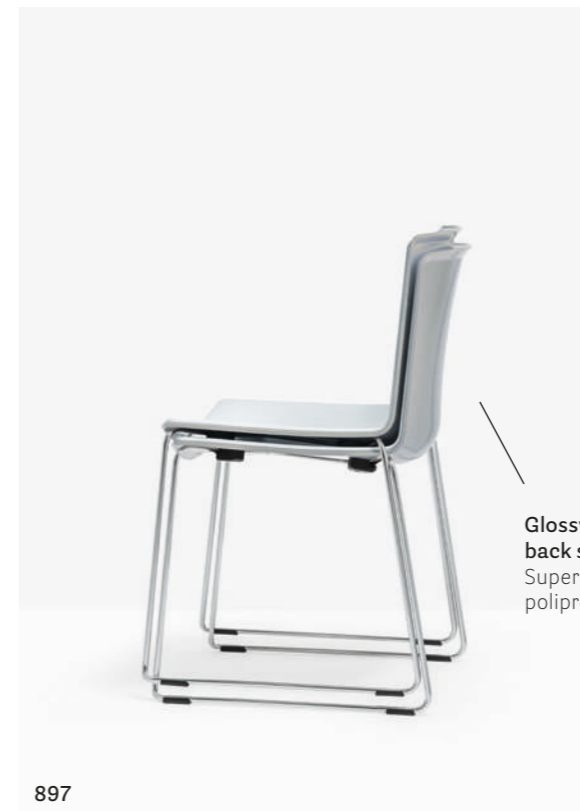
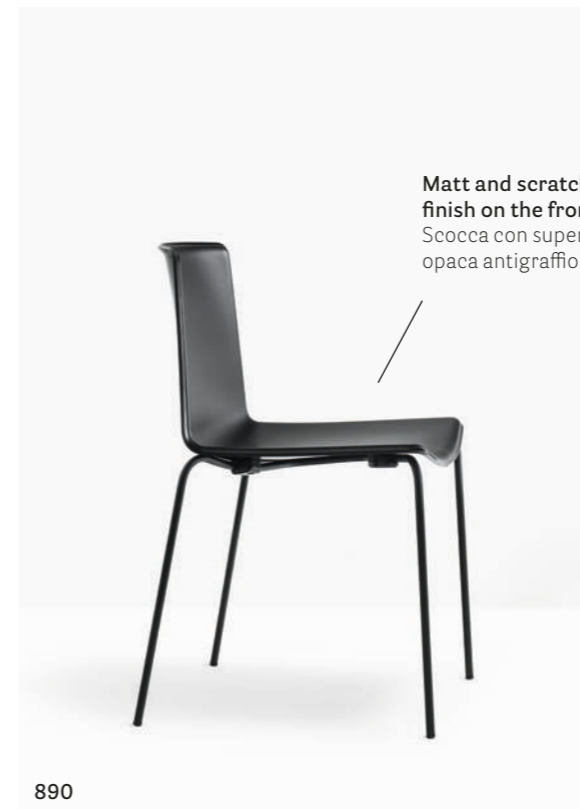



890



897

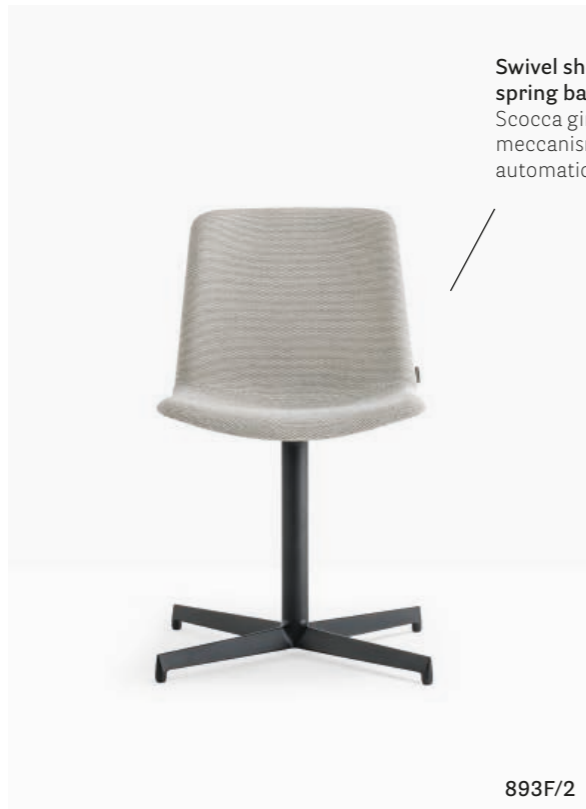

Swivel shell,
spring back device
Scocca girevole con
meccanismo di ritorno
automatico

893F/2

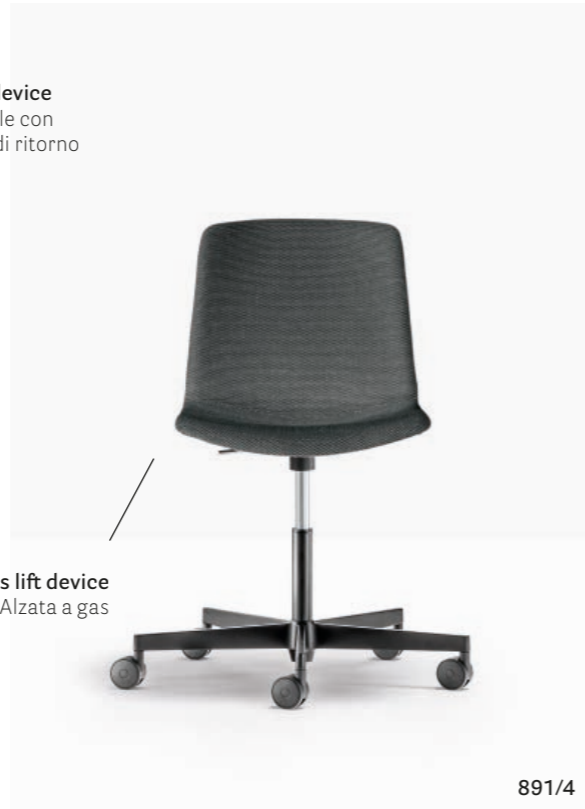

Gas lift device
Alzata a gas

891/4



Stackable
Impilabile

897/2



Side chair with optional tablet sedia con predisposizione tavoletta Tweet



Black Fenix® tablet, thickness
Tavoletta in Fenix® nero, spessore
6 mm - 0.24 in

Steel rod sled frame
Struttura a slitta
in tondino d'acciaio
Ø 11 mm - Ø 0.43 in

894/2 + 894/TT

Side chair with optional tablet

Sedia con
predisposizione
tavoletta



YC_L150

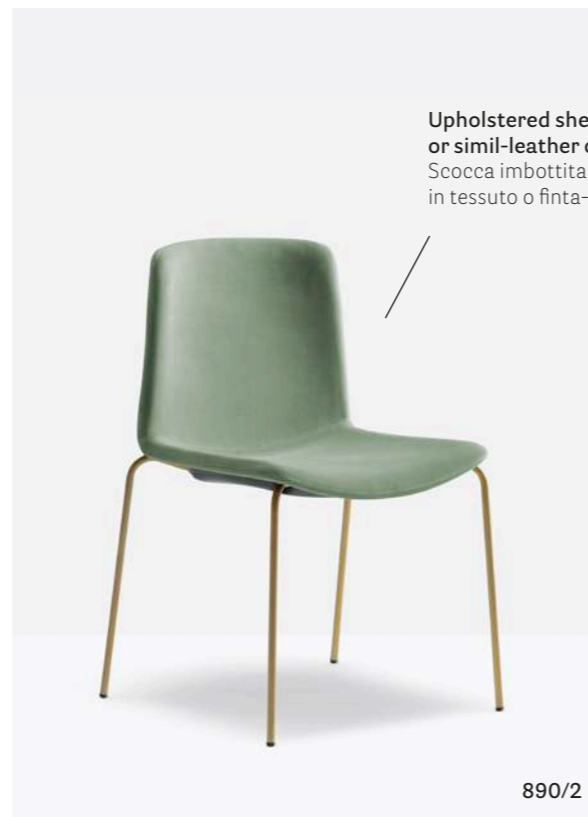

Armchair Poltrona





Upholstered shell and armrests
 Scocca e braccioli imbottiti

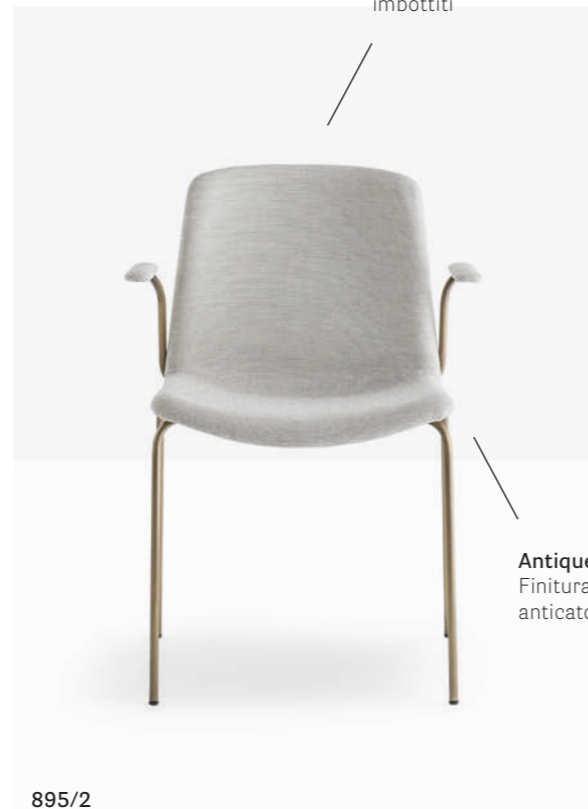

Antique brass finish
 Finitura ottone anticato



Stackable
 Impilabile



Easy-to-handle edge
 Cornice che facilita la presa

Steel rod sled frame
 Struttura a slitta in tondino d'acciaio Ø 11 mm - Ø 0.43 in

Barstool

Sgabello

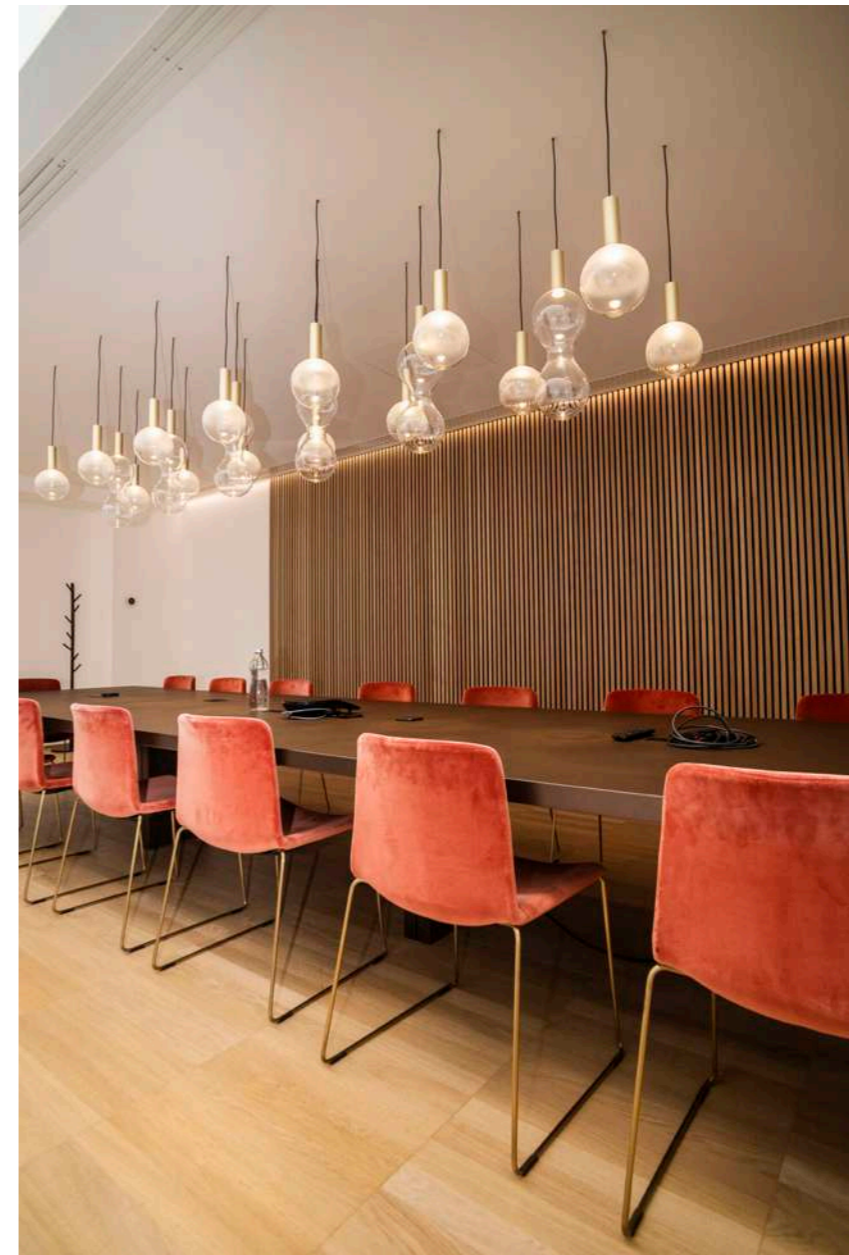
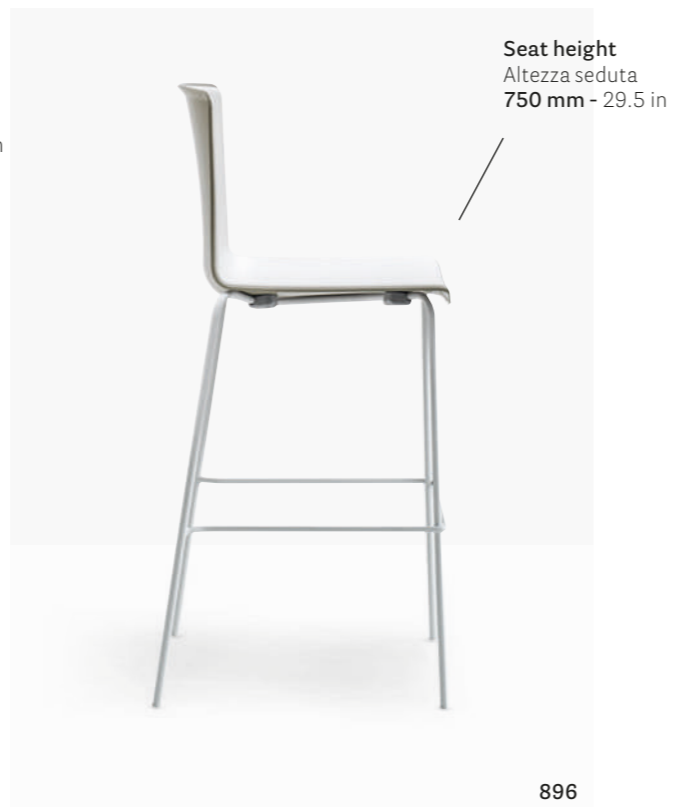
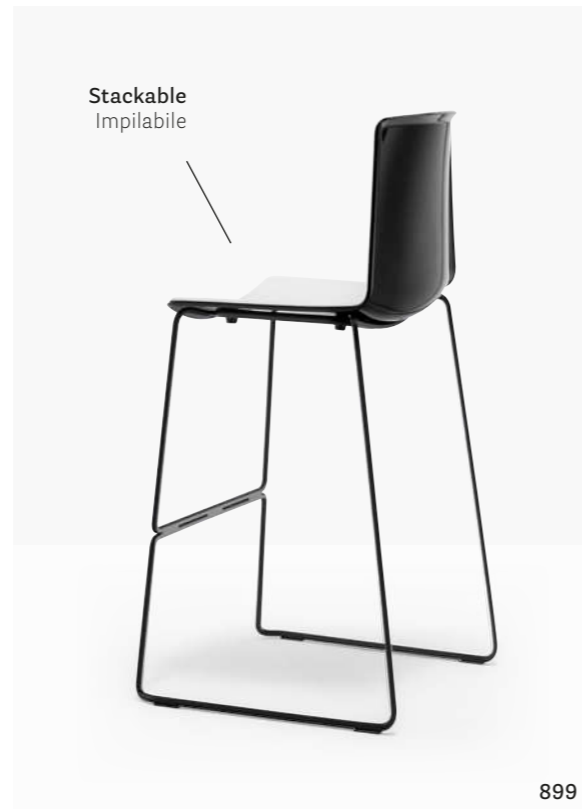

Vi.Co.ok Office

Bergamo, Italy

Project: Office

Products: Tweet side chair

Google Campus

Madrid, Spain

Project: Conference room

Architect: Jump Studios

Product: Tweet side chair



Flow Hotel & Conference

Nagykovacsi, Hungary

Project: Hotel

Products: Tweet side chair



Playster Headquarters

Montréal, Canada

Project: Office

Architect: ACDF Architecture

Product: Tweet barstool



Office Building RAL 7016

Grantorto, Italy

Project: Office

Architect: One Farm Design

Product: Tweet side chair





Mossos d'Esquadra Training Center

Barcelona, Spain

Project: Office

Architect: Albert Martinez
Esteve, Ricard Turon Vich

Products: Tweet side chair,
Arki-Desk table

Bitpanda Office

Vienna, Austria

Project: Office

Interior Designer: Alessandra Cetto

Products: Tweet side chair



Olivia Balmes

Barcelona, Spain

Project: Hotel

Products: Tweet side chair,
Laja armchair, Plus armchair,
Ikon table

Unit 4

Stockholm, Sweden

Project: Office

Products: Tweet barstool and side chair, L001 lighting, Log lounge armchair and pouf, Social Plus modular seating

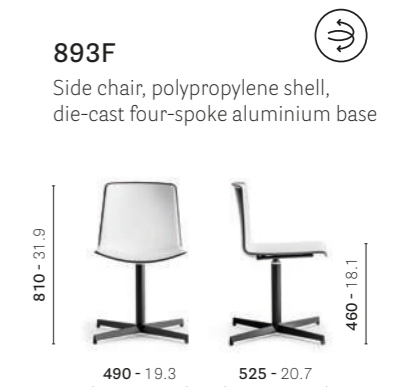
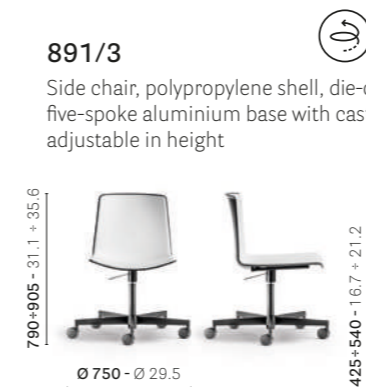
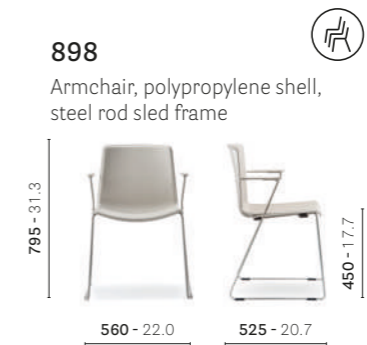
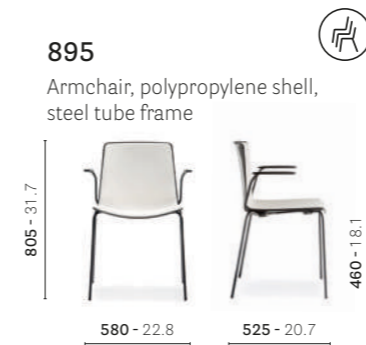
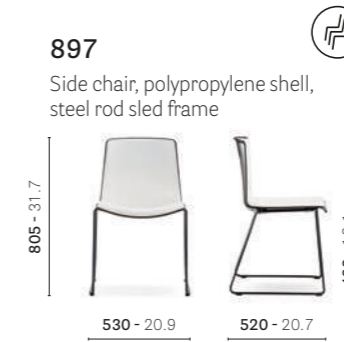

890/2
Side chair, upholstered shell,
steel tube frame



897/2
Side chair, upholstered shell,
steel rod sled frame



895/2
Armchair, upholstered shell,
steel tube frame



898/2
Armchair, upholstered shell,
steel rod sled frame



891/4
Side chair, upholstered shell, die-cast
five-spoke aluminium base with castors,
adjustable in height



893/2
Side chair, upholstered shell, die-cast
four-spoke aluminium base with castors



893F/2
Side chair, upholstered shell,
four-spoke die-cast aluminium base



892/2
Barstool, upholstered shell,
steel tube frame



896/2
Barstool, upholstered shell,
steel tube frame



899/2
Barstool, upholstered shell,
steel rod sled frame



894
Side chair, polypropylene shell, steel rod
sled frame, optional tablet arrangement



894/2
Side chair, upholstered shell, steel rod
sled frame, optional tablet arrangement



894/TT
Optional tablet



FINISHES / FINITURE

polypropylene / polipropilene

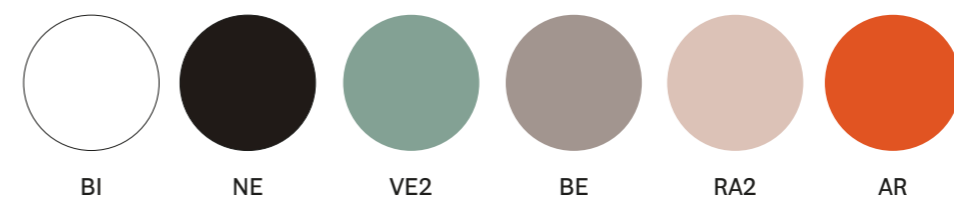

White front side always / scocca interna sempre bianca

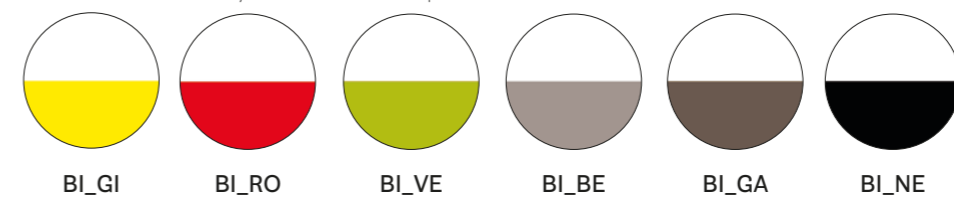

fabrics / tessuti

→ see booklet for finishes
vedi catalogo finiture

steel / acciaio

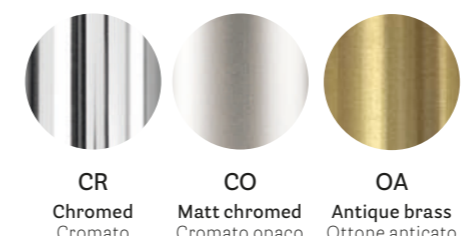

CR
Chromed
Cromato

CO
Matt chromed
Cromato opaco

OA
Antique brass
Ottone anticato

gold lacquered / laccato oro



VOR

powder coated / verniciato

→ see booklet for finishes
vedi catalogo finiture

CERTIFICATES / CERTIFICAZIONI

Safety, strength and durability tests / Prove di sicurezza, resistenza e durata
EN 1728:2012+AC2013 — EN 16139:2013 level 2



For
890 - 897 - 893 - 891/3
895 - 898 - 892 - 896 - 899

Buddy

Friendly spirit

DESIGN

Busetti Garuti Redaelli, 2017

EN — The Buddy collection made up of contemporary and versatile elements, is featured by a contrast between the bold volumes of the seat and a slender lightweight frame. A family of comfortable seating, poufs in different sizes with or without backrest and a sofa, that reflect their friendly spirit.

IT — La collezione Buddy, composta da elementi contemporanei e versatili nella loro semplicità, è caratterizzata da un contrasto tra i volumi pieni della seduta e la leggerezza dell'esile telaio. Una famiglia di sedute confortevoli, pouf in diverse dimensioni con o senza schienali e un divano, che si distinguono per il loro carattere amichevole.



WAITING

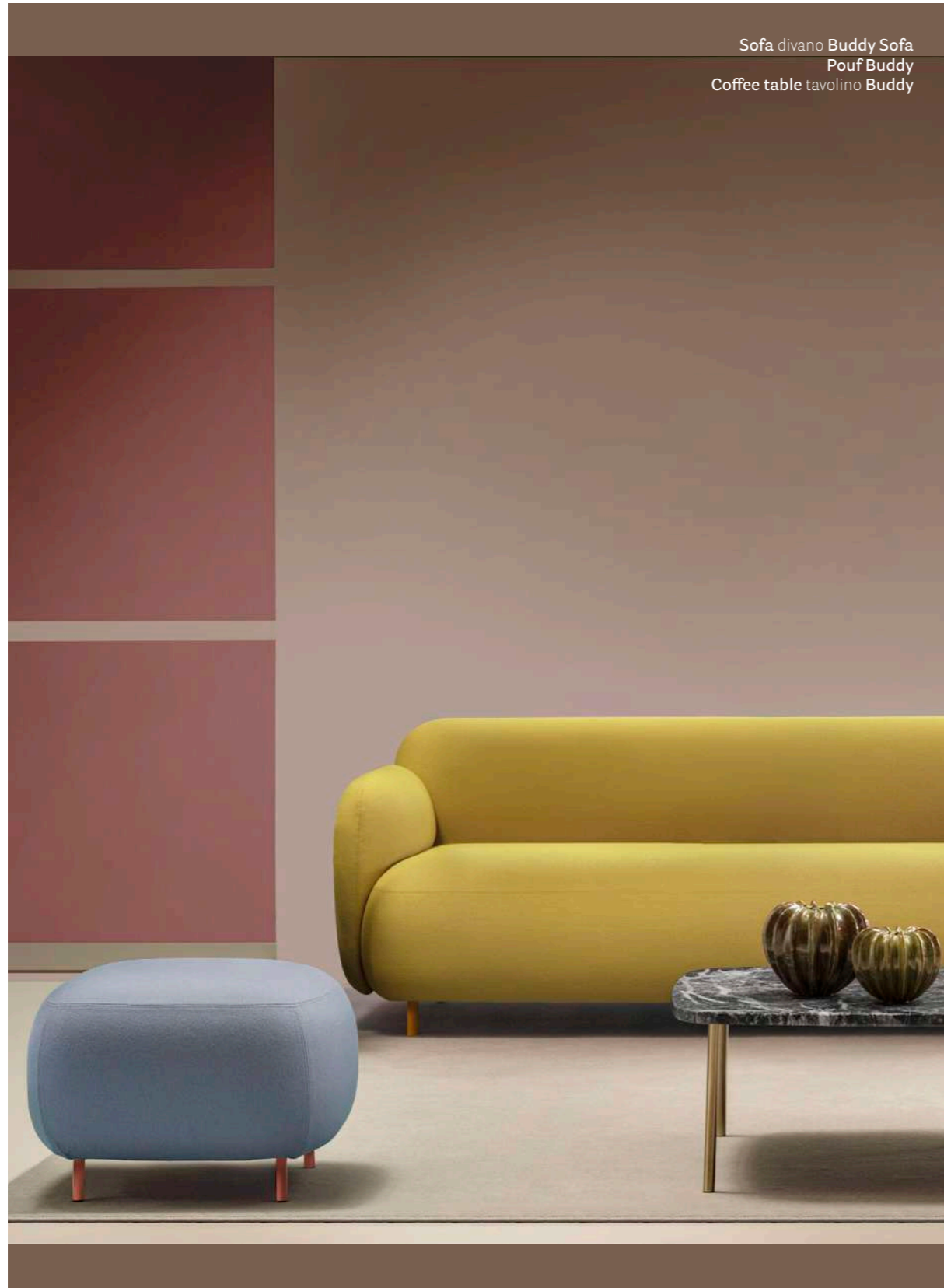

Sofa divano Buddy Sofa
Pouf Buddy
Coffee table tavolino Buddy

WORKSPACE



Sofa divano Buddhub
Pouf Buddy
Table tavolo Stylus

Pouf



Pouf with backrest
Pouf con schienale



Sofa

Divano



Campus Audencia Bachelors

Nantes, France

Project: University

Architect: IDM Design

Products: Buddy pouf with backrest and sofa

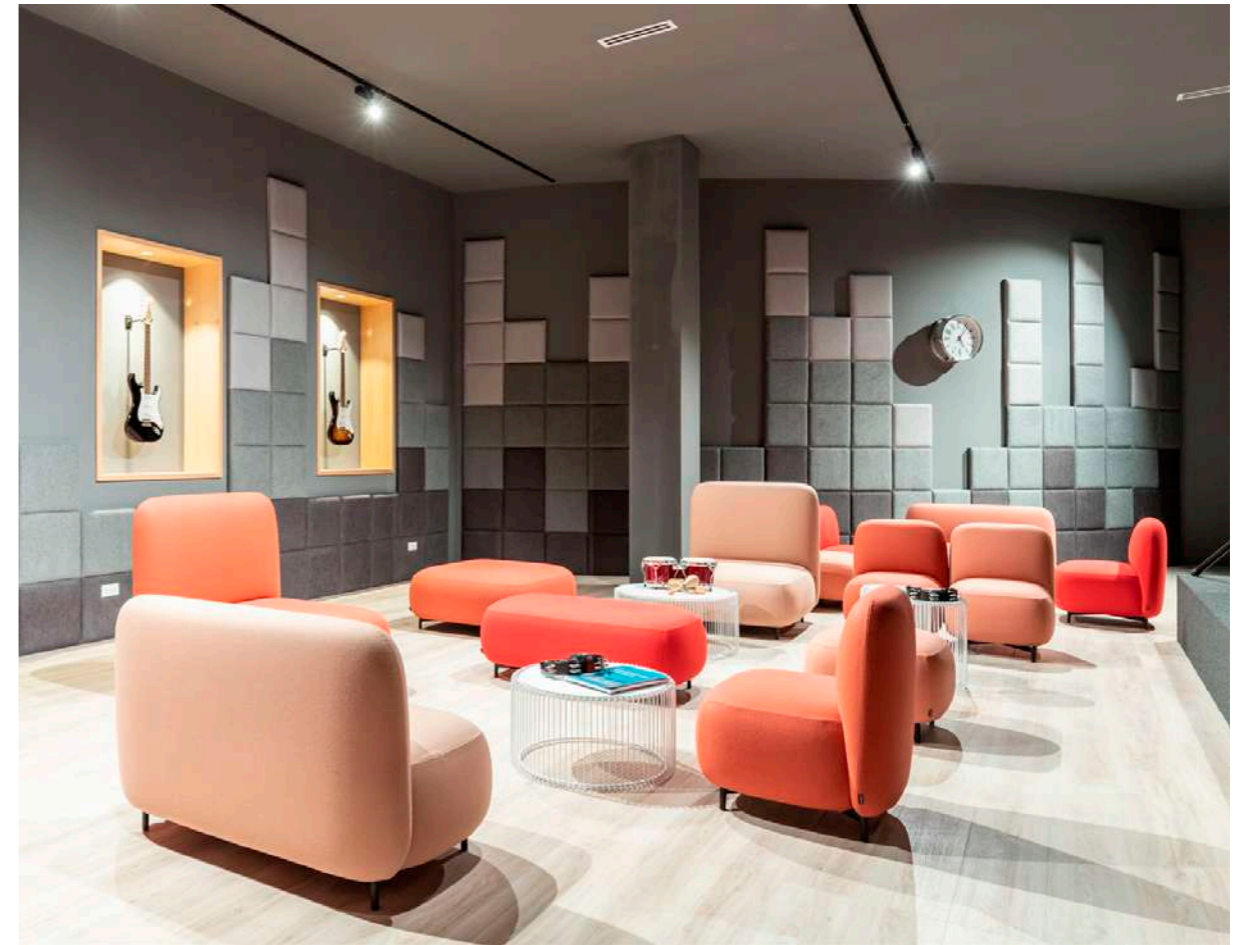
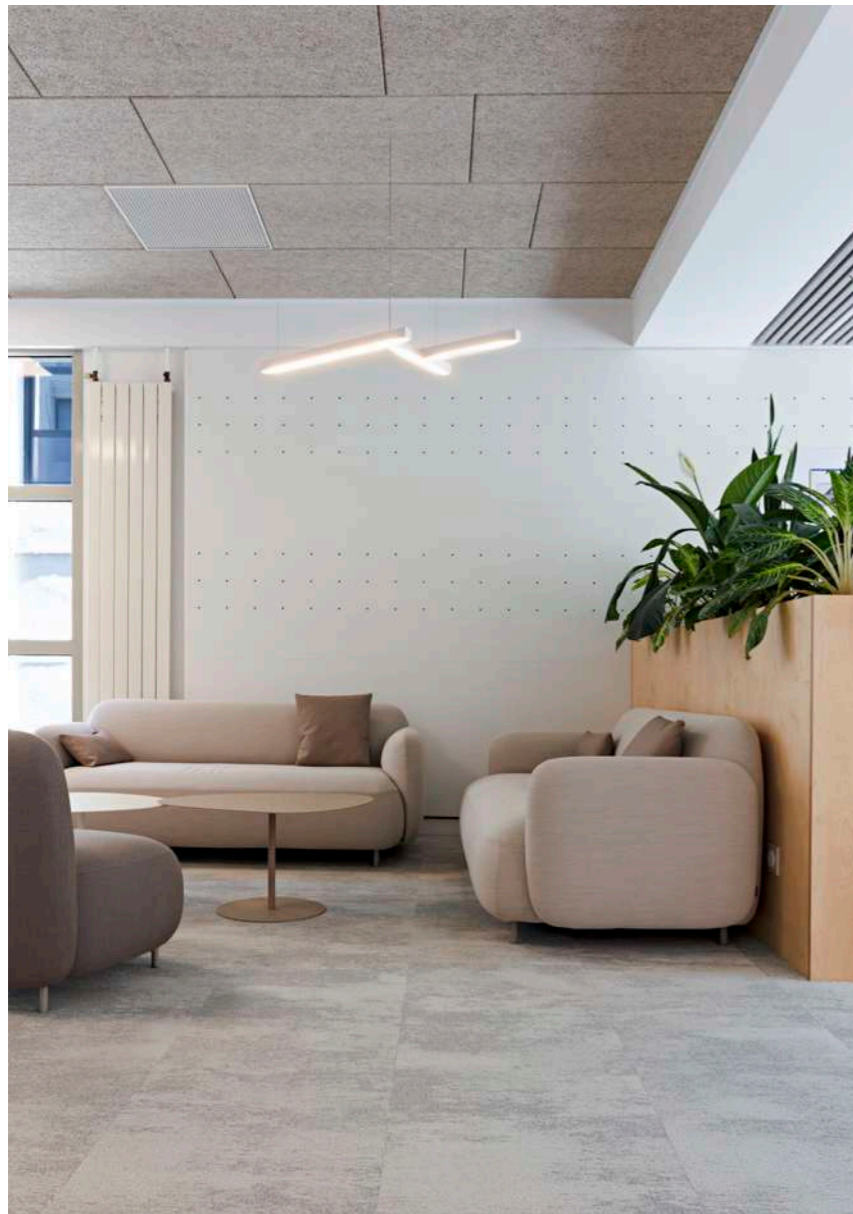

Aquarela Tower

Quito, Ecuador

Project: Office

Architect: Jean Nouvel Ateliers

Products: Buddy pouf
and pouf with backrest

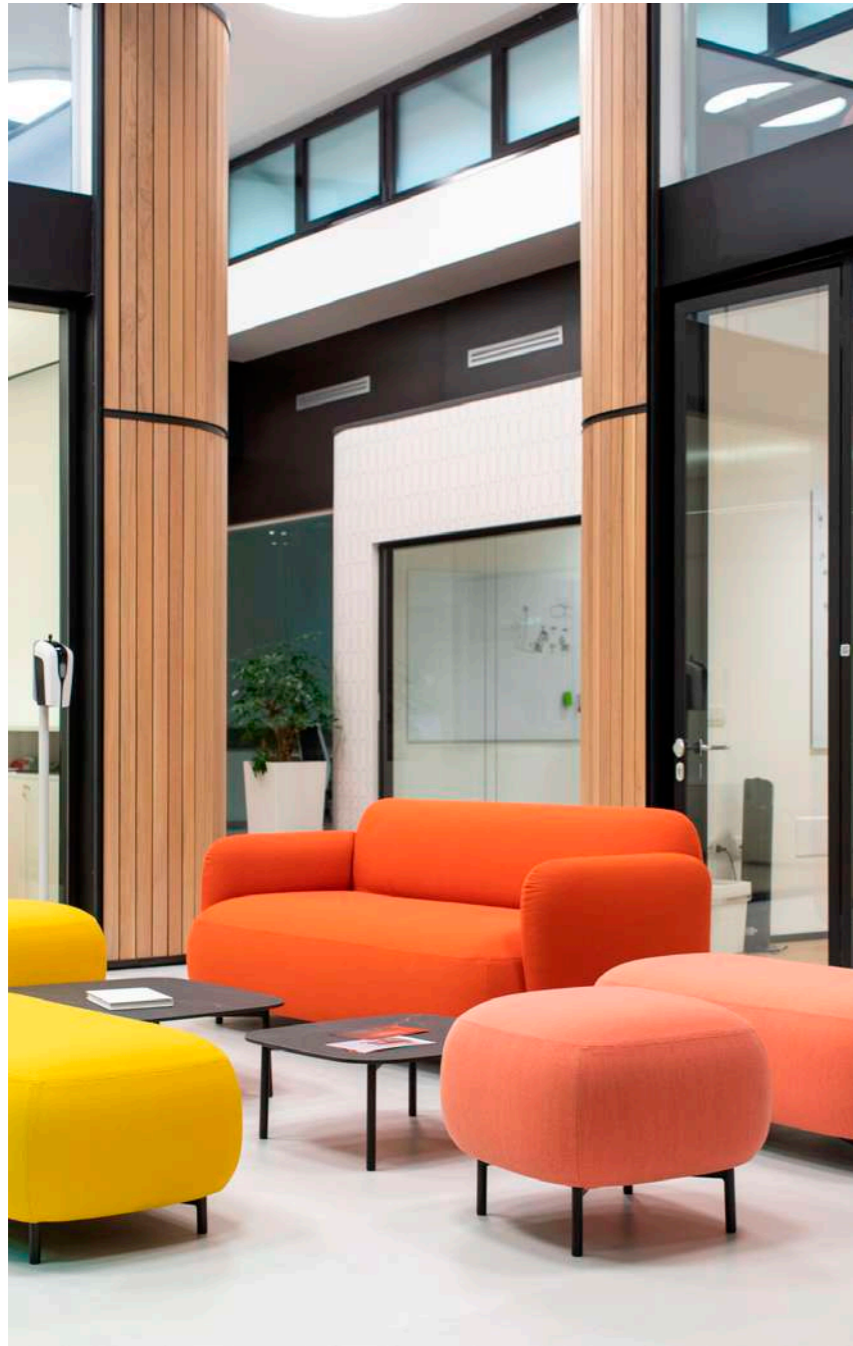

MUG - Magazzini Generativi

Bologna, Italy

Project: Co-working spaces

Architect: Sebastiano Longaretti, Mattia Sullini and Andrea Cattabriga

Products: Buddy pouf, sofa and coffee table



Shiseido Emea Office

Paris, France

Project: Office

Architect: Les Bâtisseurs Paris

Products: Buddy pouf, pouf with backrest and coffee table

210
Upholstered pouf,
steel tube frame



211
Upholstered pouf,
steel tube frame



212
Upholstered pouf,
steel tube frame



213
Upholstered pouf,
steel tube frame



214
Upholstered pouf, steel tube frame



215
Upholstered pouf, steel tube frame



210S
Upholstered chair, steel tube frame



211S
Upholstered chair, steel tube frame



212S
Upholstered chaise-longue, steel tube frame



213S
Upholstered chaise-longue, steel tube frame



214S
Two-seats upholstered sofa, steel tube frame



215S
Two-seats upholstered sofa, steel tube frame



218
Upholstered two-seats sofa, aluminium legs, version without armrest available (item 218/2)



219
Upholstered three-seats sofa, aluminium legs, version without armrest available (item 219/2)



215S/TT
Turning tablet



212S.3
Cushion only



SIZES / DIMENSIONI

mm - in



BDT_59X59X26

Coffee table, steel tube legs, marble / solid laminate* top



590x590 - 23.2x23.2

BDT_59X59X32

Coffee table, steel tube legs, marble / solid laminate* top



590x590 - 23.2x23.2

BDT_79X79X26

Coffee table, steel tube legs, marble / solid laminate* top



790x790 - 31.1x31.1

BDT_79X79X32

Coffee table, steel tube legs, marble / solid laminate* top



790x790 - 31.1x31.1

* Table height decreases of 10 mm for solid laminate top versions
L'altezza del tavolo si riduce di 10 mm per le versioni con ripiano in stratificato

For Buddy coffee tables see finishes in Tables catalogue

BDT_120X59X26

Coffee table, extruded aluminium legs, solid laminate top



1200 - 47.2

590 - 23.2

BDT_120X59X32

Coffee table, extruded aluminium legs, solid laminate top



1200 - 47.2

590 - 23.2

BDT_79X40X26

Coffee table, extruded aluminium legs, solid laminate top



790 - 31.1

400 - 15.7

BDT_79X40X32

Coffee table, extruded aluminium legs, solid laminate top



790 - 31.1

400 - 15.7

BDTD_79X26

Coffee table, extruded aluminium legs, solid laminate top



Ø790 - Ø31.1

BDTD_79X32

Coffee table, extruded aluminium legs, solid laminate top



Ø790 - Ø31.1

SEATING FINISHES / FINITURE SEDUTE

steel / acciaio



OA
Antique brass
Ottone anticato

NERO

aluminium / alluminio



OA
Antique brass
Ottone anticato

NERO

powder coated / verniciato



→ see booklet for finishes
vedi catalogo finiture

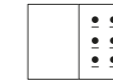

fabrics / tessuti



→ see booklet for finishes
vedi catalogo finiture

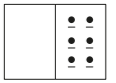

CERTIFICATES / CERTIFICAZIONI

Safety, strength and durability tests / Prove di sicurezza, resistenza e durata
EN 1728:2012+AC2013 — EN 16139:2013 level 2

Omologation "Class 1IM"
Omologazione "Classe 1IM"

TABLE FINISHES / FINITURE TAVOLI

powder coated / verniciato



→ see booklet for finishes
vedi catalogo finiture

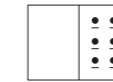

tops / ripiani



→ see catalogue Tables 02
vedi catalogo Tavoli 02

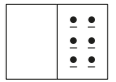

Buddy Oasi

Friendly spirit

DESIGN

Busetti, Garuti, Redaelli, 2024

EN — Buddy Oasi is a system of soft seatings that further expands the Buddy collection. Generously sized ottomans and sofas that maintain the contrast between the bold volumes of the seat and the lightness of the aluminium legs. The distinguishing feature of Buddy Oasi is its movable backrest, featuring a soft, organic shape. Made of injected polyurethane foam, it can be easily and freely positioned on the seat to create multiple configurations. Buddy Oasi is designed to furnish both indoor and outdoor areas.

IT — Buddy Oasi è la soluzione d'arredo che amplia ulteriormente la collezione di imbottiti Buddy. Un sistema di pouf e divani dalle generose dimensioni, che mantengono il contrasto tra i volumi pieni della seduta e la leggerezza dell'esile telaio in alluminio tipico della famiglia Buddy. Il tratto distintivo di Buddy Oasi sono gli schienali mobili in schiumato poliuretano dalla forma morbida e allungata che possono essere posizionati facilmente e liberamente sul pouf, permettendo di creare diverse configurazioni in base alle diverse esigenze. Buddy Oasi è pensato per arredare sia ambienti indoor che outdoor.





Sofa divano Buddy Oasi
Coffee table tavolino Caementum
Lighting lampada Giravolta

WAITING

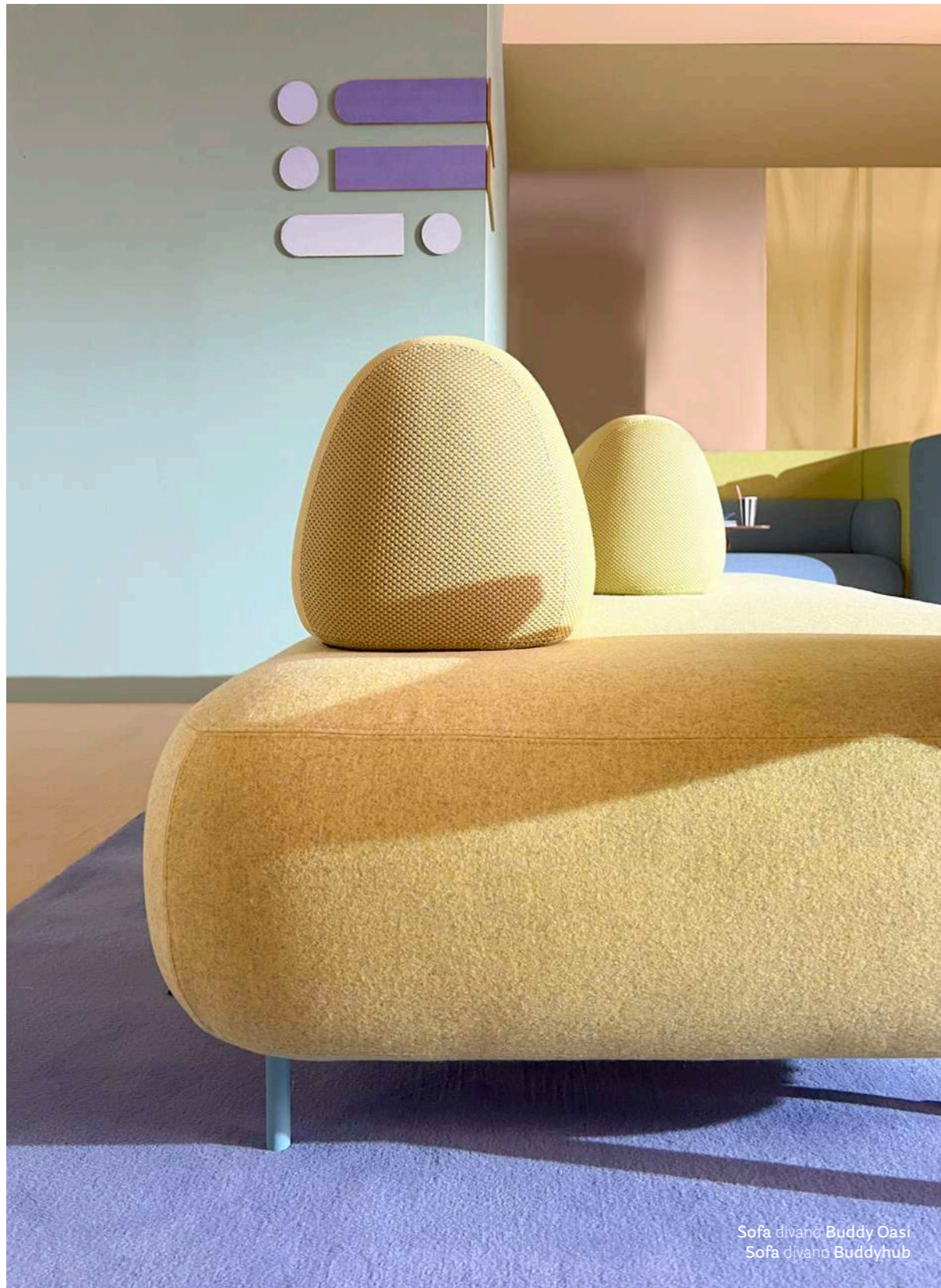

Sofa divano Buddy Oasi
Sofa divano Buddyhub

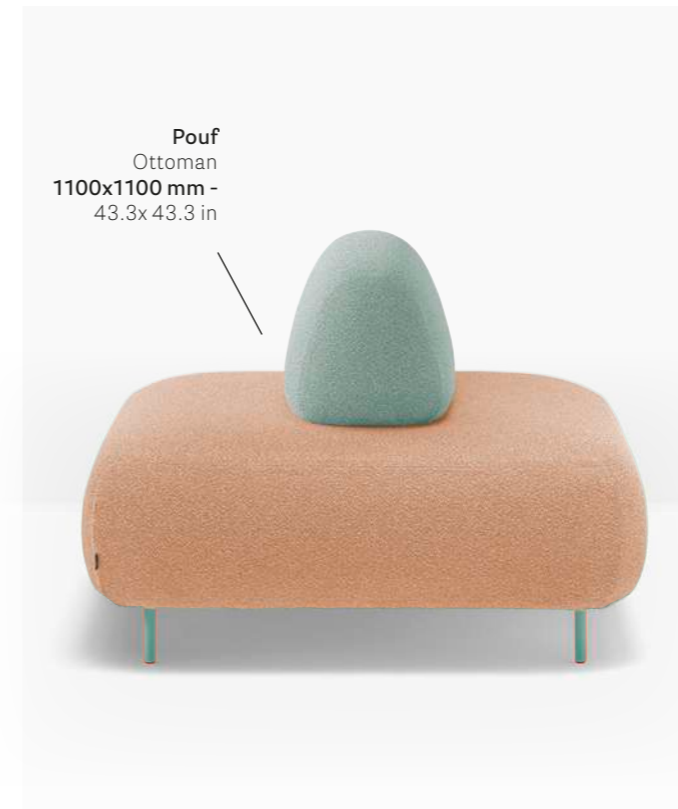

Pouf
Ottoman
1100x1100 mm -
43.3x 43.3 in

Sofa Divano

Powder coated aluminium legs
Gambe in alluminio verniciato
h 450 mm - 17.7 in



207 + 209.3



A ballast and a non-slip fabric give the backrests stability
 La zavorra e il tessuto antiscivolo conferiscono agli schienali stabilità



209 + 209.3

Height-adjustable
 Diego side table
 Tavolino Diego
 regolabile in altezza



5910



#pedralitales

Noto, Sicily

Project: 2024 ADV campaign

Products: Buddy Oasi sofa,
Buddy pouf, Caementum coffee table

CIID Astino

Bergamo, Italy

Project: Educational

Products: Buddy Oasi sofa,
Nolita barstool, Elliot poseur table

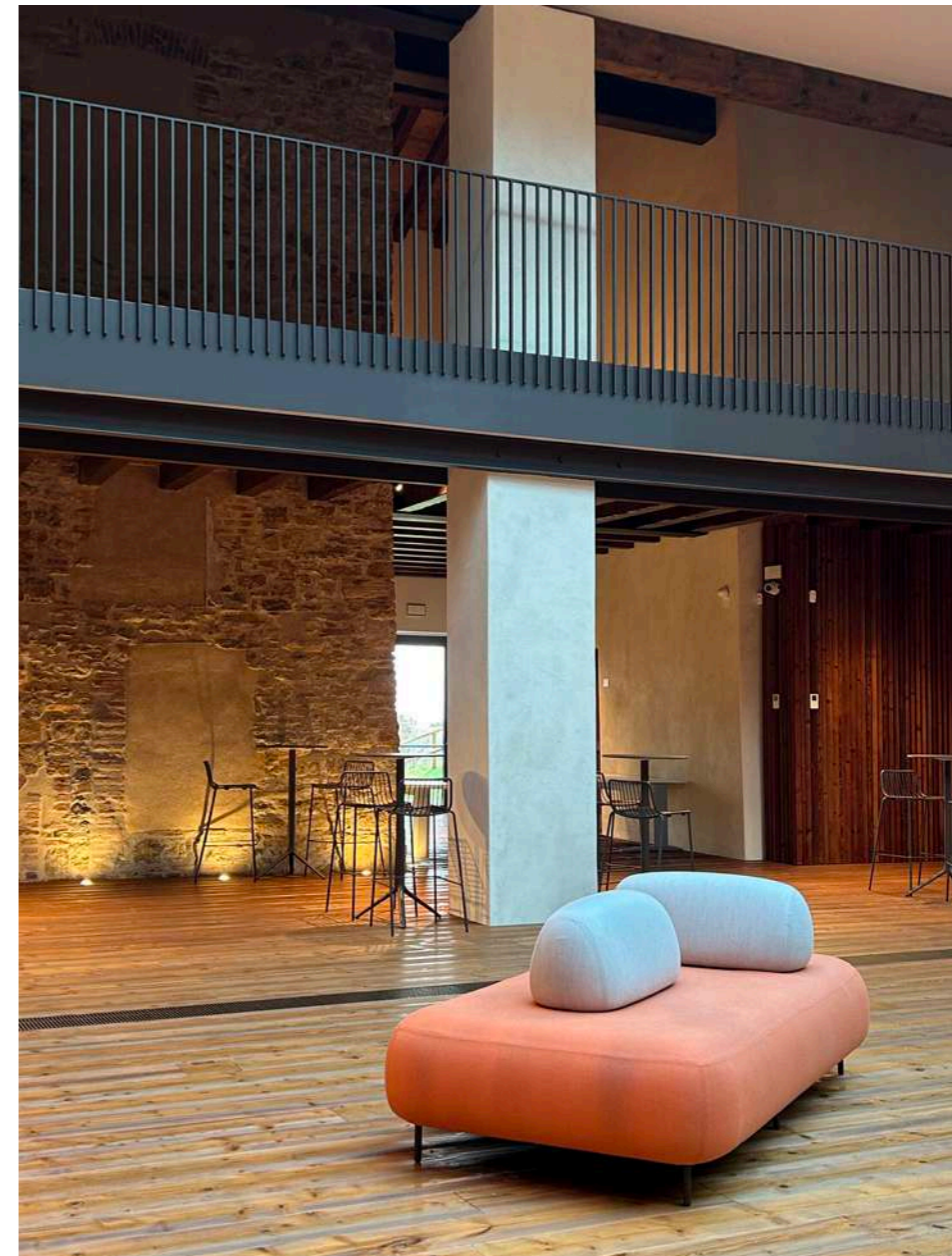

#PedraliColoursofLightness

Salone Del Mobile.Milano 2024
Milan, Italy

Project: Exhibition stand

Architect and styling: DWA Design Studio

Products: Buddy Oasi sofa, Buddy pouf, Caementum coffee table

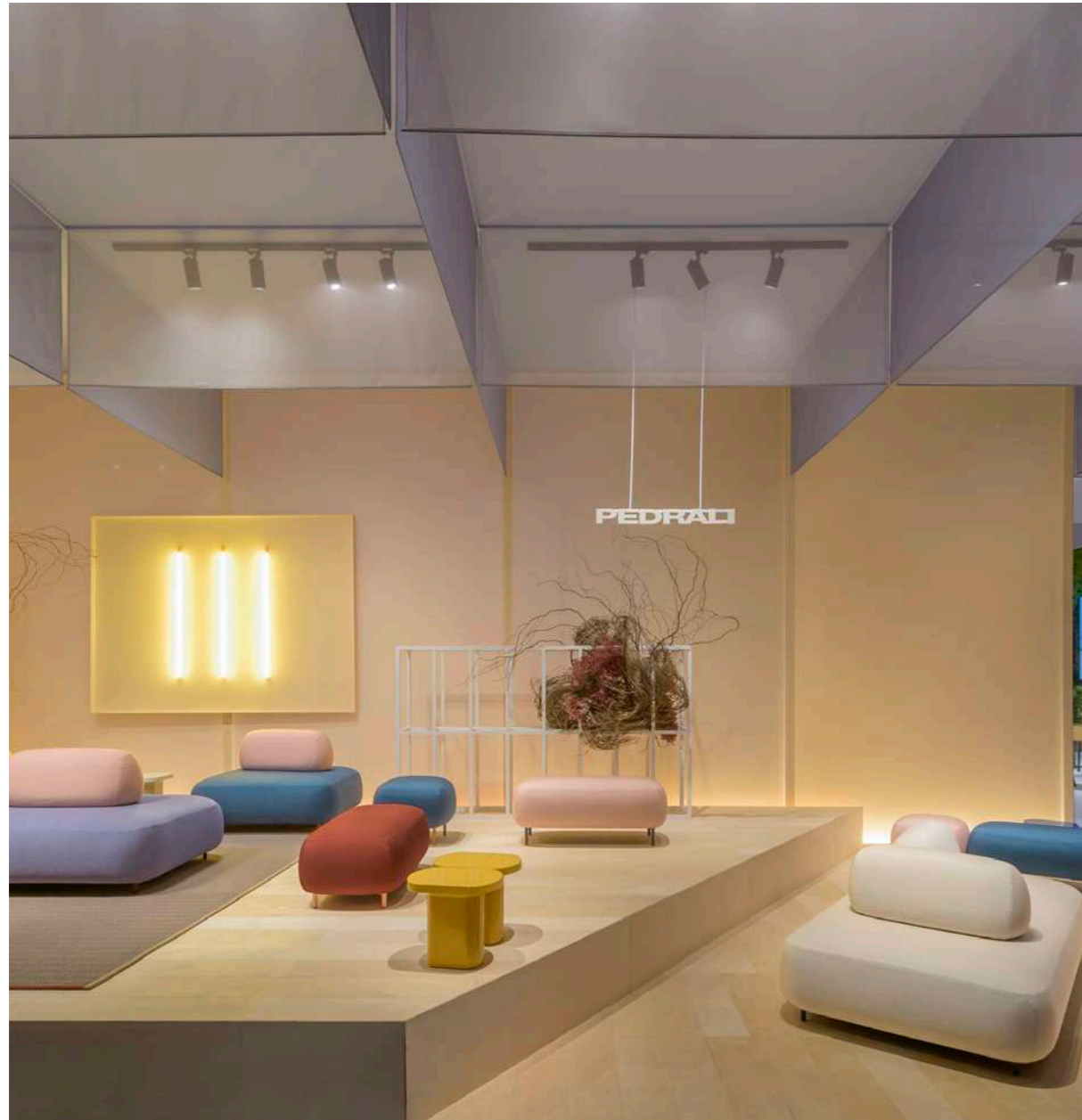

SIZES / DIMENSIONI

mm - in

206

Upholstered pouf,
steel tube frame



207

Upholstered pouf,
steel tube frame



208

Upholstered sofa,
steel tube frame

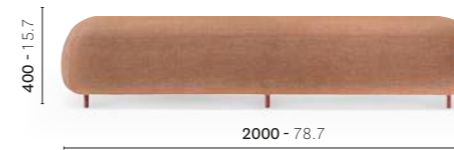

209

Upholstered sofa,
steel tube frame

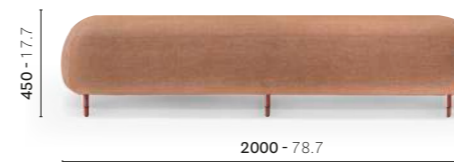

209.3

Upholstered backrest,
steel tube frame



FINISHES / FINITURE



fabrics / tessuti

→ see booklet for finishes
vedi catalogo finiture

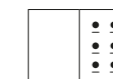

powder coated / verniciato

→ see booklet for finishes
vedi catalogo finiture

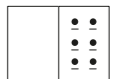

Buddyhub

Friendly spirit

DESIGN
Busetti Garuti Redaelli, 2020

EN — Buddyhub is characterized by a wrap-around, sound absorbing panel which envelops the seat in a sort of enclosed niche. Available as an armchair or sofa, it can be used as a temporary sound-proofed workstation. It is also possible to place two units opposite each other and to join them by means of a panel to which a table can be attached, thus creating an informal meeting space or break area. A large seat, in polyurethane foam supported by elastic belts, and a cosy backrest offer exceptional comfort.

IT — Buddyhub è caratterizzato da un pannello fonoassorbente perimetrale che abbraccia l'imbottito creando una sorta di rifugio dall'ambiente circostante. Disponibile nella versione poltrona o divanetto, si configura come postazione di lavoro temporanea. Ponendo i due elementi uno di fronte all'altro, uniti tra loro da un pannello a cui può essere fissato un tavolino, danno vita a spazi pensati per ospitare meeting informali e aree break-out. La dimensione generosa della seduta, realizzata in schiumato poliuretano con cinghie elastiche, e l'accogliente schienale consentono un alto grado di comfort.



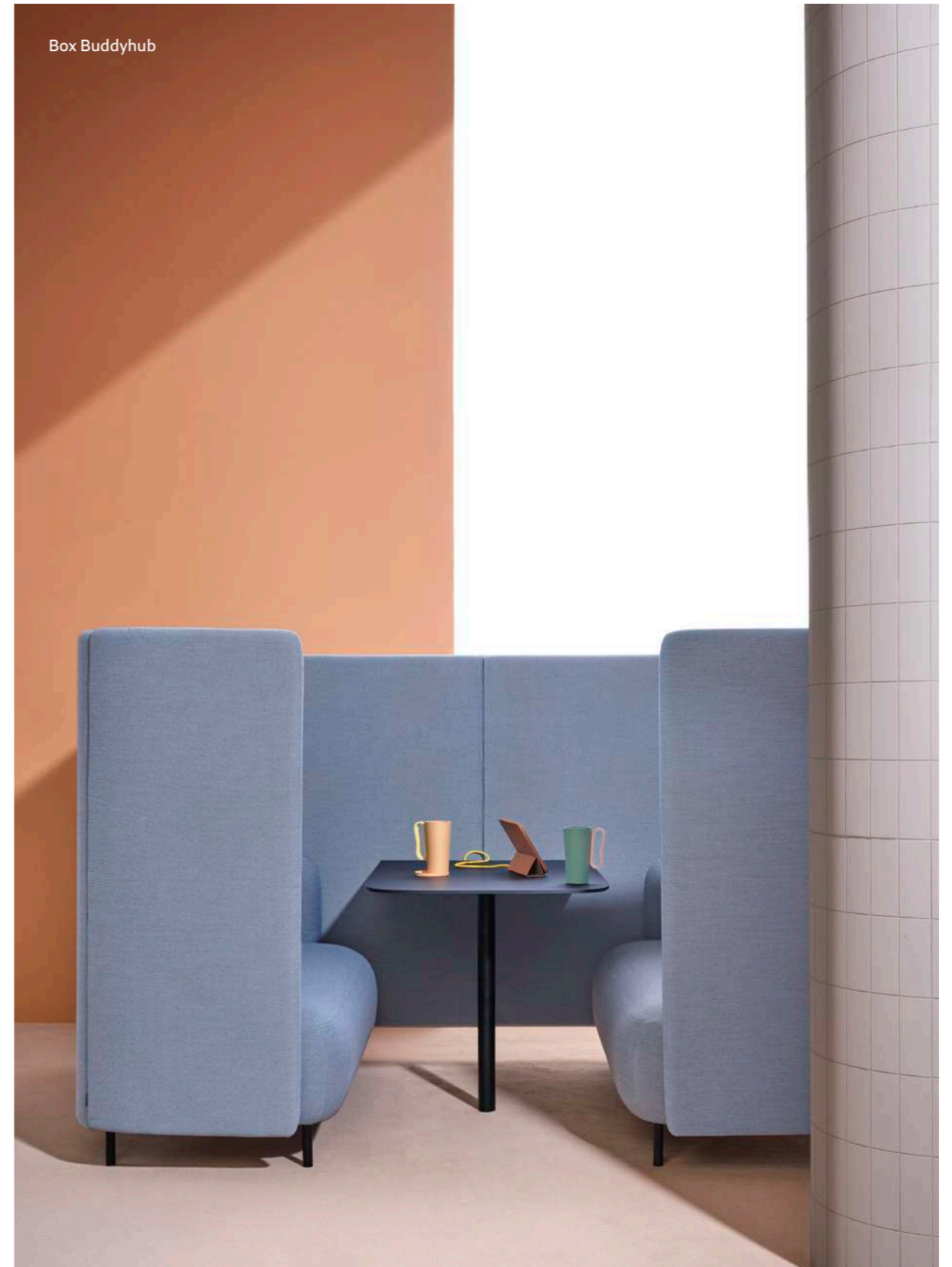

Armchair poltrona Buddyhub
Turning tablet tavoletta girevole
USB socket presa USB



Armchair Poltrona



Backrest height
Altezza schienale
1400 mm - 55.1 in



BDH001/140

Buddyhub and buddyhub desk combined
to create collaborative and meeting areas
Buddyhub e buddyhub desk affiancati per creare
aree co-working e meeting



BDH001T/140 + BDS002/140_CCO



Sofa

Divano



Box

Four-seater box with the possibility of adding sockets and optional screen
Box a quattro posti con predisposizione all'elettrificazione e schermo opzionale



BDH022M/140

Four-seater box with the possibility of adding sockets and optional shelf
Box a quattro posti con predisposizione all'elettrificazione e mensola opzionale



Four-seater box with optional table
Box a quattro posti con tavolo a penisola opzionale



BDH022P/140

Mind the value

Milan, Italy

Project: Office

Architect: Atelierzero

Products: Buddyhub armchair,
Buddy pouf with backrest and sofa

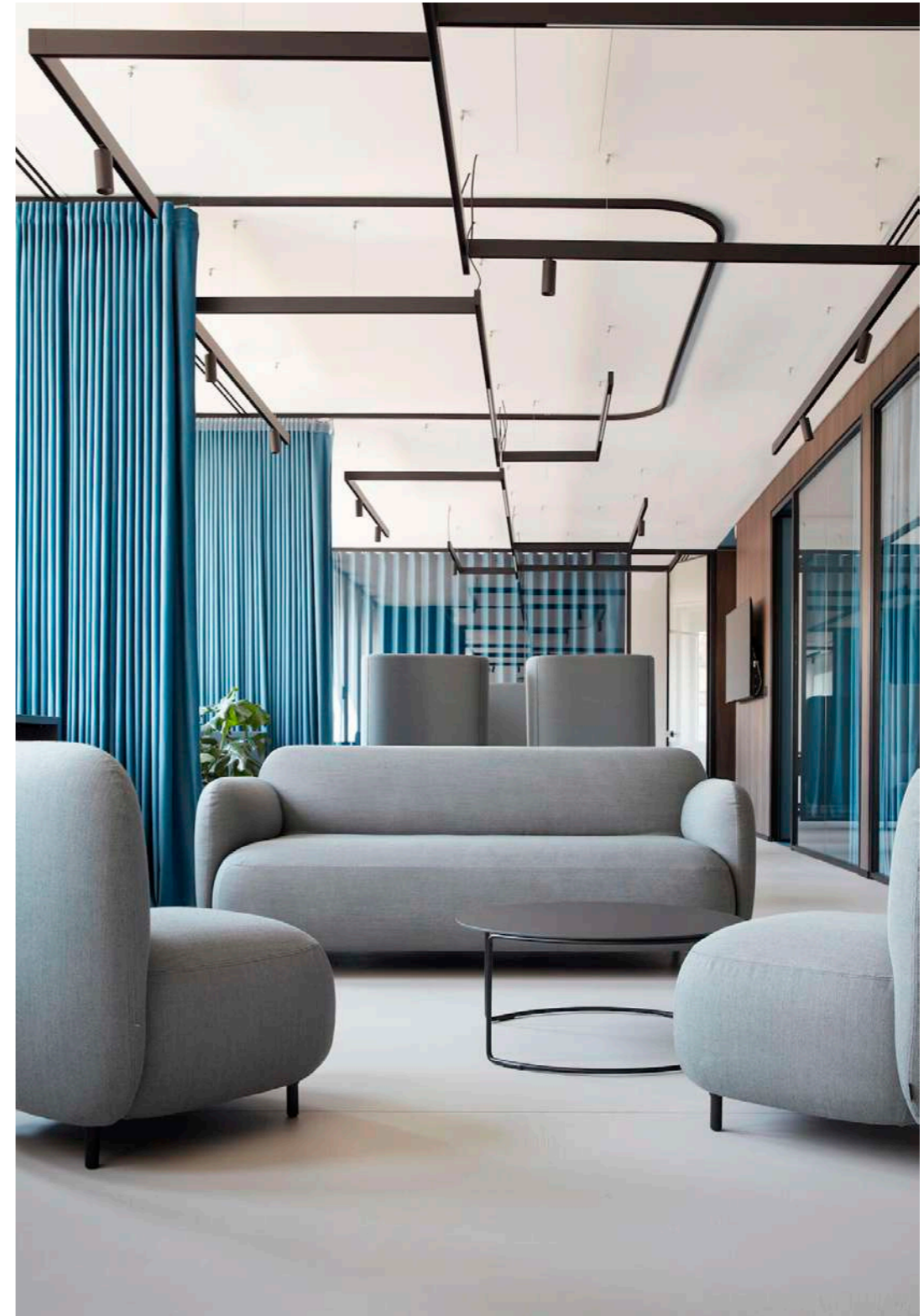

MGA Offices

Cerdanyola del Vallès, Spain

Project: Office

Products: Buddyhub armchair, Buddy pouf with backrest



Pedrali Collaborative Space

Bergamo, Italy

Project: Headquarters

Architect: Park Associati

Products: Buddyhub sofa and box, Toa table, Nemea side chair

BDH001/100

Upholstered armchair, low backrest, steel tube frame



BDH001/140

Upholstered armchair, high backrest, steel tube frame



BDH001/140_USB

Upholstered armchair, high backrest, steel tube frame, with USB socket



BDH001T/140

Upholstered armchair, high backrest, steel tube frame, with turning tablet
TABLET: 370X300 - 14.6X11.8



BDH001T/140_USB

Upholstered armchair, high backrest, steel tube frame, with turning tablet and USB socket



BDH002/100

Two-seats upholstered sofa, low backrest, steel tube frame



BDH002/140

Two-seats upholstered sofa, high backrest, steel tube frame



BDH011/140

Two-seats upholstered box, steel tube frame



BDH011M/140

Two-seats upholstered box, steel tube frame, with shelf
SHELF: 600X120 - 23.6X4.7



BDH011P/140

Two-seats upholstered box, steel tube frame, with table
TABLE: 690X500 - 27.2X19.7



BDH011P/140_CCO

Two-seats upholstered box, steel tube frame,
with table equipped with socket
TABLE: 690X500 - 27.2X19.7



BDH022/140

four-seats upholstered box, steel tube frame



BDH022M/140

Four-seats upholstered box, steel tube frame, with shelf
SHELF: 600X120 - 23.6X4.7



BDH022P/140

Four-seats upholstered box, steel tube frame, with table
TABLE: 690X500 - 27.2X19.7



BDH022P/140_CCO

Four-seats upholstered box, steel tube frame,
with table equipped with socket
TABLE: 690X500 - 27.2X19.7



FINISHES / FINITURE

fabrics and powder coated / tessuti e verniciati

→ see booklet for finishes
vedi catalogo finiture

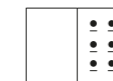

AWARDS / PREMI



CERTIFICATES / CERTIFICAZIONI

Safety, strength and durability tests /
Prove di sicurezza, resistenza e durata
EN 1728:2012+AC2013 — EN 16139:2013 level 2

EN ISO 354:2003 Reverberation rooms - Sound test
EN ISO 354:2003 Camera riverberante, test acustico

UNI EN ISO 11654:1997 Rating of sound absorption
UNI EN ISO 11654:1997 Valutazione dell'assorbimento acustico

IMQ CERTIFICATE / CERTIFICATO IMQ
Test report 0064\DC\ACU\21_2 /
Rapporto di prova 0064\DC\ACU\21_2

Buddyhub desk

Friendly spirit

DESIGN

Busetti Garuti Redaelli, 2022

EN — Buddyhub desk is a functional and efficient workstation where users can concentrate and isolate. It features a perimeter sound-absorbing panel that embraces a solid laminate top, creating a sort of enclosed niche that ensures acoustic and visual privacy. It can be used as a multifunctional or standing workstation designed for informal work needs or for calls, in both a standing or sitting position.

IT — Buddyhub desk è una postazione di lavoro funzionale ed efficiente, in cui potersi concentrare e isolare. È caratterizzato da un pannello fonoassorbente perimetrale che abbraccia un piano di lavoro in stratificato, creando una nicchia di privacy riservata e acusticamente protetta. Può configurarsi come una postazione operativa oppure come postazione temporanea, in cui lavorare in modo informale o dedicarsi a call, in piedi o da seduti.



Barstool sgabello Arki-Stool
Table tavolo Buddyhub Desk
Coat hanger gancio appendiabiti
Magazine holder portariviste

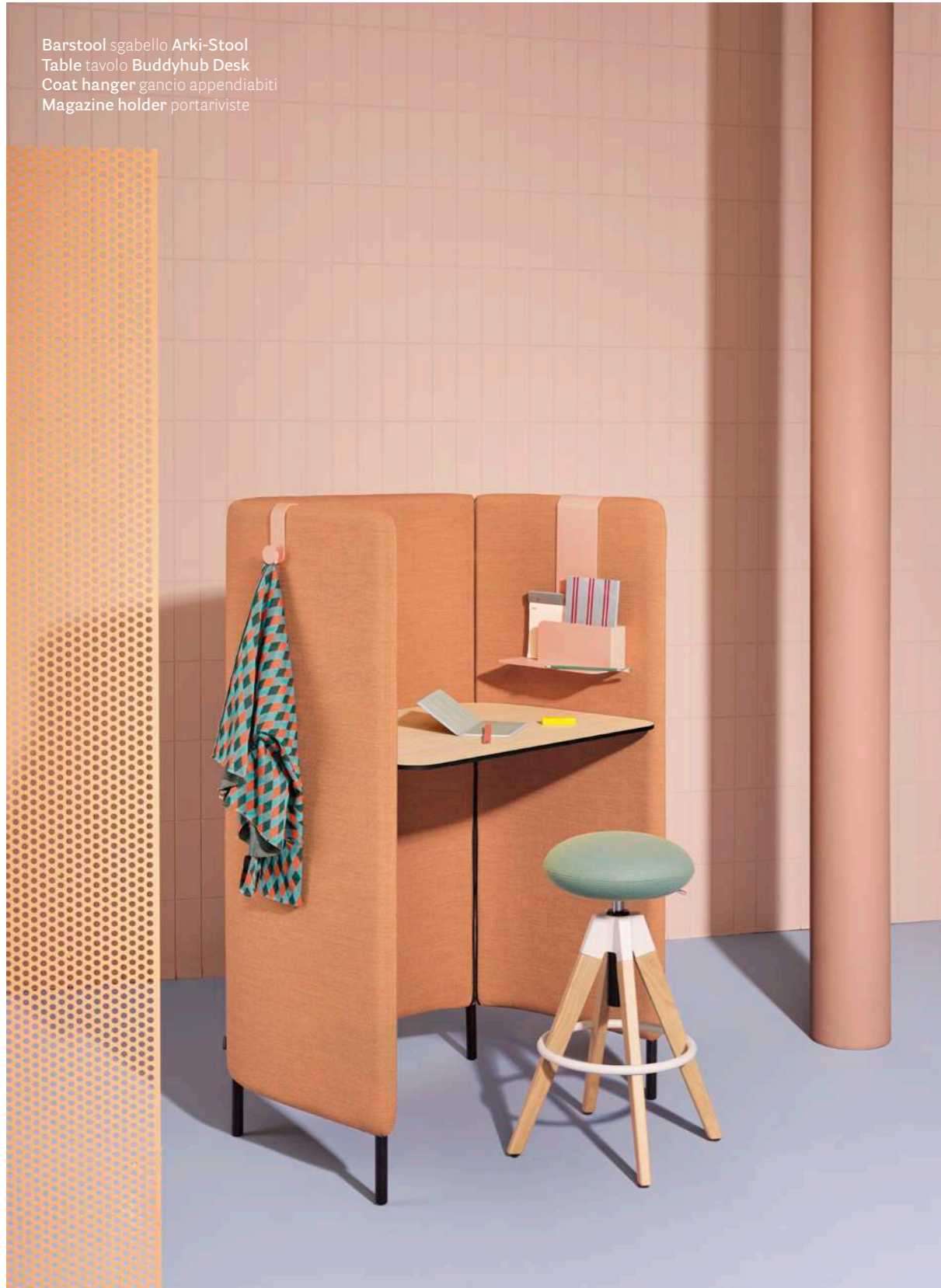

Barstool sgabello Arki-Stool
Table tavolo Buddyhub Desk
Magazine holder portariviste
Pop-up socket presa a scomparsa

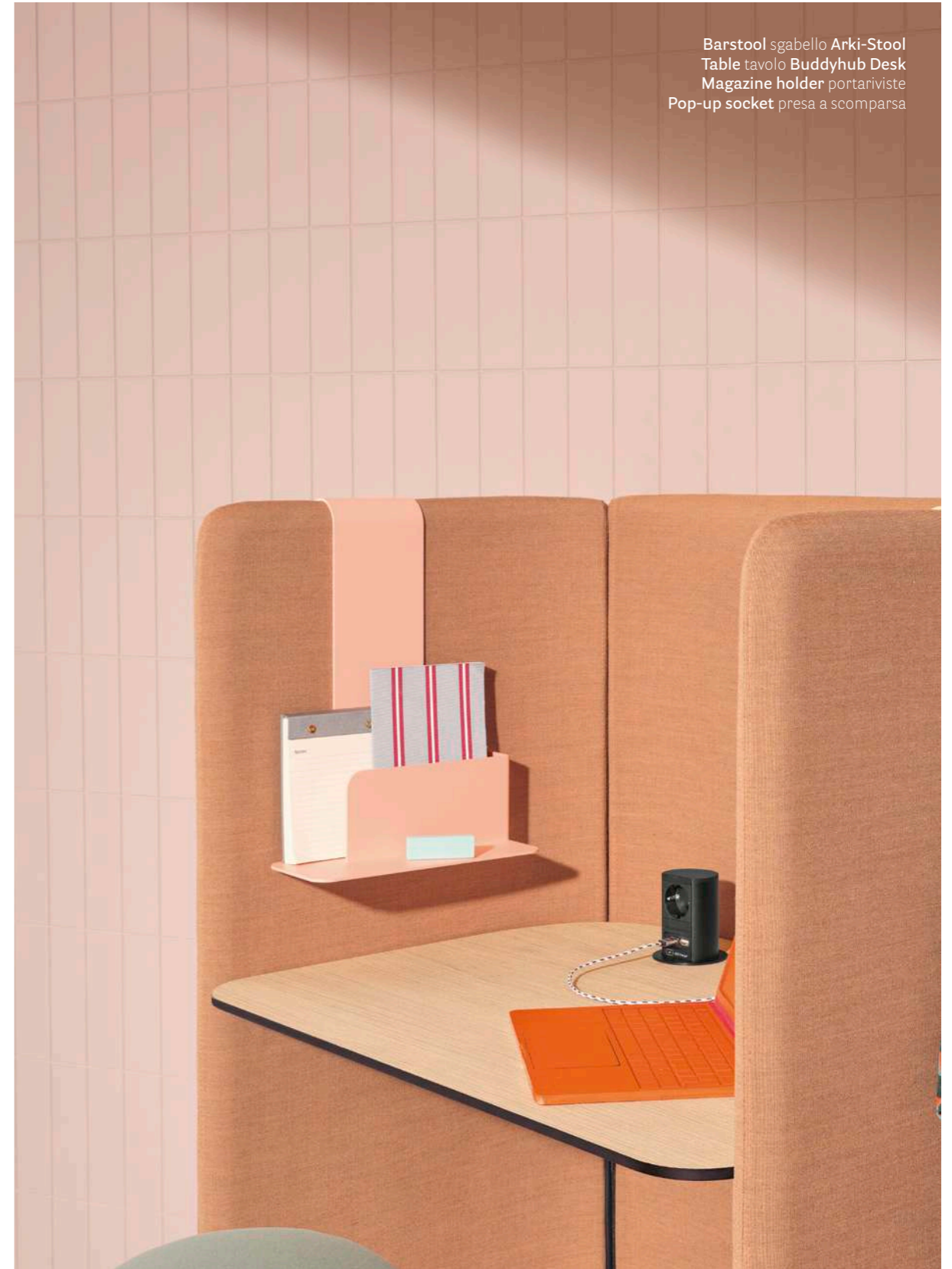

Table

Tavolo

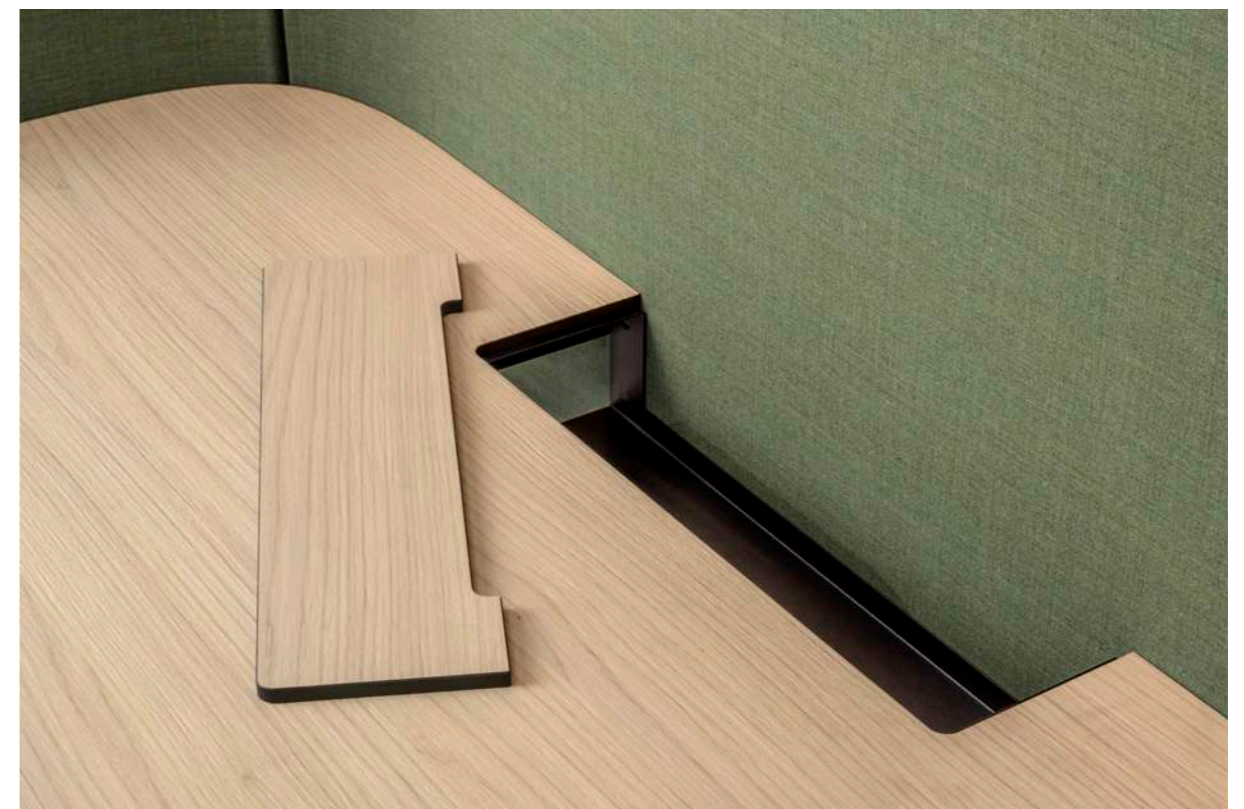
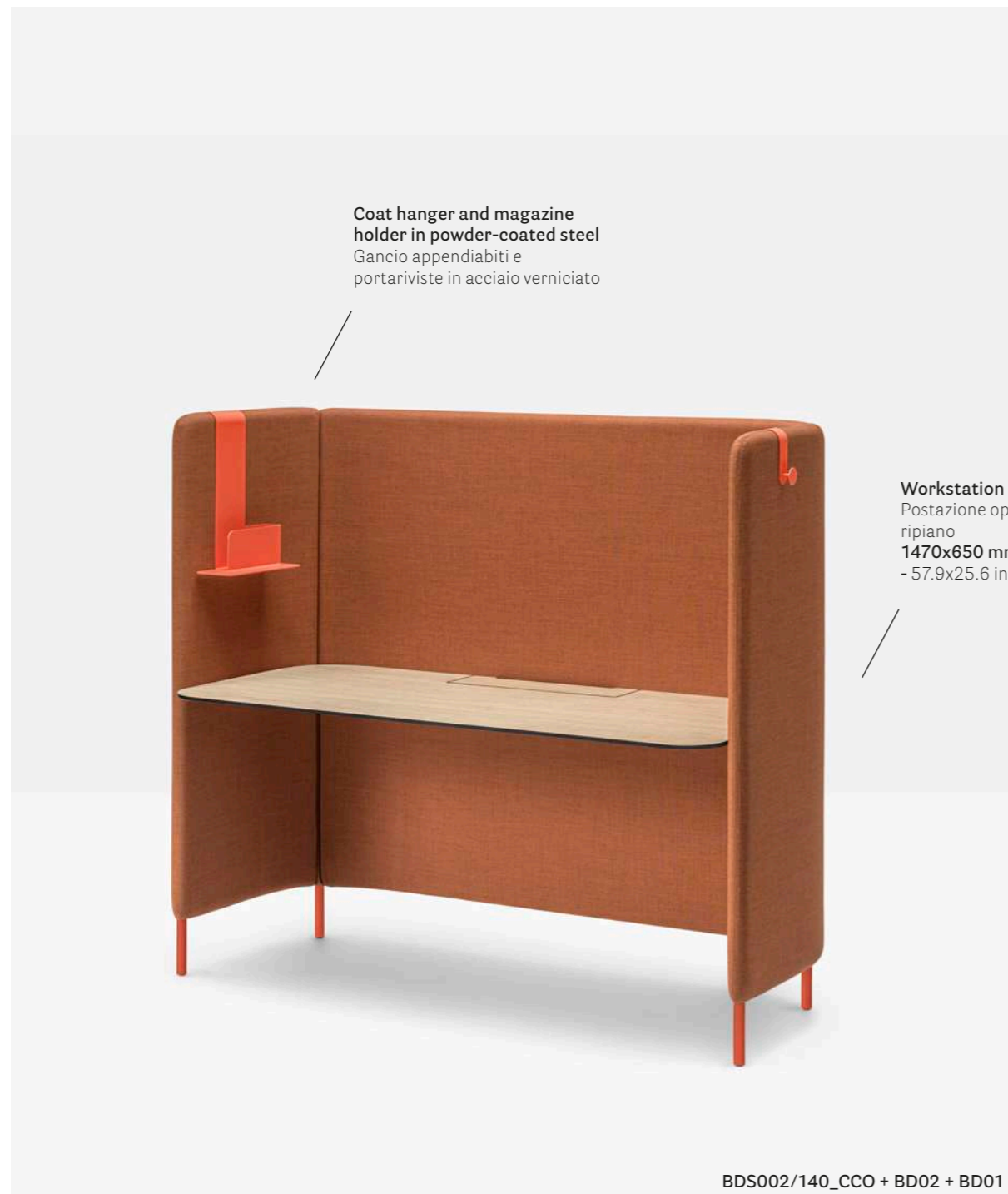





#PedraliWorkspaces

Orgatec 2022
Cologne, Germany

Project: Exhibition stand
Products: Buddyhub sofa and Buddyhub desk,
Nym Soft armchair, Arki-Stool barstool,
Hevea pot-holder



Workspaces Design Show

London, United Kingdom

Project: Exhibition stand

Products: Buddyhub sofa and
Buddyhub desk, Nym Soft armchair

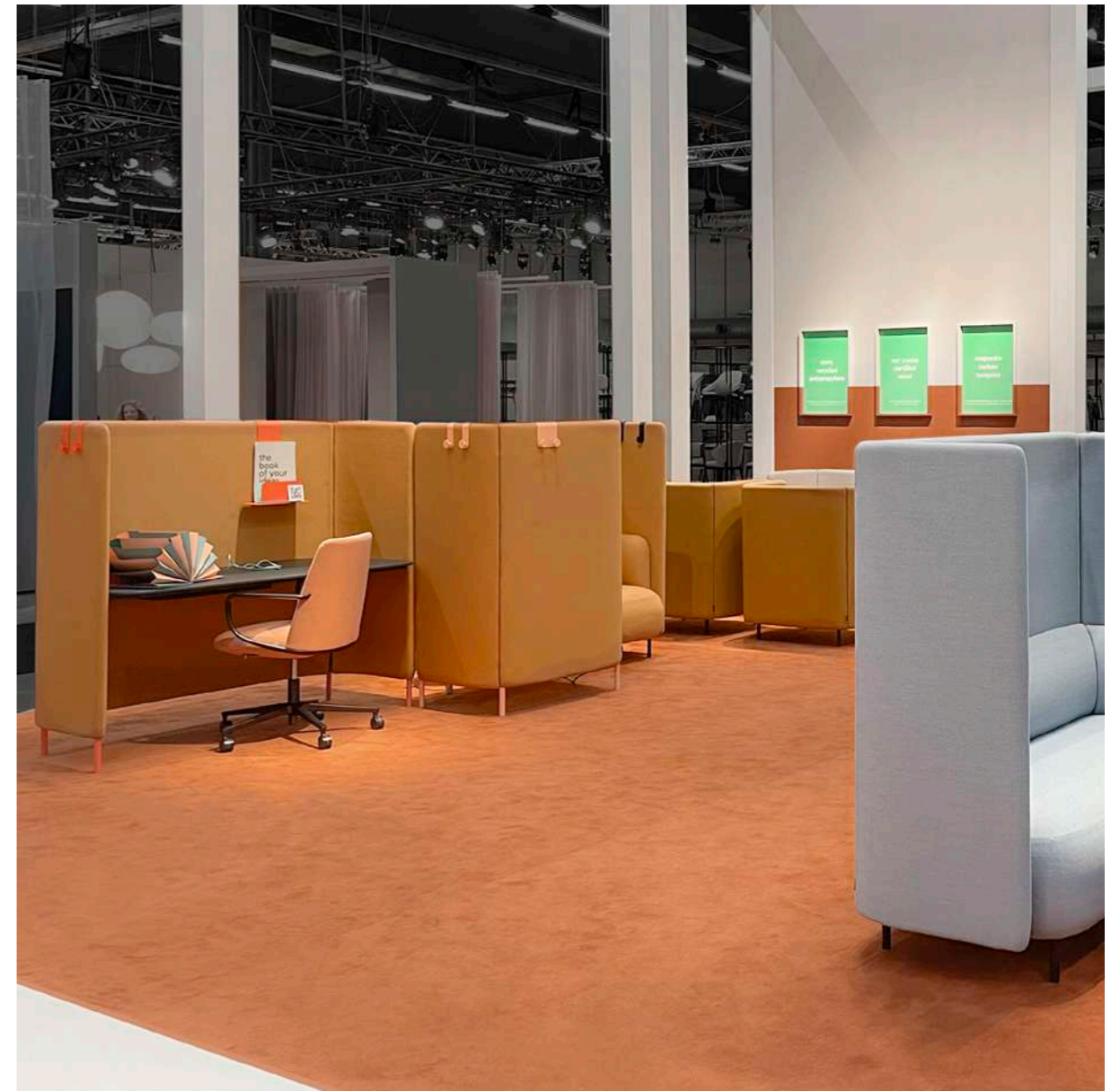

#PedraliNewOrizons

Stockholm Furniture & Light Fair, 2023
Stockholm, Sweden

Project: Exhibition stand

Architect: CalviBrambilla

Products: Buddyhub sofa and box,
Buddyhub desk, Elinor low back executive chair

SIZES / DIMENSIONI

mm - in

BDS001/140

Upholstered standing workstation, aluminum frame, Fenix® or solid laminate top



BDS001/140_FSX

Upholstered standing workstation, aluminum frame, Fenix® or solid laminate top, with cable management



BDS002/140

Upholstered workstation, aluminum frame, Fenix® or solid laminate top



BDS002/140_CCO

Upholstered workstation, aluminum frame, Fenix® or solid laminate top, with cable management



BD01

Coat hanger



BD02

Magazine holder



ME/00183

Pop-up socket only for BDS001/140_FSX



FINISHES / FINITURE

powder coated / verniciato

→ see booklet for finishes
vedi catalogo finiture

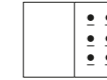

fabrics / tessuti

→ see booklet for finishes
vedi catalogo finiture

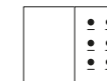

solid laminate top / ripiano in stratificato

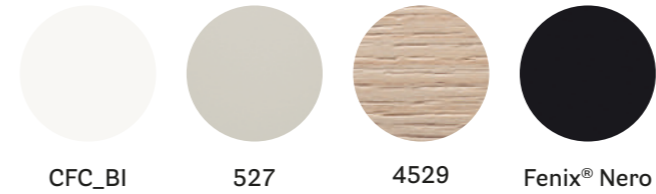

ACCESSORI / ACCESSORIES

powder coated / verniciato

→ see booklet for finishes
vedi catalogo finiture

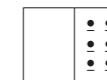

Buddyhub sideboard

Friendly spirit

DESIGN
Busetti Garuti Redaelli, 2024

EN — Buddyhub Sideboard is a versatile piece of furniture providing storage capacity while serving as space divider, both visually and acoustically. It features a sound-absorbing panel that embraces a sideboard featuring an HPL top and three solid laminate doors in the same finish. Thanks to its versatility, it adapts to various needs and environments, such as coffee corners or meeting rooms.

IT — Buddyhub Sideboard è un arredo trasversale che unisce la funzione di contenere a quella di separare gli ambienti, sia visivamente che acusticamente. È caratterizzato da un pannello fonoassorbente perimetrale che abbraccia un mobile contenitore caratterizzato da un ripiano in stratificato con tre ante in laminato. Grazie alla sua versatilità, si adatta a diverse esigenze e ambienti, come la zona dedicata alla pausa caffè o all'interno delle sale riunioni.



Sideboard

Mobile contenitore

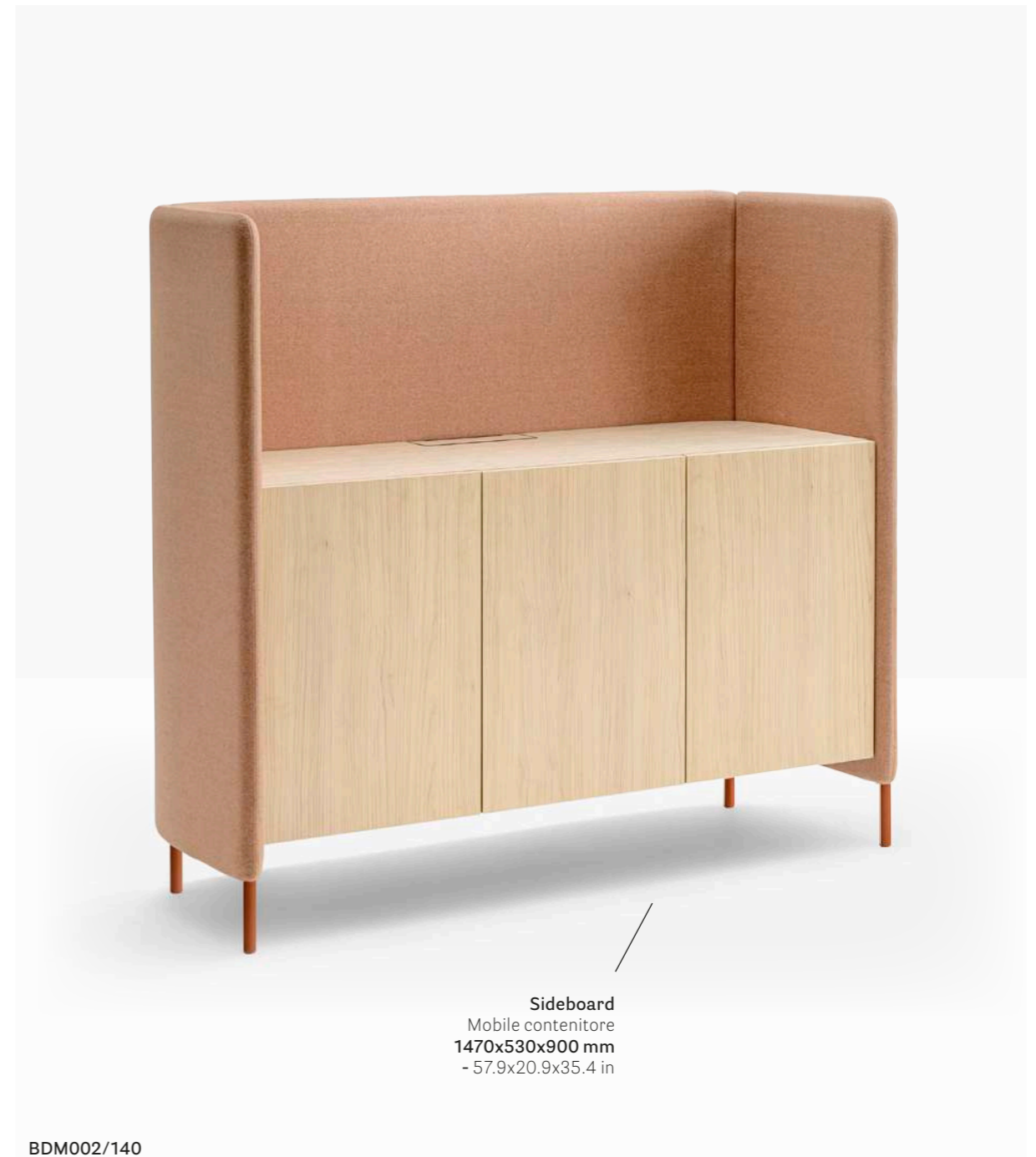

Sideboard
Mobile contenitore
1470x530x900 mm
- 57.9x20.9x35.4 in

BDM002/140

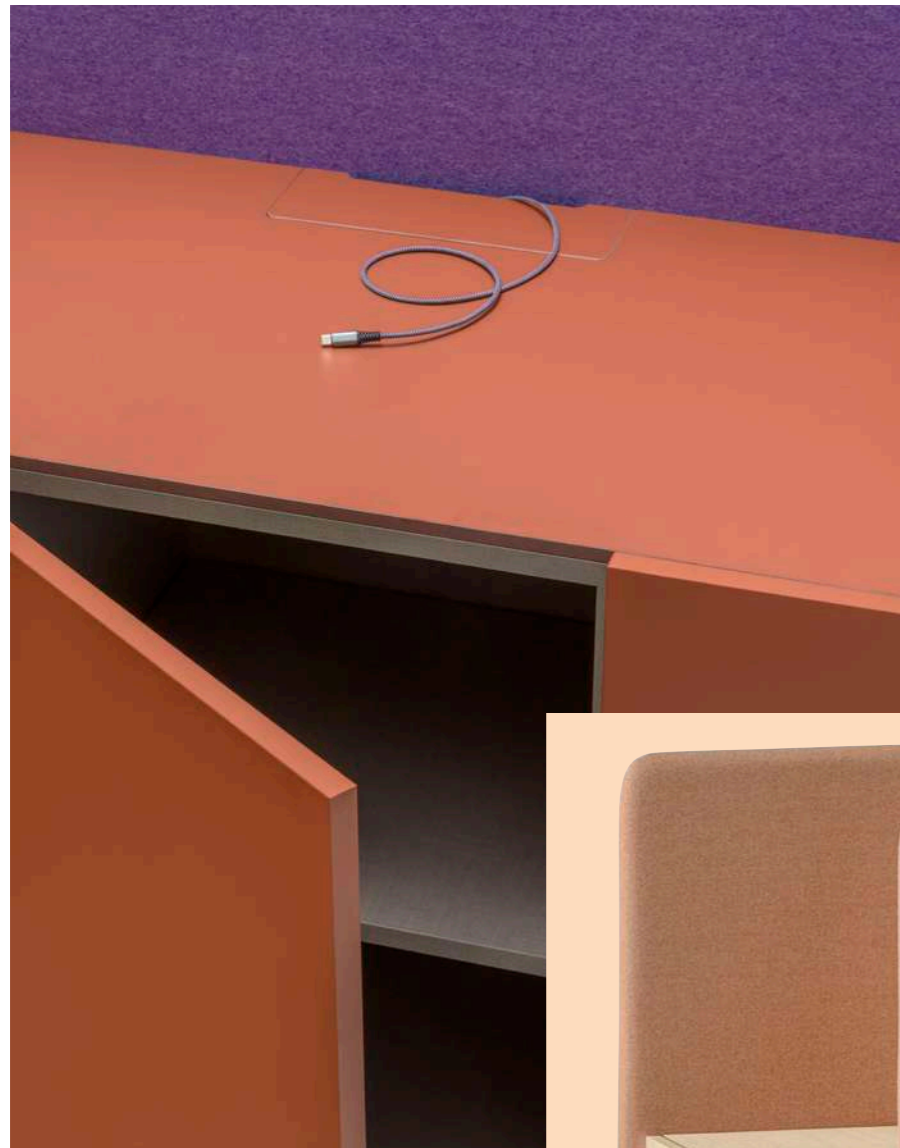

Water-resistant top with cable duct
Piano d'appoggio resistente all'acqua con canalina passacavi



HPL top, laminate doors available in oak wood finish, white, or Fenix® colours
Ripiano in stratificato e ante in laminato color rovere, bianco o Fenix®



Sound-absorbing panel
Pannello fonoassorbente
1400 mm - 55.1 in

Aluminium legs
Gambe in alluminio

Arki-Stool

A perfect balance

DESIGN
Pedrali R&D, 2017

EN — Arki-Stool joins Arki collection which reviews the industrial look in a functional way. A steel footrest on the legs creates a nice contrast to the naturalness of the wood.

IT — Arki-Stool amplia la collezione Arki che rivisita il look industriale in chiave funzionale. Un poggiatesta in acciaio abbraccia le gambe, creando un piacevole contrasto con la naturalezza del legno.



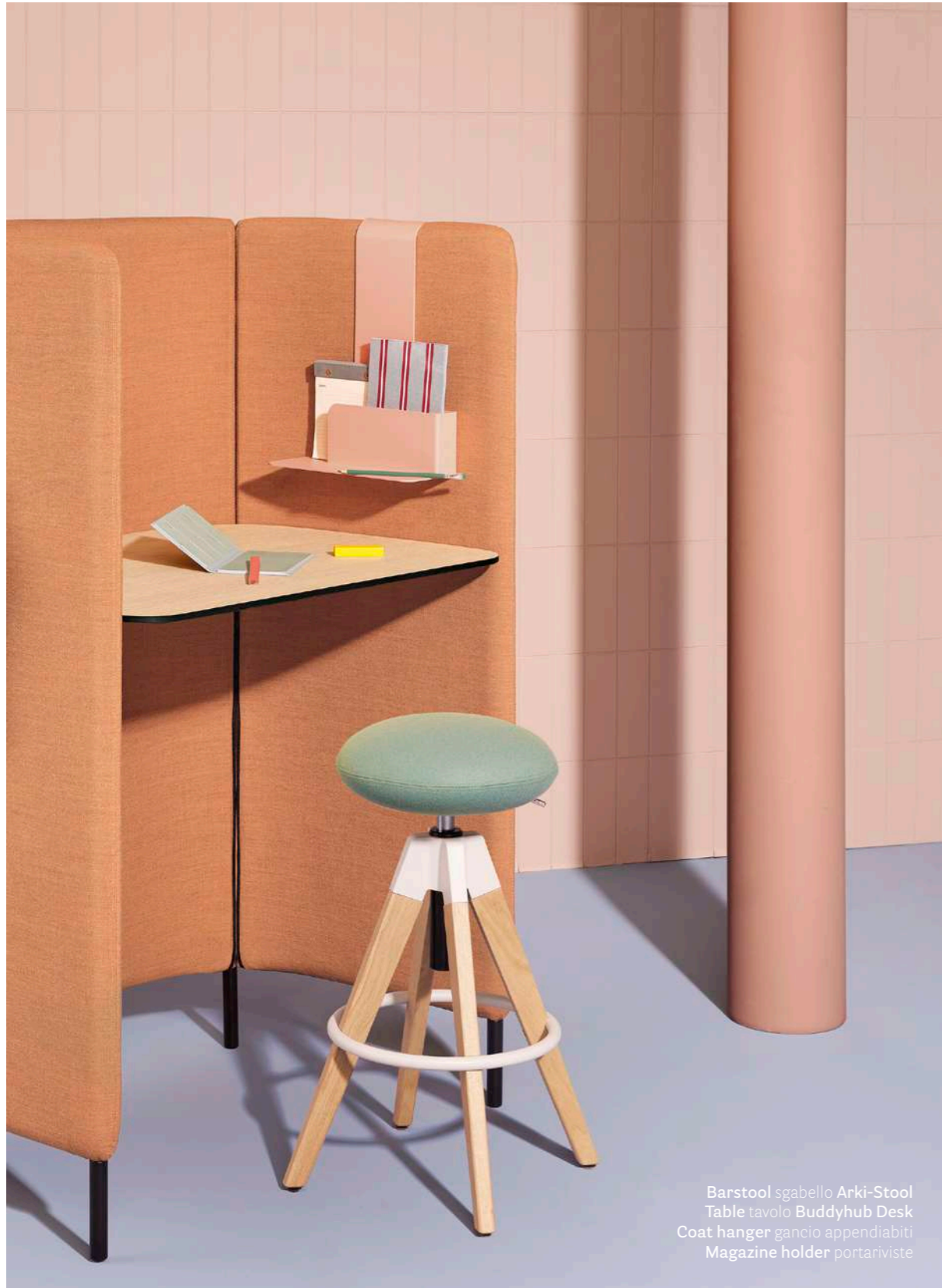

Barstool sgabello Arki-Stool
Table tavolo Buddyhub Desk
Coat hanger gancio appendiabiti
Magazine holder portariviste

Barstool Sgabello



ARKW6/2

BARSTOOL / SGABELLO

Upholstered seat
Seduta imbottita



Height
Altezza
650÷750 mm
25.6÷29.5 in

Height
Altezza
550÷650 mm
21.6÷25.6 in



Orange Polska

Warsaw, Poland

Project: Office

Architect: Jander Kabza Architects

Products: Arki-Stool barstool





BIC offices

Sofia, Bulgaria

Project: Offices

Architect: Guillaume Coquete
with MoVe Architects

Products: Arki-Stool

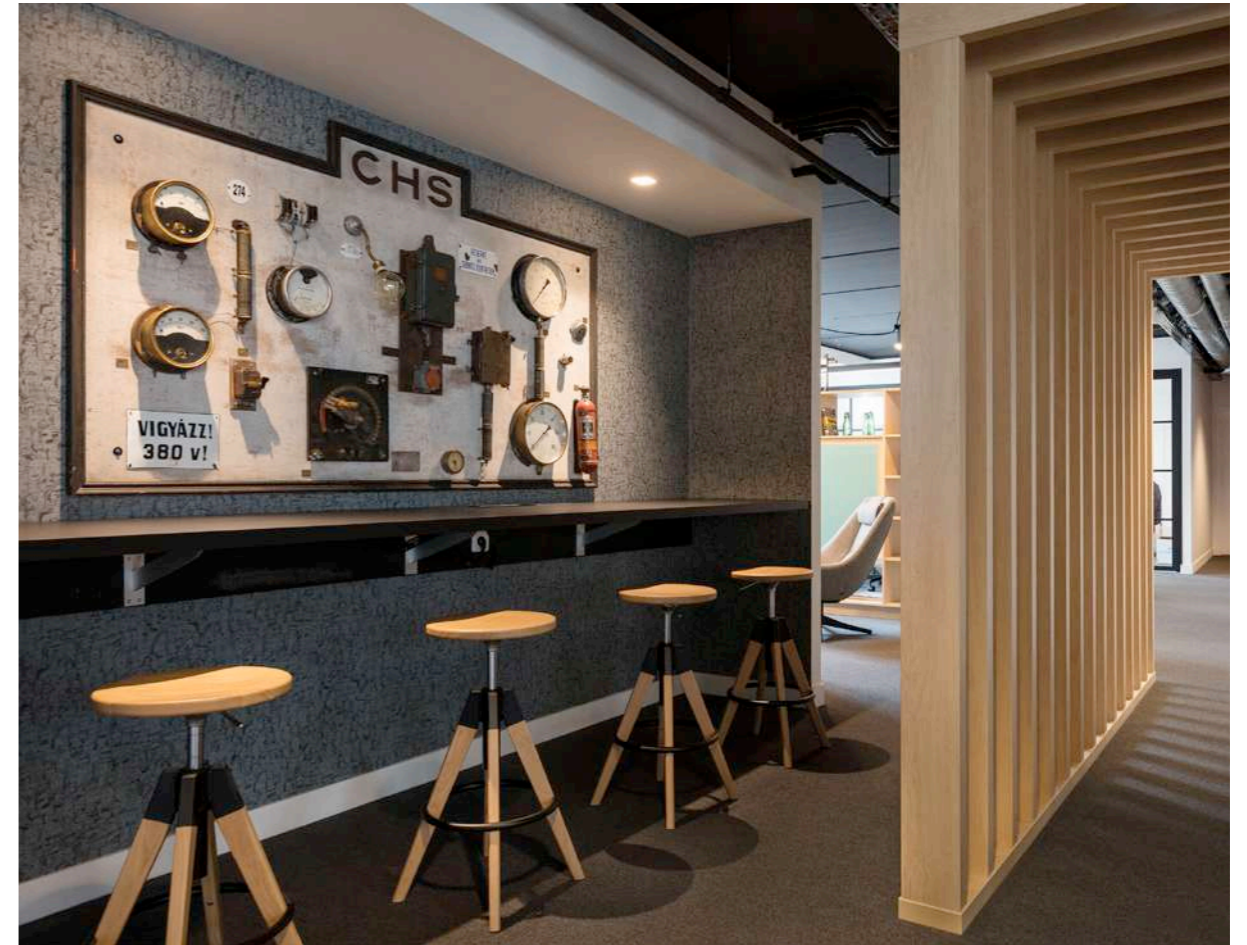

FREY Offices

Paris, France

Project: Offices

Products: Arki-Stool



deWol Industries hub

Milan, Italy

Project: Offices

Architect: Isacco Brioschi Architects

Products: Arki-Stool

SIZES / DIMENSIONI

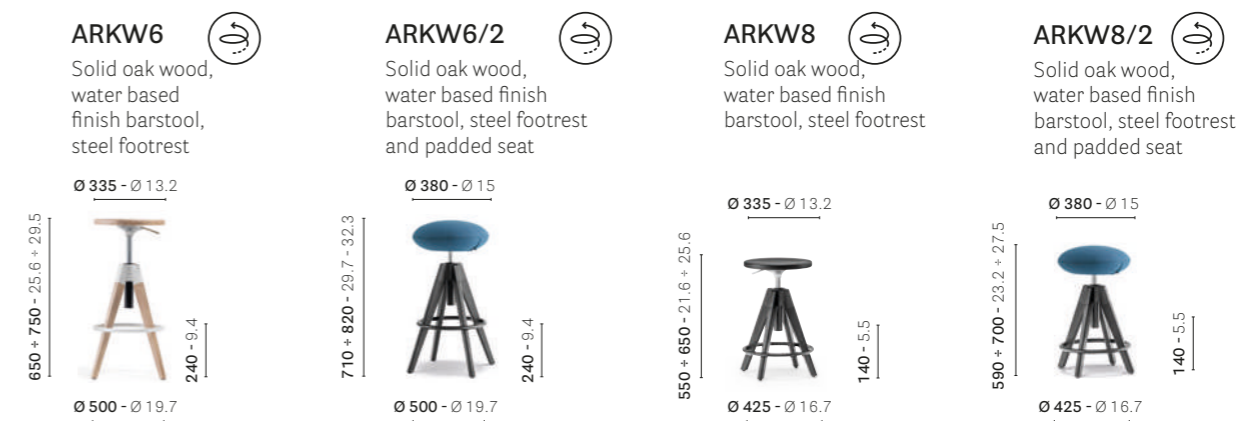

FINISHES / FINITURE

steel / acciaio

coated oak
rovere verniciato

lacquered oak with visible grains
rovere laccato a poro aperto



B1100

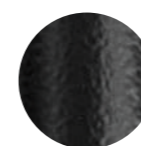

NERO



RS
Bleached oak
Rovere sbiancato

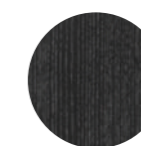

AN
Black
Nero

fabrics and powder coated
tessuti e verniciato

→ see booklet for finishes
vedi catalogo finiture

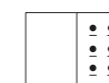

CERTIFICATES / CERTIFICAZIONI

Safety, strength and durability tests / Prove di sicurezza, resistenza e durata
EN 1728:2012+AC2013 — EN 16139:2013 level 2



Ikon

More than just a cone

DESIGN
Pio e Tito Toso, 2012

EN — Ikon speaks the language of architecture in its highest expression of simplicity and elegance. Tables with conical base made of polypropylene or polyethylene combined with tops in different sizes and finishes.

IT — Ikon parla il linguaggio dell'architettura nella sua massima espressione di semplicità e pulizia formale. Tavoli con base conica realizzata in polipropilene o polietilene abbinata a ripiani in diverse dimensioni e finiture.





Table tavolo Ikon
Solid laminate top ripiano in stratificato
Side chair sedia Babila
Lighting lampade L002

Table Tavolo

Rotational moulding
polyethylene base
Base in polietilene
stampata rotazionale
1060 mm - 41.7 in



867

Rotational moulding
polyethylene base, to be filled
Base in polietilene rotazionale,
da zavorrare
Ø 550 mm - 21.6 in



869

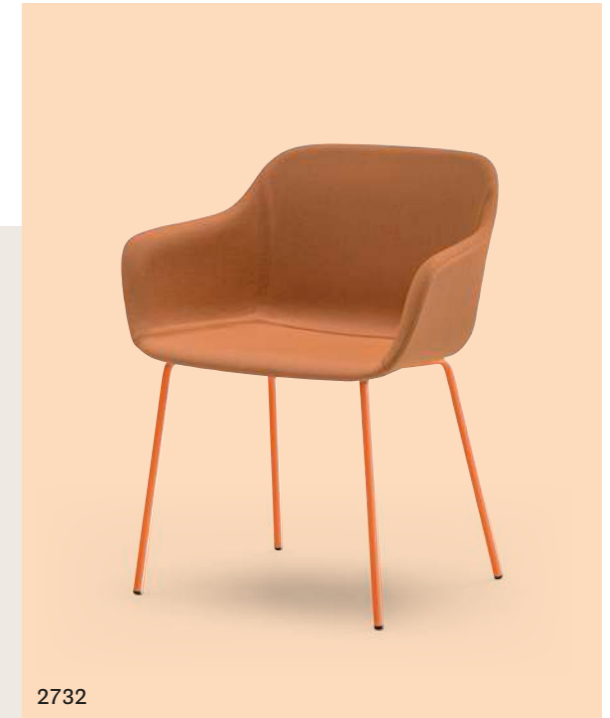

Pouf

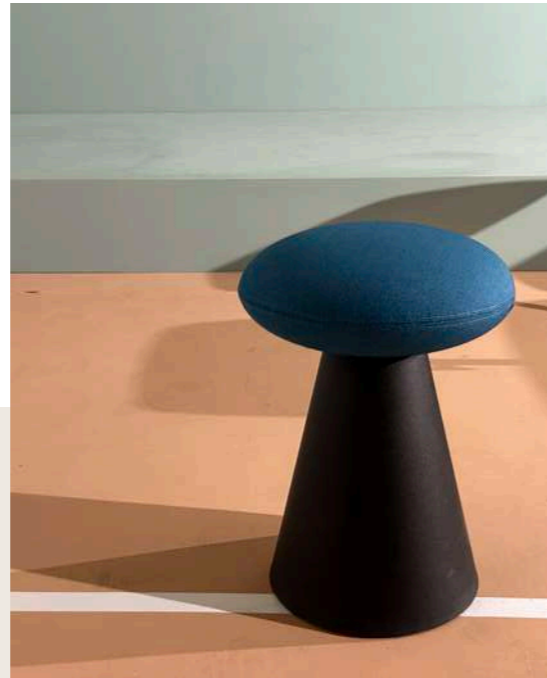

Polyurethan injected
foam seat upholstered in fabric
Sedile in schiumato poliuretano
rivestito in tessuto



Injection-moulded
polypropylene base
Base in polipropilene
stampato a iniezione

869 + 862

WORKSPACE



Box Buddyhub
Pouf Ikon



Bankhotel

Lviv, Ukraine

Project: Hotel

Architect: KUDIN architects

Products: Ikon table and poseur table, Tweet side chair and barstool

Confidential Office in Dubai

Dubai, UAE

Project: Office

Architect: a2z Office

Products: Ikon table, Babila side chair, Elliot table





#PedraliWorkspaces

Orgatec 2022
Cologne, Germany

Project: Exhibition stand
Products: Ikon table, Héra armchair,
Hevea pot-holder

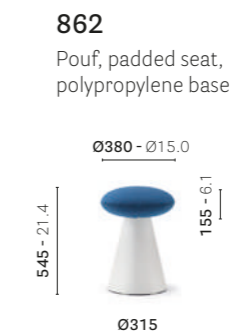
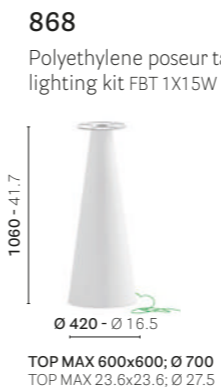

IKT 240/300X100

Table with polyethylene bases, solid laminate top and aluminium frame



IKT 240/300/360X120

Table with polyethylene bases, solid laminate top and aluminium frame



IKT 300X100 CC

Table with polyethylene bases, solid laminate top and aluminium frame, cable management (1000x42 - 39.4x1.6)



IKT 300X100 CC60

Table with polyethylene bases, solid laminate top and aluminium frame, cable management (1000x60 - 39.4x2.4)



IKT 240/300X100 CCO

Table with polyethylene bases, solid laminate top and aluminium frame, cable management (600x150 - 23.6x5.9)



IKT 300/360X120 CC

Table with polyethylene bases, solid laminate top and aluminium frame, cable management (1000x42 - 39.4x1.6)



IKT 300/360X120 CC60

Table with polyethylene bases, solid laminate top and aluminium frame, cable management (1000x60 - 39.4x2.4)



IKT 240/300/360X120 CCO

Table with polyethylene bases, solid laminate top and aluminium frame, cable management (600x150 - 23.6x5.9)



polypropylene and polyethylene / polipropilene e polietilene



solid laminate top / ripiano in stratificato

tops / ripiani



→ see catalogue Tables 02
vedi catalogo Tavoli 02

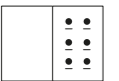

polyethylene legs / gambe in polietilene

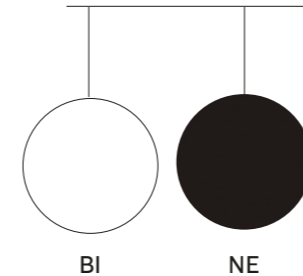

POUF FINISHES / FINITURE POUF

polypropylene / polipropilene

fabrics / tessuti

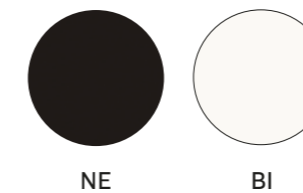

→ see booklet for finishes
vedi catalogo finiture

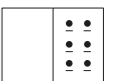

Modus

Soft atmospheres

DESIGN
Pedrali R&D, 2010

EN — Modus is a new innovative collection of upholstered modular seatings, designed to guarantee absolute flexibility during assembly and installation phases. Linear, corner, double-seating and back-to-back compositions allow several custom made solutions.

IT — Modus è un'innovativa collezione di sedute modulari imbottite, progettata per garantire un'assoluta flessibilità in fase di assemblaggio e installazione. La composizione dei moduli lineari, bifacciali e angolari permette di creare varie configurazioni d'arredo.



Modular seating seduta modulare Modus
Armchair poltrona Vic
Table tavolo Inox
Lighting lampada L001



Modular seating seduta modulare Modus
Armchair poltrona Osaka
Side chair sedia Osaka
Table tavolo Inox
Lighting lampada L001



Modular seating Seduta modulare

Laminate or Fenix®
shelf with MDF core
Mensola in laminato
o Fenix® con anima in MDF



Back to back unit,
smooth upholstery
Modulo bifacciale,
rivestimento liscio



Corner unit
at 90 degrees
Modulo angolare
a 90 gradi



Triple curved unit
at 60 degrees
Tripla curva singola
a 60 gradi





Sky Italia

Milan, Italy

Project: Office

Architects: DEGW - brand of Lombardini22
(Interior Design & Space Planning)

Products: Modus modular seating,
Grace armchair, Arki-Table, Inox table



MODUS

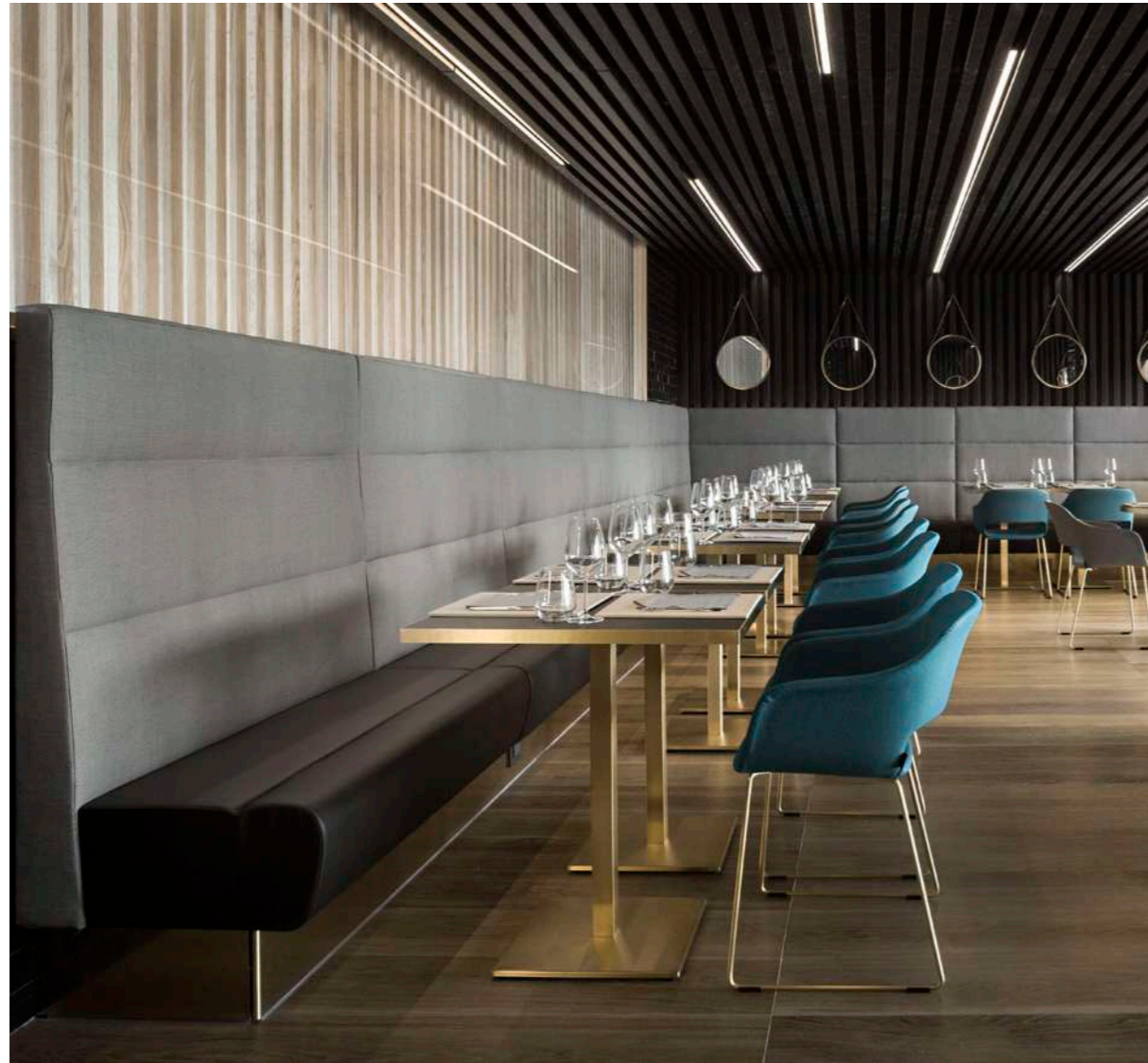

Kilometro Rosso

Bergamo, Italy

Project: Company Canteen
Architect: Luca Bombassei Studio
Products: Babila armchair, Inox table,
 Modus modular seating

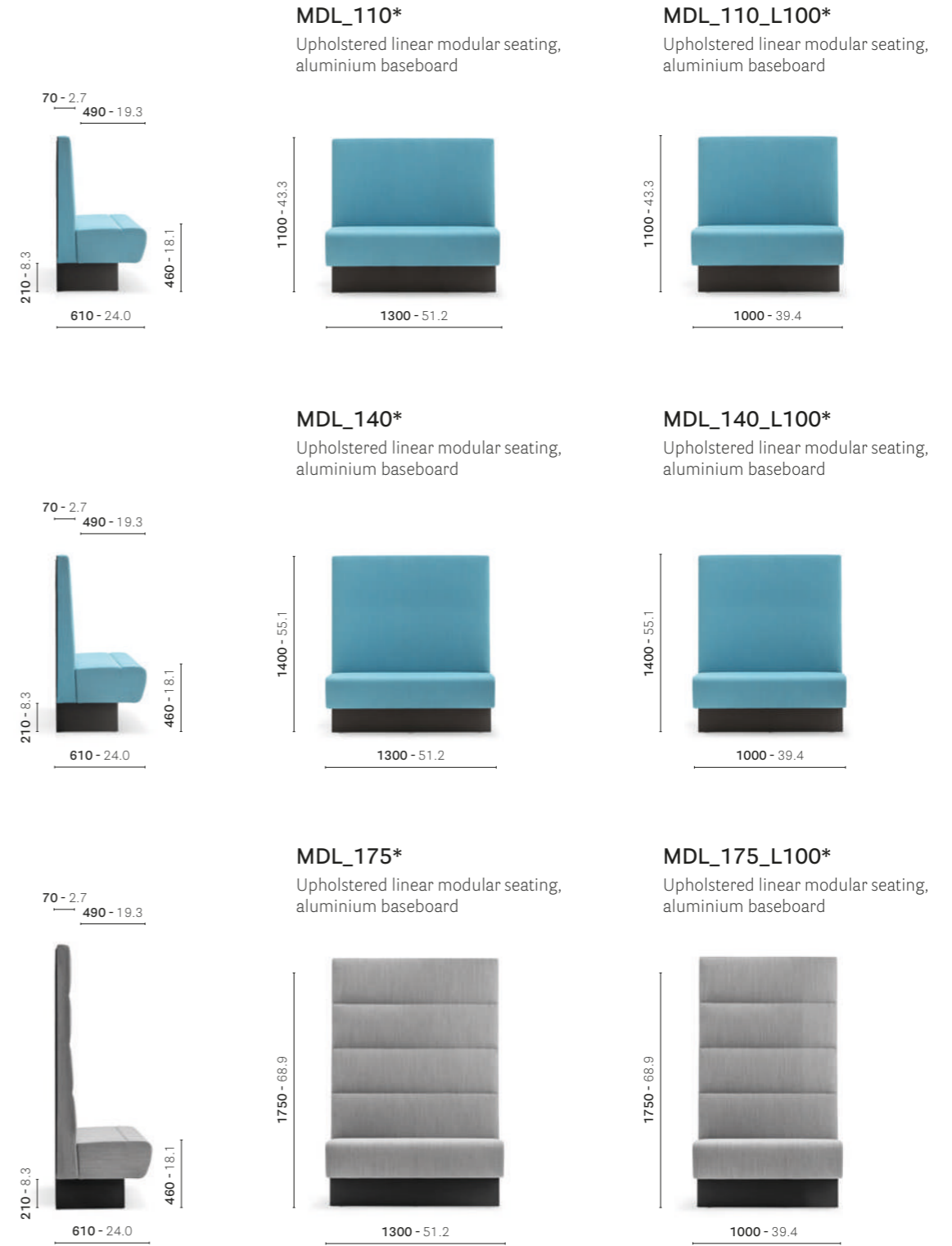

*Free standing / Autoportante

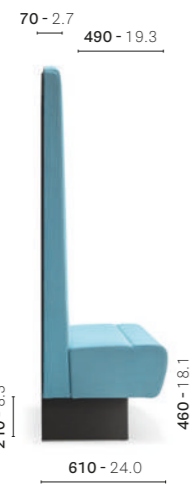

MDL_240

Upholstered linear modular seating, aluminium baseboard



MDL_240_L100

Upholstered linear modular seating, aluminium baseboard

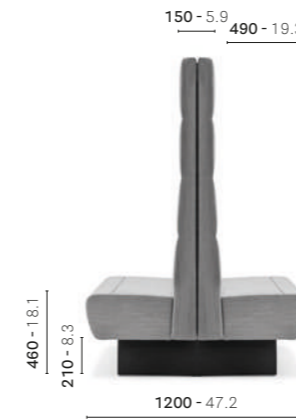
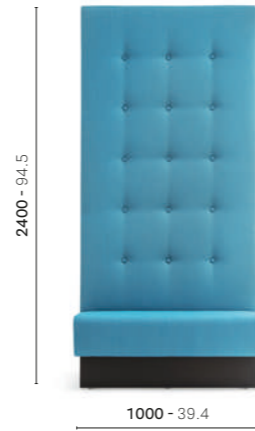

MDB_175*

Upholstered back to back modular seating, aluminium baseboard



MDB_175_L100*

Upholstered back to back modular seating, aluminium baseboard

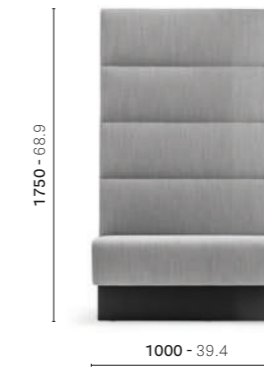

MDB_110*

Upholstered back to back modular seating, aluminium baseboard

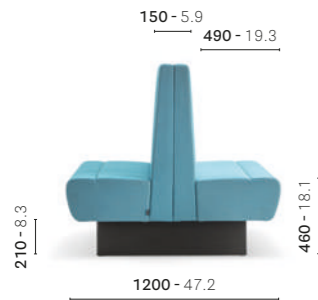

MDB_110_L100*

Upholstered back to back modular seating, aluminium baseboard



MDA_110*

Upholstered corner modular seating, aluminium baseboard

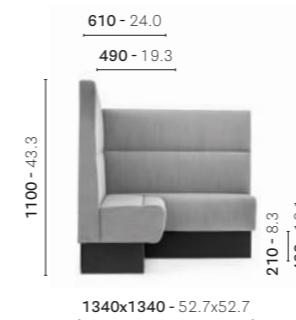

MDA_140*

Upholstered corner modular seating, aluminium baseboard



MDA_175*

Upholstered corner modular seating, aluminium baseboard



MDA_240

Upholstered corner modular seating, aluminium baseboard

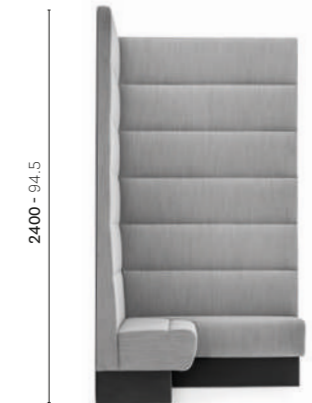

MDB_140*

Upholstered back to back modular seating, aluminium baseboard

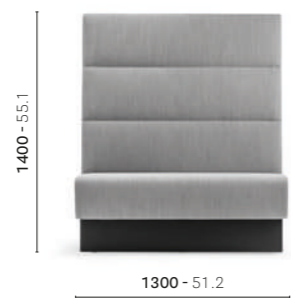

MDB_140_L100*

Upholstered back to back modular seating, aluminium baseboard



MDAB_110*

Upholstered corner back to back modular seating, aluminium baseboard

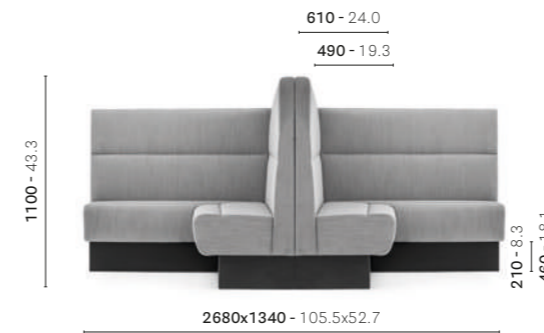

MDAB_140*

Upholstered corner back to back modular seating, aluminium baseboard



*Free standing / Autoportante

*Free standing / Autoportante

MDAB_175*

Upholstered corner back to back modular seating, aluminium baseboard



custom made sized / misura su richiesta

MD5

Backside laminate or upholstered panel
Pannello posteriore in laminato o imbottito
THICKNESS: 30 - 1.18

MDP_110*

Upholstered linear modular seating, aluminium baseboard

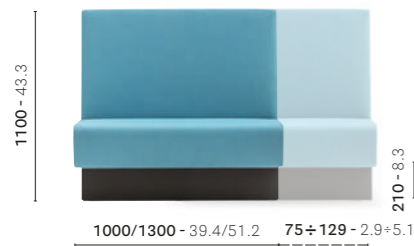

MDP_140*

Upholstered linear modular seating, aluminium baseboard

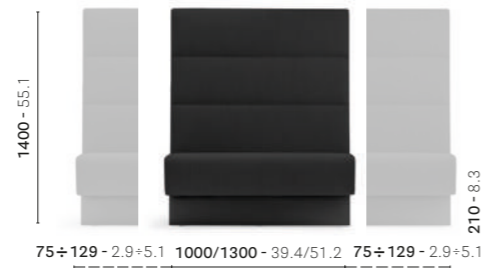

MDP_175*

Upholstered linear modular seating, aluminium baseboard

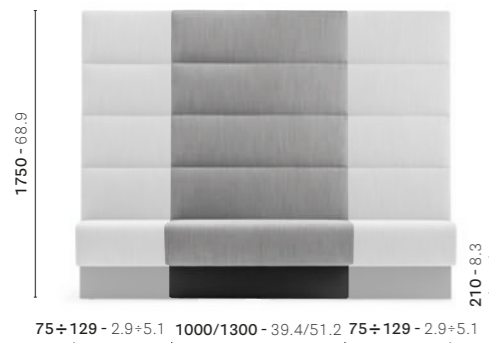

MDP_240

Upholstered linear modular seating, aluminium baseboard

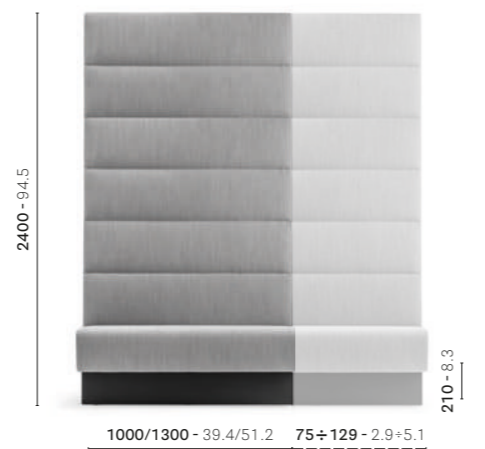

*Free standing / Autoportante

MODUS 2.0

MD/2L_110*

Upholstered linear modular seating, aluminium baseboard

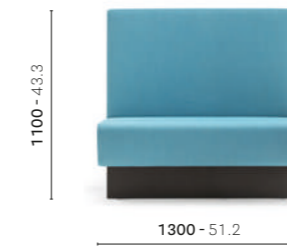
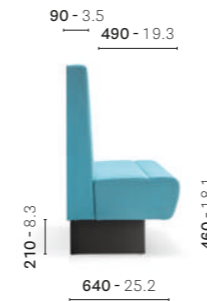

MD/2L_110_L100*

Upholstered linear modular seating, aluminium baseboard

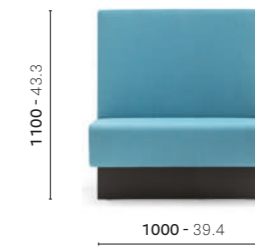

MD/2L_140*

Upholstered linear modular seating, aluminium baseboard

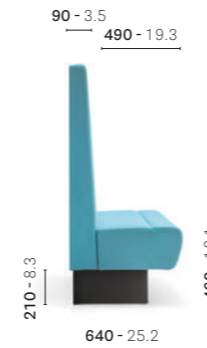

MD/2L_140_L100*

Upholstered linear modular seating, aluminium baseboard

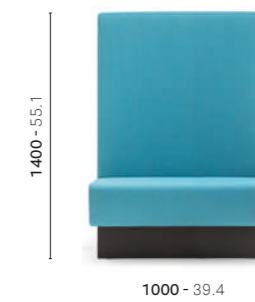

MD/2A_110*

Upholstered corner modular seating, aluminium baseboard

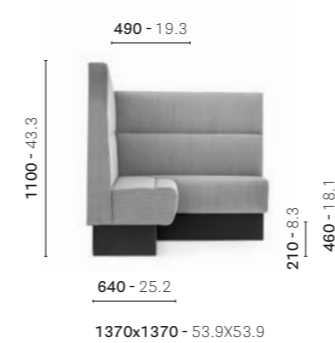

MD/2A_140*

Upholstered corner modular seating, aluminium baseboard



K_MD/2L

Back shelf for linear version bench
Mensola posteriore per panca lineare
THICKNESS: 40 - 1.57

K_MD/2A

Back shelf for corner unit bench
Mensola posteriore per panca angolare
THICKNESS: 40 - 1.57

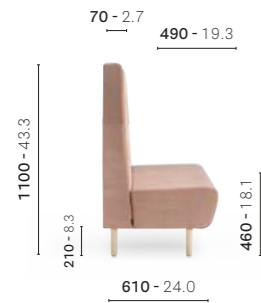

MDWL_110
Upholstered linear modular seating, solid ash wood legs



MDWL_110_L100
Upholstered linear modular seating, solid ash wood legs



MDWL_140
Upholstered linear modular seating, solid ash wood legs



MDWL_140_L100
Upholstered linear modular seating, solid ash wood legs

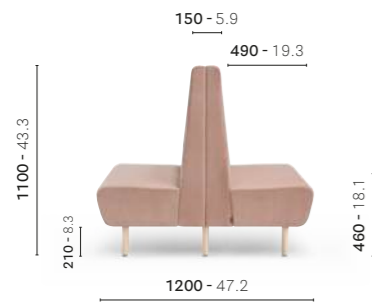

MDWB_110
Upholstered linear modular seating, solid ash wood legs



MDWB_110_L100
Upholstered linear modular seating, solid ash wood legs

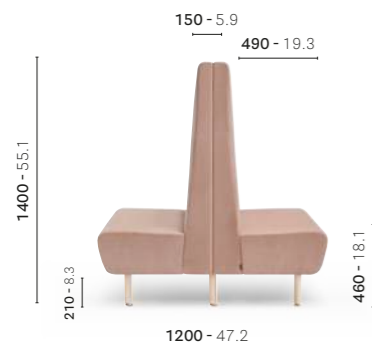

MDWB_140
Upholstered linear modular seating, solid ash wood legs



MDWB_140_L100
Upholstered linear modular seating, solid ash wood legs



MD/2C60_140*

Upholstered modular seating, aluminium baseboard, single / double / triple / quadruple curved unit 60°

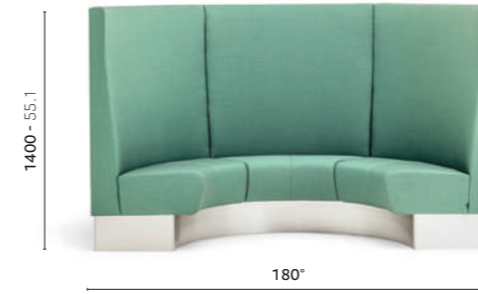

K_MD/2C60

Back curved shelf only, thickness 4cm, single / double / triple / quadruple curved unit 60°
Mensola posteriore per panca curva singola / doppia / tripla / quadrupla raggio 60°
THICKNESS: 40 - 1.57

*Free standing / Autoportante

FINISHES / FINITURE

fabrics / tessuti

→ see booklet for finishes
vedi catalogo finiture

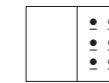

laminate for back side panel / pannello in laminato

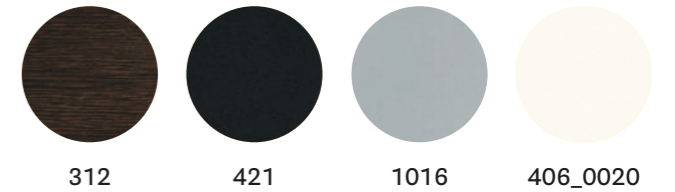

laminate for back shelf / mensola in laminato

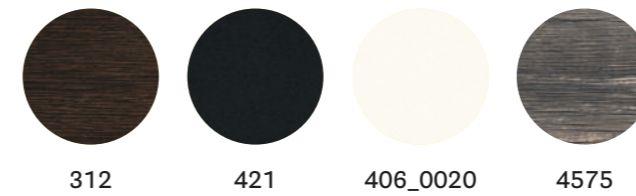

Fenix for back shelf / mensola in Fenix

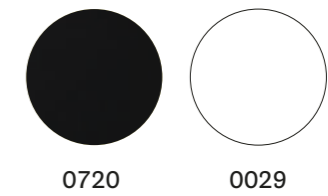

aluminium for baseboard / alluminio per zoccolo

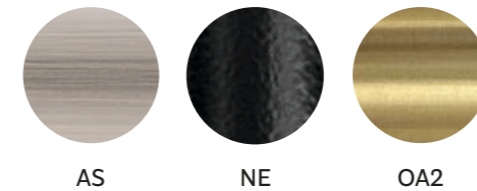

solid ash wood legs / gambe in massello di frassino



CERTIFICATIONS / CERTIFICAZIONI

Omologation "Classe 1 IM" / Omologazione "Classe 1 IM"

Nolita Sofa

Vintage chic

DESIGN
CMP Design, 2022

EN — Nolita Sofa is an outdoor sofa featuring simple and iconic shapes and a steel tube structure that provide visual rhythm and gentle proportions and ensure strength and durability. By recalling the origins of a historic course started by Mario Pedrali in 1963 with his first metal garden chairs, the Nolita Sofa keeps the collection's distinctive features of transparency and lightness, whose comfort is enhanced by soft cushions.

IT — Nolita Sofa è un divano outdoor caratterizzato da forme semplici e iconiche, dove la struttura in tubo d'acciaio dona ritmo visivo e proporzioni gentili, garantendo solidità e durevolezza. Rievocando le origini di un percorso storico iniziato da Mario Pedrali nel 1963 con le sue prime sedie da giardino in metallo, il divano Nolita conserva i tratti di trasparenza e leggerezza propri della collezione, il cui comfort viene esaltato dai morbidi cuscini.

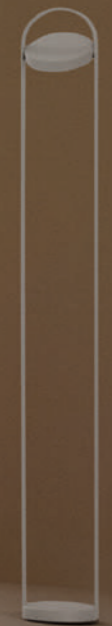

OUTDOOR

OUTDOOR

Sofa divano Nolita Sofa
Lounge armchair poltrona lounge Nofita Relax
Coffee table tavolino Circuit
Rug tappeto Twiny



OUTDOOR



OUTDOOR

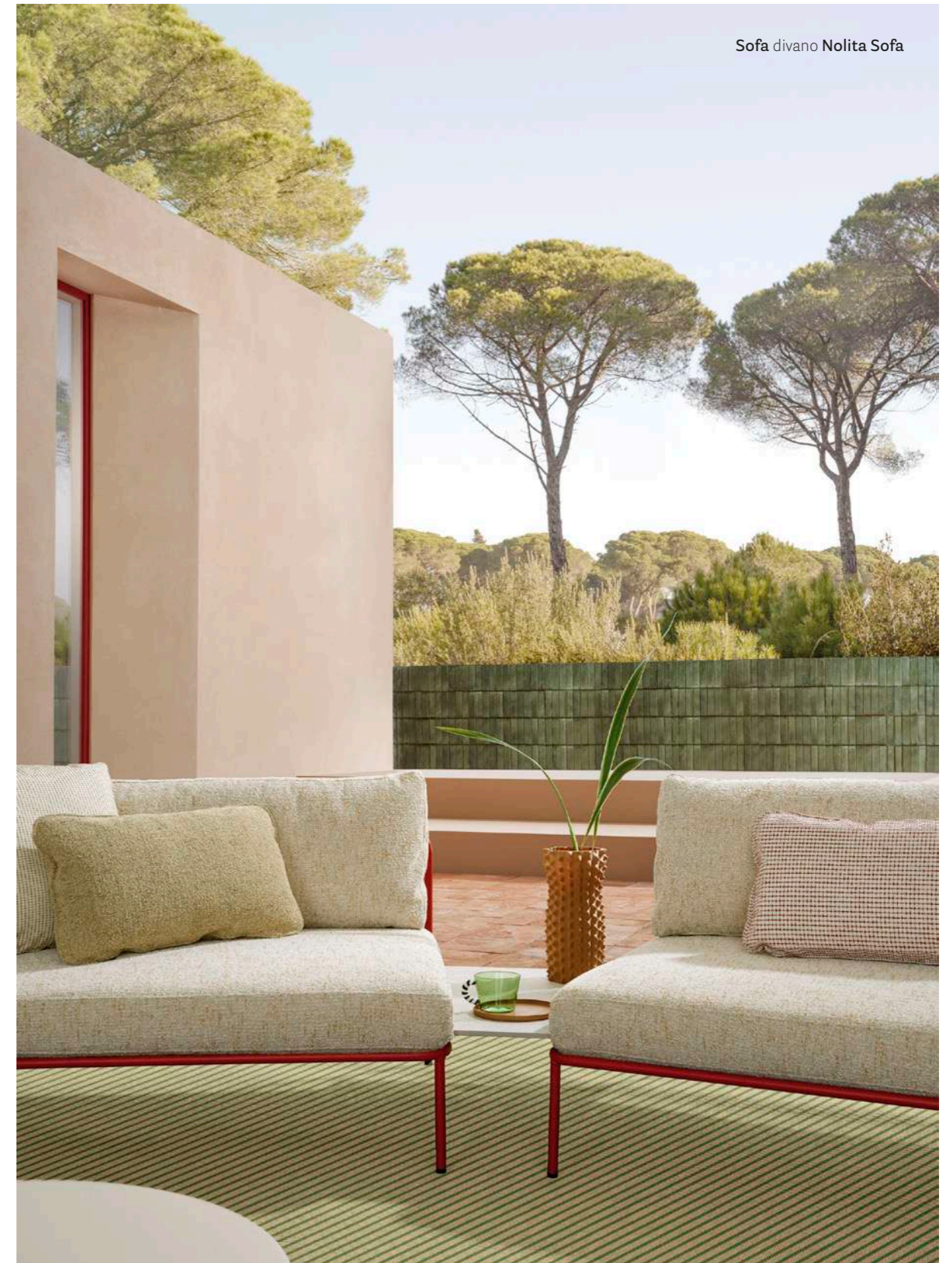

SOFA



Possibility to combine different modules:
linear or angular with right or left armrest
Possibilità di abbinare tra loro diversi moduli:
lineari o angolari con bracciolo destro o sinistro



SOFA



Sofa with steel tube frame and cushions
in polyester covered in outdoor fabric
or polypropylene fabric
Divano con struttura in tubo d'acciaio
e cuscini in poliestere rivestiti in tessuto
in polipropilene o tessuto per outdoor



SOFA

SOFA

Rectangular or 30° angular
connecting top
Ripiano di collegamento
rettangolare o angolare 30°

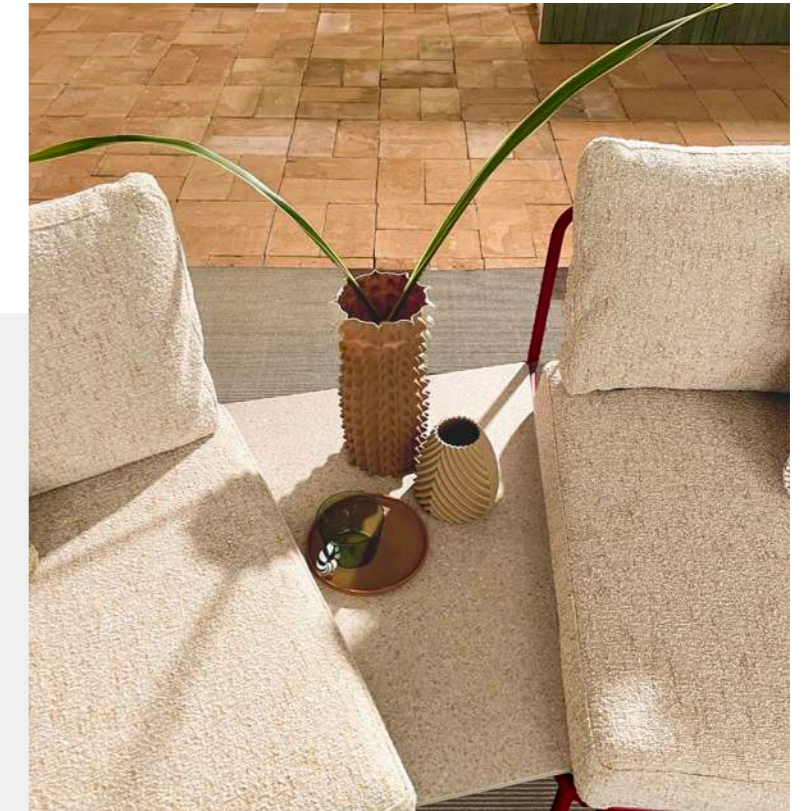

DN002 + DN001 + DN003 + DN010 + DN020

Kyano

Athens, Greece

Project: Private Home

Architect: Space is around us

Elli Athanasiadou and Olympia Katsarou

Products: Nolita Sofa, Circuit coffee table



#PedraliBacktoNature

HostMilano 2023

Milan, Italy

Project: Exhibition stand

Architect and styling: DWA Design Studio

Products: Nolita Sofa, Circuit coffee table,

Blume shelving system, Giravolta lighting

DN002 (with armrest cushion) / DN004 (without armrest cushion)

Sofa in steel tube frame, element with right armrest



DN003 (with armrest cushion) / DN005 (without armrest cushion)

Sofa in steel tube frame, element with left armrest



DN001

Sofa in steel tube frame, linear element



DN006

Lounge armchair in steel tube frame



DN010

Rectangular connecting top
THICKNESS: 30 - 1.2



DN020

Angular connecting top
THICKNESS: 30 - 1.2



Protective covers available
Disponibili coperture protettive
Pillowcases for lateral, seat and backrest cushions available
Disponibili federe cuscini laterali, sedile e schienale

We suggest to remove the cushions over night and in rainy days
Si consiglia di ritirare i cuscini durante la notte e in caso di pioggia

3001

Cushion
DEPTH: 200 - 7.9



3002

Cushion
DEPTH: 200 - 7.9



3004

Cushion
DEPTH: 170 - 6.7



3005

Cushion
DEPTH: 170 - 6.7



fabrics / tessuti

→ see booklet for finishes
vedi catalogo finiture

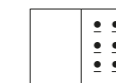

powder coated / verniciato

→ see booklet for finishes
vedi catalogo finiture

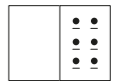

solid laminate top / ripiano in stratificato

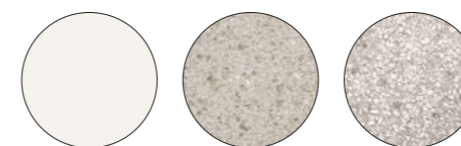

CFP_BI

3471

3467

Noa

Rational elegance

DESIGN
Marc Sadler, 2011

EN — Noa collection combines the elegance of its proportions to the comfort of the seat, all thanks to the innovative construction technique. The seat is upholstered and contained in a polycarbonate shell with a glossy outer surface.

IT — La collezione di sedute Noa unisce l'eleganza delle proporzioni al comfort della seduta grazie ad un'innovativa tecnica costruttiva. La seduta imbottita è contenuta in una scocca in policarbonato la cui superficie esterna è lucida.



Armchair poltrona Noa
Table tavolo Kuadro Desk

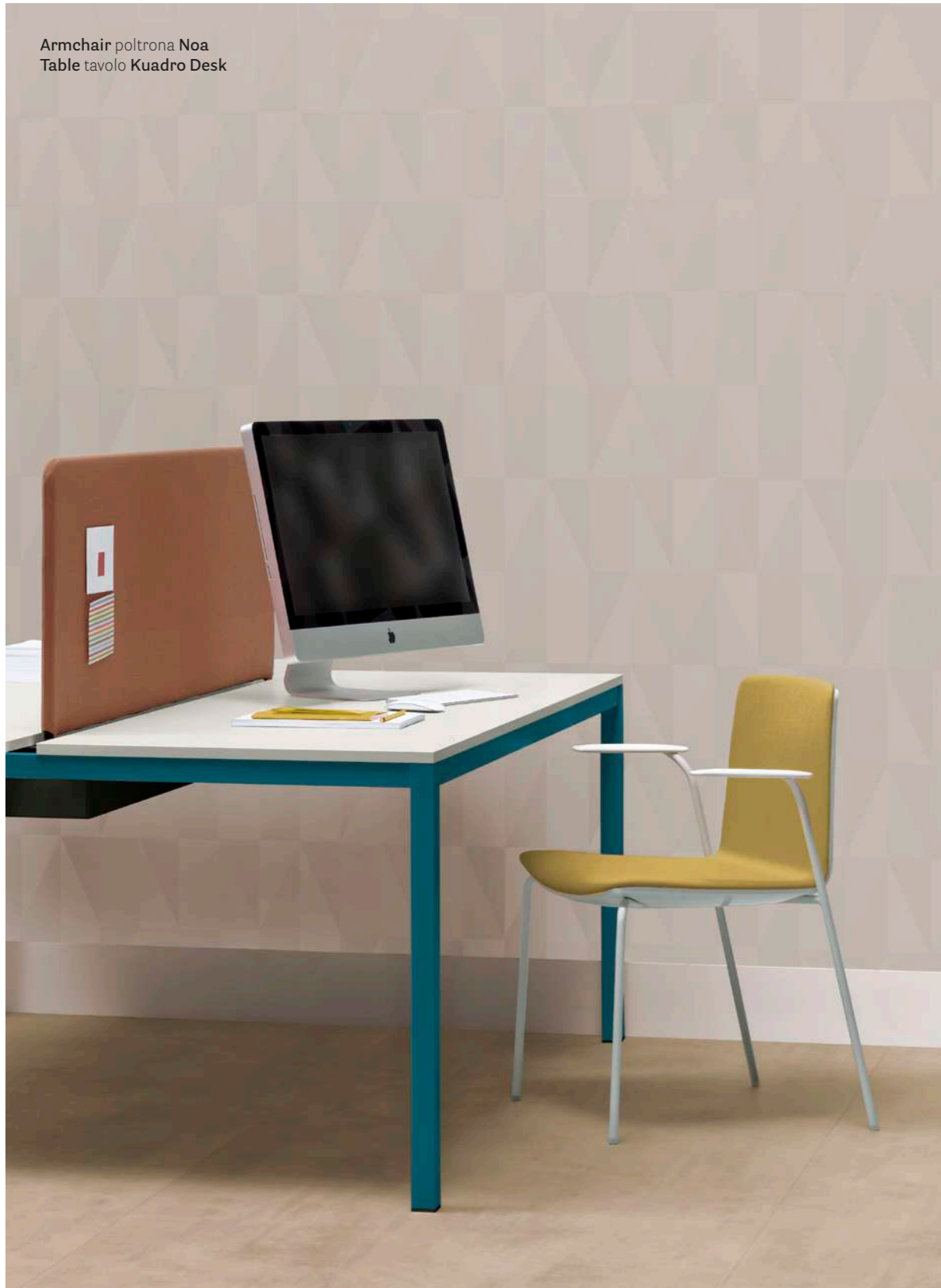

Side chair Sedia



725





728/4

Swivel seat with
spring back device
Seduta girevole
con meccanismo
di ritorno automatico

728/2



Gas lift device
Alzata a gas



728

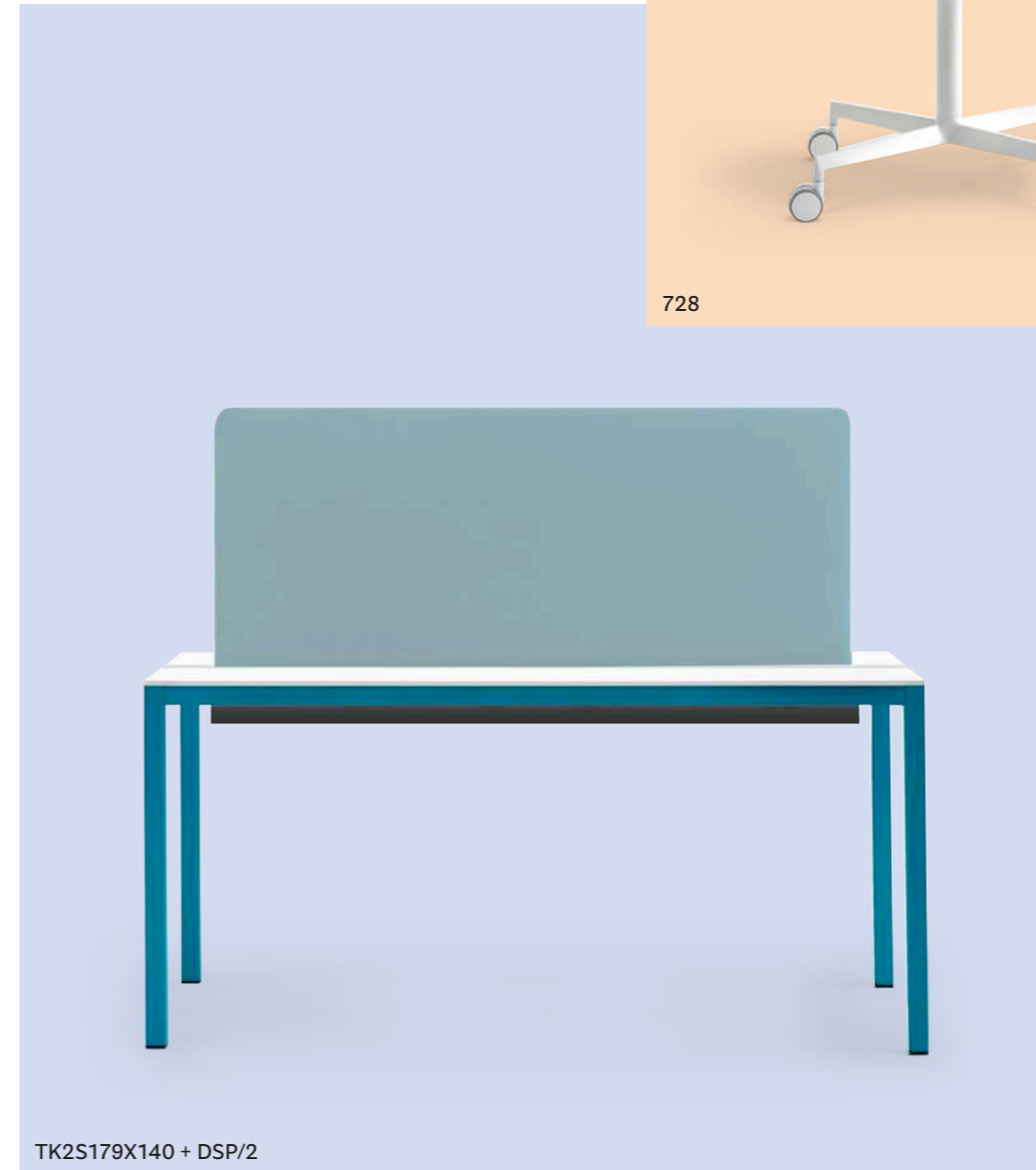

TK2S179X140 + DSP/2



WOW!House

London, United Kingdom

Project: Temporary installation
Architect and Styling: Fosbury
Architecture & Dedar
Products: Noa side chair

Unit 4

Stockholm, Sweden

Project: Office
Products: Noa armchair,
Flag clotheshanger,
Social Plus modular seating,
L001 lighting



SIZES / DIMENSIONI

mm - in

725

Side chair, upholstered front shell, polycarbonate back shell, steel tube frame



727

Side chair, upholstered front shell, polycarbonate back shell, die-cast aluminium four-spoke base with castors



727/2

Side chair, upholstered front shell, polycarbonate back shell, die-cast aluminium four-spoke base



726

Armchair, upholstered front shell, polycarbonate back shell, steel tube frame



728

Armchair, upholstered front shell, polycarbonate back shell, die-cast aluminium four-spoke base with castors



728/2

Armchair, upholstered front shell, polycarbonate back shell, die-cast aluminium four-spoke base



727/4

Side chair, upholstered front shell, polycarbonate back shell, die-cast aluminium five-spoke base with castors, adjustable in height



728/4

Armchair, upholstered front shell, polycarbonate back shell, die-cast aluminium five-spoke base with castors, adjustable in height

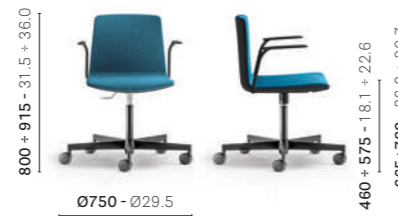

FINISHES / FINITURE

polycarbonate / policarbonato

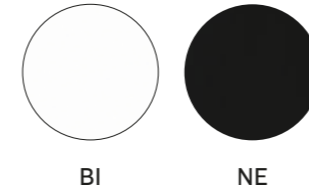

steel / acciaio

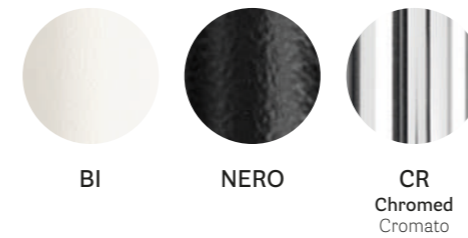

fabrics / tessuti

→ see booklet for finishes
vedi catalogo finiture

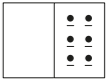

aluminium / alluminio

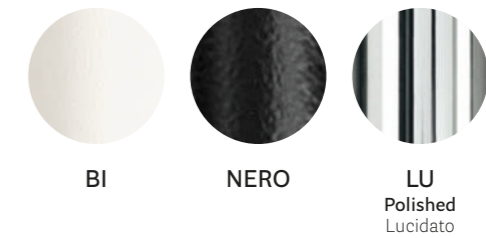

AWARDS / PREMI



CERTIFICATES / CERTIFICAZIONI

Safety, strength and durability tests / Prove di sicurezza, resistenza e durata
EN 1728:2000

Kuadro

Rigour and simplicity

DESIGN

Pedrali R&D, 2003

EN — Kuadro is a collection of tables and desks with a square profile. The desks can be supplied with upholstered dividers panels designed to separate spaces.

IT — Kuadro è una collezione di tavoli e scrivanie dal profilo squadrato. Le scrivanie possono prevedere pannelli divisorii rivestiti in tessuto per la definizione e separazione dello spazio.



Table tavolo Kuadro
Chair sedia Frida
Lighting lampada L001



WORKSPACE



WORKSPACE



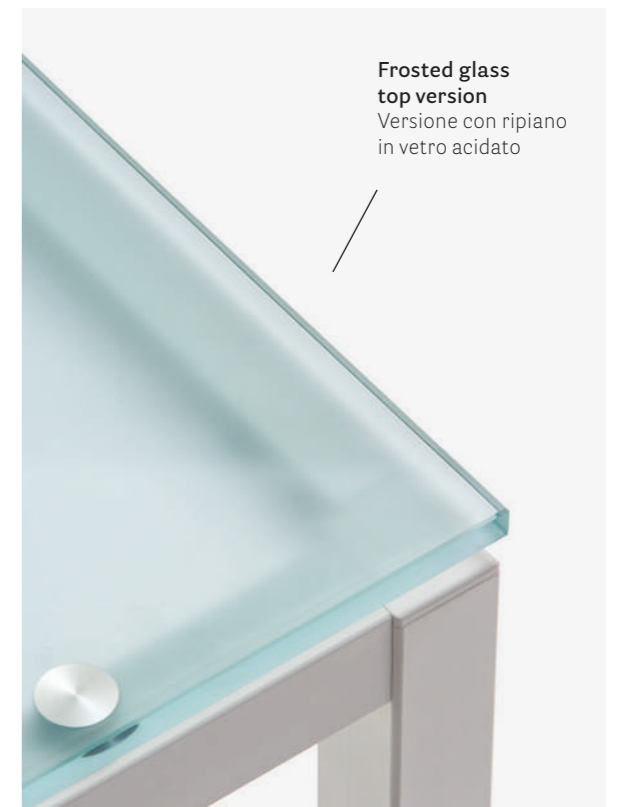
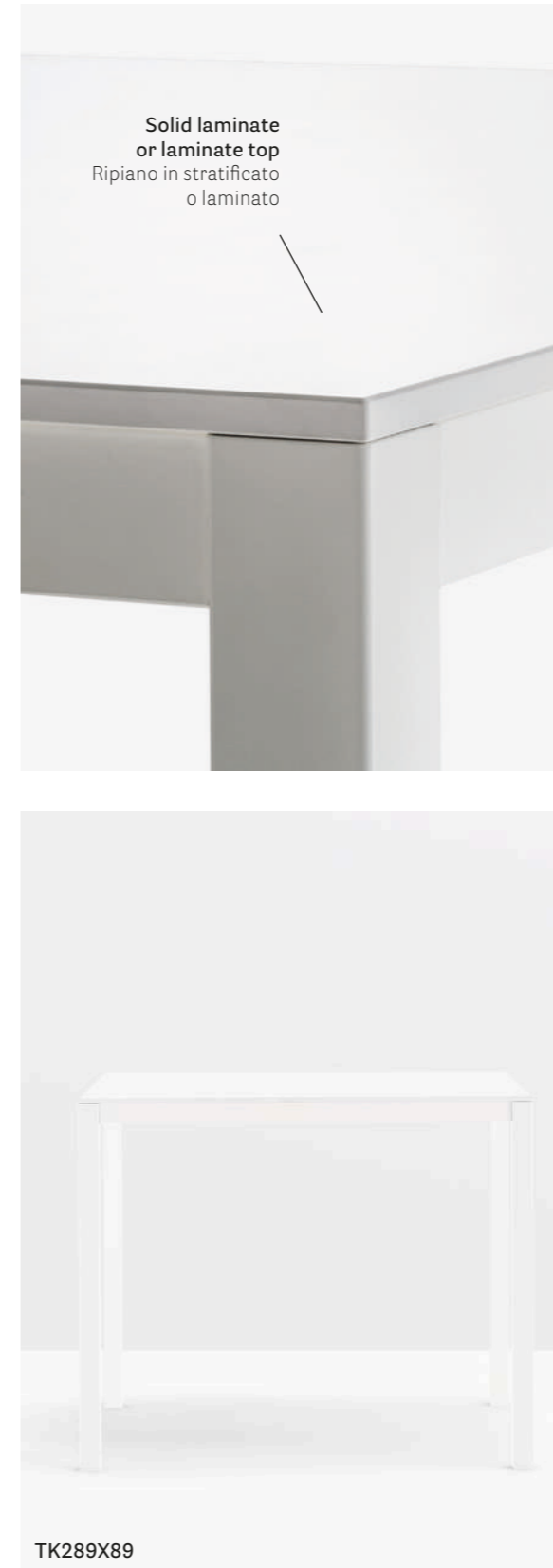



728



Square steel
tube frame
Struttura in tubo
d'acciaio a sezione
quadrata
40x40 mm
1.57x1.57 in

TK2_139X79



Luigi Bocconi University

Milan, Italy

Project: University canteen
Architect: Consuelo Redaelli
Products: Kuadro table,
Snow chair





BRAZY Lisboa

Lisboa, Portugal

Project: Office

Architects: Zutto Design e arquitectura

Products: Kuadro desk with divider, Temps task chair

TK2_69X69
Table, steel frame and solid laminate* or laminate top



TK2_79X79
Table, steel frame and solid laminate* or laminate top



TK2_89X89
Table, steel frame and solid laminate* or laminate top



TK2_119X119
Table, steel frame and solid laminate* or laminate top



TK2_119X69
Table, steel frame and solid laminate* or laminate top

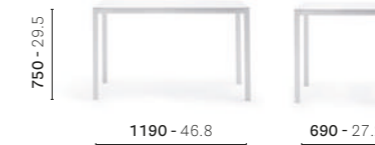

TK2_119X79
Table, steel frame and solid laminate* or laminate top



TK2_139X79
Table, steel frame and solid laminate* or laminate top



TK2_179X89
Table, steel frame and solid laminate* or laminate top

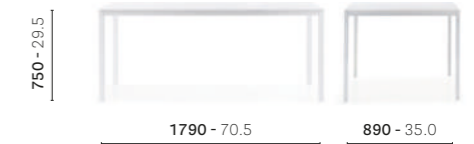

TK2S179X140
Desk Table 2 stations, steel frame, laminate top, setting for divider panel, single cable management (1500x150 - 59.1x5.9)

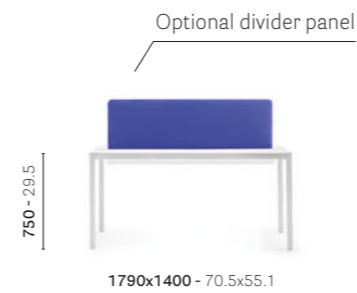

TK2S340X140
Desk Table 4 stations, steel frame, laminate top, setting for divider panel, double cable management (1500x150 - 59.1x5.9)

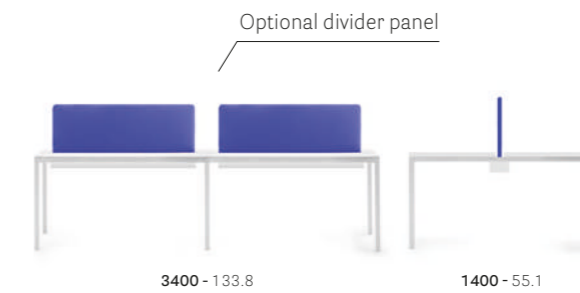

* Height of the table decreases if combined with a solid laminate top
L'altezza del tavolo diminuisce quando abbinato a ripiano in stratificato

DSP

Sound absorbing divider panel



DSP/2

Sound absorbing divider panel



TK_69X69

Table, steel frame and glass top



TK_80X80

Table, steel frame and glass top



TK_90X90

Table, steel frame and glass top



TK_120X120

Table, steel frame and glass top

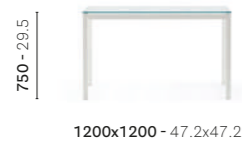

TK_120X69

Table, steel frame and glass top



TK_140X80

Table, steel frame and glass top



TK_180X90

Table, steel frame and glass top

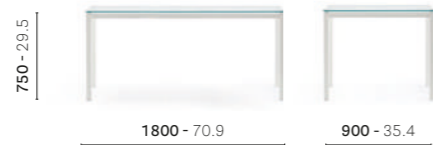

laminated top / ripiano in laminato



*Anti-fingerprint
Anti-impronta

**Recommended colours for office desks / Colori consigliati per scrivanie d'ufficio

solid laminate top
ripiano in stratificato

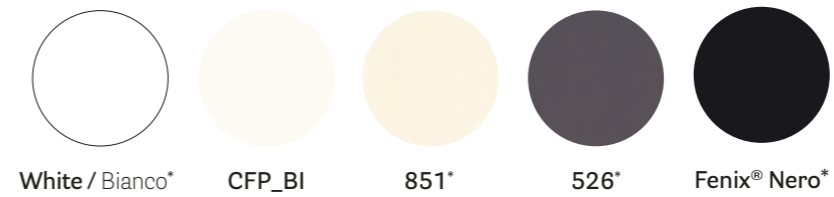

*Black core / Anima nera

tempered glass top
ripiano in vetro temperato

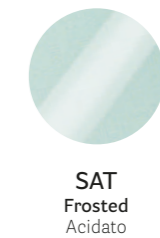

powder coated steel frame / telaio in acciaio verniciato

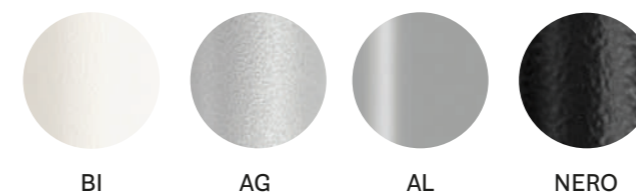

steel frame / telaio in acciaio

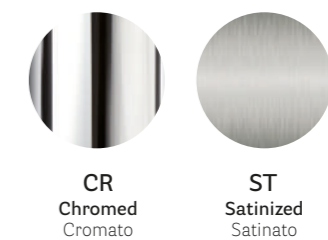

powder coated / verniciato

→ see booklet for finishes
vedi catalogo finiture



divider panel fabric / tessuto pannello divisorio

→ see booklet for finishes
vedi catalogo finiture

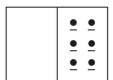

Togo

Functional Design

DESIGN
Pedrali R&D, 2010

EN — Square and essential shapes for the Togo table collection.
The legs in extruded aluminium are combined with tops of different
dimensions and finishes by means of plates in die-cast aluminium.

IT — Forme squadrate ed essenziali caratterizzano la collezione di tavoli Togo.
Le gambe in estruso di alluminio sono abbinata a ripiani di diverse dimensioni
e finiture mediante piastre in pressofusione di alluminio.



WORKSPACE



Table tavolo Togo
Side chair sedia Laja
Modular seating seduta modulare Host
Lighting lampada L002

Table Tavolo



**Solid laminate top
with powder coated aluminium legs,
outdoor finish available**
Ripiano in stratificato e struttura
verniciata anche per esterno

TG_119X79

TABLE / TAVOLO

Aluminium tube leg with
cast aluminium top plate
Gambe in tubo di alluminio
con piastra di supporto
in fusione di alluminio
40x40 mm - 1.57x1.57 in



TG_89X89



TG_159X89

TABLE / TAVOLO



880/2



TG_79X79

TG 69x69

Table, aluminium legs and plate, solid laminate / laminate* top



TG 79x79

Table, aluminium legs and plate, solid laminate / laminate* top



TG 89x89

Table, aluminium legs and plate, solid laminate / laminate* top



TG 139x139

Table, aluminium legs and plate, solid laminate / laminate* top



TG 119x79

Table, aluminium legs and plate, solid laminate / laminate* top



TG 139x89

Table, aluminium legs and plate, solid laminate / laminate* top



TG 159x89

Table, aluminium legs and plate, solid laminate / laminate* top

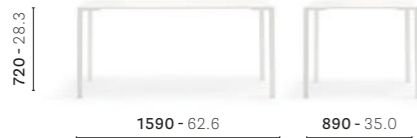

TG 199x89

Table, aluminium legs and plate, solid laminate / laminate* top

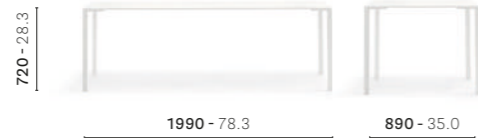

TG_H110 70x70

High table, aluminium legs and plate, laminate top



TG_H110 80x80

High table, aluminium legs and plate, laminate top



TG_H110 110x50

High table, aluminium legs and plate, laminate top



* Height of the table increases if combined with a laminate top
L'altezza del tavolo aumenta quando abbinato a ripiano in laminato

TG_H110 120x60

High table, aluminium legs and plate, laminate top

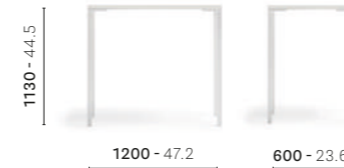

TG_H110 130x70

High table, aluminium legs and plate, laminate top

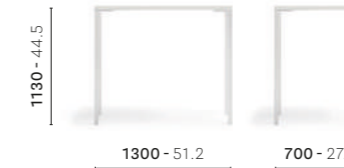

FINISHES / FINITURE

solid laminate top / ripiano in stratificato

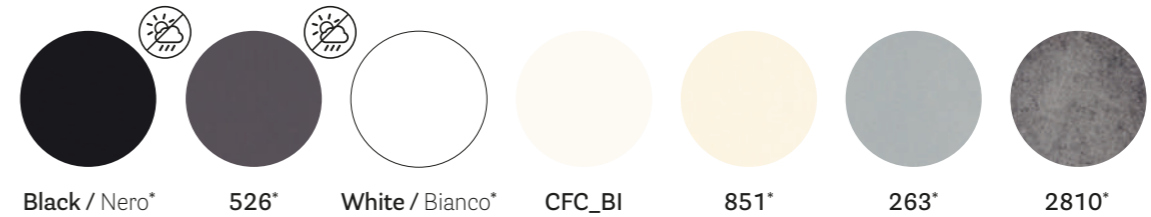

*Black core / Anima nera

laminated top / ripiano in laminato

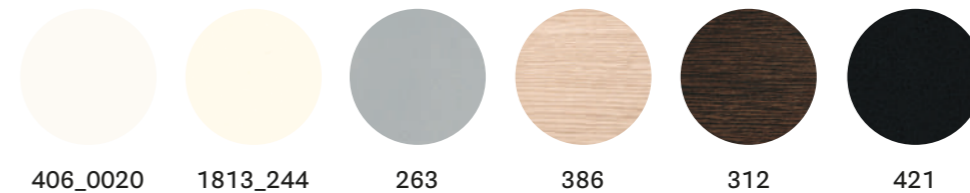

aluminium legs / gambe in alluminio



AS

powder coated / verniciato



→ see booklet for finishes
vedi catalogo finiture

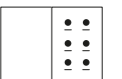

Gliss

Sinuuous shell

DESIGN

Claudio Dondoli - Marco Pocci, 2002

EN— Gliss has a cosy and ergonomic shape inspired by the iconic “Fifties” chairs, featuring a distinctive hole in the shell. The collection stands out for its comfort and functionality, given by the sinuous armrests that embrace the body and the ease of handling.

IT— Gliss è una poltrona dalla forma avvolgente ed ergonomica che si ispira alle sedute iconiche degli anni Cinquanta e si connota per l'elemento distintivo del foro sulla scocca. La collezione è confortevole e funzionale grazie alla forma sinuosa dei braccioli che cingono chi vi si siede in un abbraccio, oltre ad ottimizzarne la presa per la movimentazione.





Armchair poltrona Gliss
Table tavolo Ikon
Pouf Wow

Armchair

Poltrona



Solid ash wood legs
Gambe in massello
di frassino



905

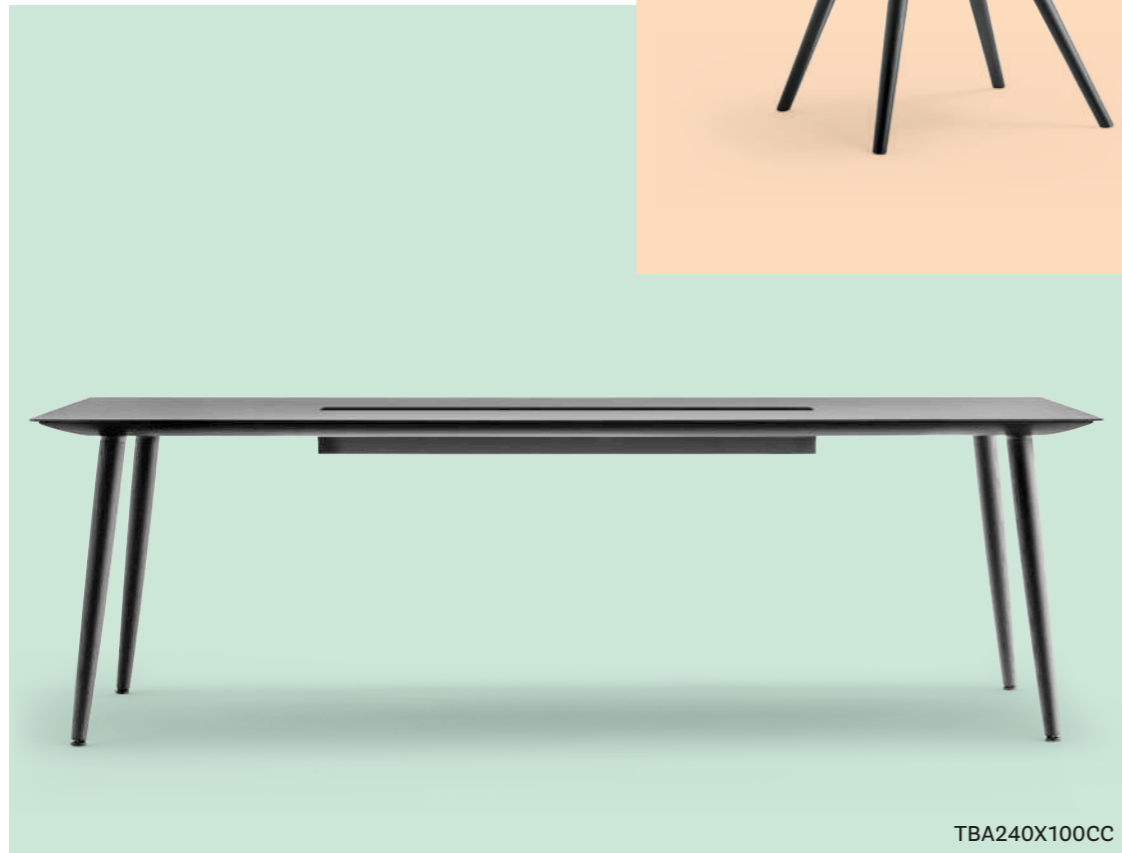

TBA240X100CC



904/F

Upholstered shell,
fabric, leather or
simil-leather covering
Scocca imbottita,
rivestita in tessuto,
cuoio o finta pelle



950/F



Swivel version, adjustable in
height with gas lift device
Versione girevole, regolabile in
altezza con meccanismo a gas

951



Barstool Sgabello

Steel rod sled
frame, two heights
Struttura a slitta in tondino
d'acciaio in due altezze
Ø 11 mm - 0.43 in

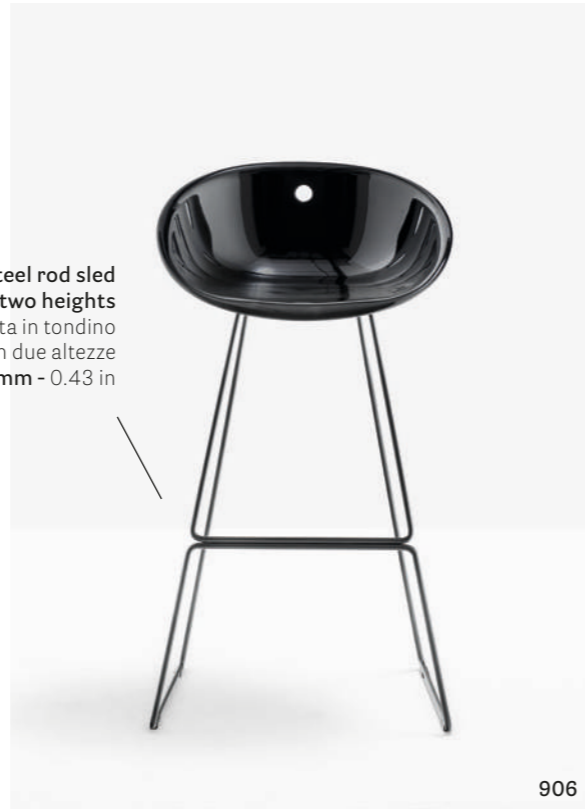

906

Swivel upholstered
shell, fabric or
simil-leather covering
Scocca girevole
imbottita, rivestita
in tessuto o finta pelle



980

Lounge armchair Poltrona lounge



360 + 340/3



Si.mobil

Ljubljana, Slovenia

Project: Office

Architect: Kragelj Arhitekti

Products: Gliss Wood armchair,
Gliss Swing lounge armchair,
Stylus table, Arod barstool

Microsoft Conference Centre

Montréal, Canada

Project: Office

Architect: Métaphore Design

Product: Gliss barstool





Copernico

Milan, Italy

Project: Office

Architect: Studio DC 10

Products: Gliss Swing, armchair and lounge armchair, Parenthesis coffee table, Zippo modular seating, Malmö barstool, armchair, lounge armchair and coffee table, Brera chair, Sign armchair, Babila side chair, Log armchair, Laja table, Ypsilon table, Arki-Table



Peri Werk

Weissenhorn, Germany

Project: Company canteen
Products: Gliss armchair, Bold table, Nemea side chair, Malmö Lounge armchair, coffee table and barstool, Nolita side chair, lounge armchair, barstool and table

900.3
Upholstered cushion only
WIDTH: 430 - 16.9



900.8
Upholstered covering only for
technopolymer armchair shell



595 - 23.4

904
Armchair, technopolymer shell,
ash wood legs



580 - 22.8 555 - 21.8

905
Armchair, polycarbonate shell,
ash wood legs



595 - 23.4 555 - 21.8

920
Armchair, technopolymer shell,
steel rod sled frame



580 - 22.8 570 - 22.4

921
Armchair, polycarbonate shell,
steel rod sled frame



595 - 23.4 570 - 22.4

921/CL1
Armchair, polycarbonate shell, steel
rod sled frame, fire-retardant grade



940
Armchair, technopolymer shell,
stainless steel central base



580 - 22.8 530 - 20.9

941
Armchair, polycarbonate shell,
stainless steel central base

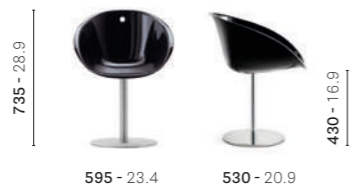

595 - 23.4 530 - 20.9

950
Armchair, technopolymer shell,
steel central base



580 - 22.8 530 - 20.9

951
Armchair, polycarbonate shell,
steel central base

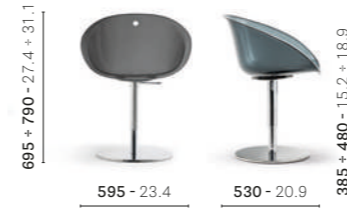

595 - 23.4 530 - 20.9

952
Armchair, polycarbonate shell,
steel central base



595 - 23.4 530 - 20.9

960/2
Armchair, technopolymer shell,
die-cast aluminium five-spoke
base with castors



Ø 750 - Ø 29.5

961/2
Armchair, polycarbonate shell,
die-cast aluminium five-spoke
base with castors



Ø 750 - Ø 29.5

968
Armchair, polycarbonate shell,
steel frame with castors



595 - 23.4 530 - 20.9

340
Lounge armchair, technopolymer
shell, steel rod sled frame



810 - 31.9 720 - 28.3

350
Lounge armchair, technopolymer
shell, rocking frame in steel rod
and sled in ash wood



810 - 31.9 825 - 32.5

360
Lounge armchair, technopolymer shell,
die-cast aluminium four-spoke base



810 - 31.9 720 - 28.3

340/3
Upholstered covering only for
technopolymer lounge armchair shell



810 - 31.9

943

Bench multiple seater, technopolymer shell, stainless steel frame



944

Bench multiple seater, technopolymer shell, stainless steel frame



945

Bench multiple seater, technopolymer shell, stainless steel frame

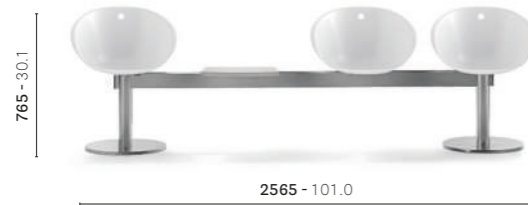

900/A

Armchair, upholstered shell, steel tube frame



904/A

Armchair, upholstered shell, ash wood legs



1020

Armchair, upholstered shell, steel rod sled frame



1040

Armchair, upholstered shell, stainless steel central base



1050

Armchair, upholstered shell, steel central base



930

Armchair, leather shell, steel rod sled frame



904/F

Armchair, leather shell, ash wood legs



940/F

Armchair, leather shell, stainless steel central base



950/F

Armchair, leather shell, steel central base

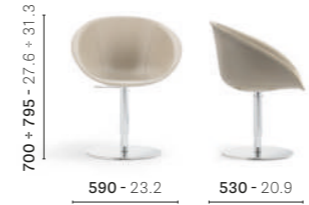

966/2F

Armchair, leather shell, die-cast five-spoke aluminium base with castors



341

Lounge armchair, leather shell, steel rod sled frame



351

Lounge armchair, leather shell, rocking frame in steel rod and sled in ash wood



361

Lounge armchair, leather shell, die-cast aluminium four-spoke base



902
Barstool, polycarbonate shell,
steel rod sled frame



906
Barstool, polycarbonate shell,
steel rod sled frame



970
Barstool, polycarbonate shell,
steel central base



975
Barstool, polycarbonate shell,
stainless steel central base



912
Barstool, upholstered shell,
steel rod sled frame



916
Barstool, upholstered shell,
steel rod sled frame



932
Barstool, leather shell,
steel rod sled frame



936
Barstool, leather shell,
steel rod sled frame



980
Barstool, upholstered shell,
steel central base



985
Barstool, upholstered shell,
stainless steel central base



990
Barstool, leather shell,
steel central base



polycarbonate / policarbonato

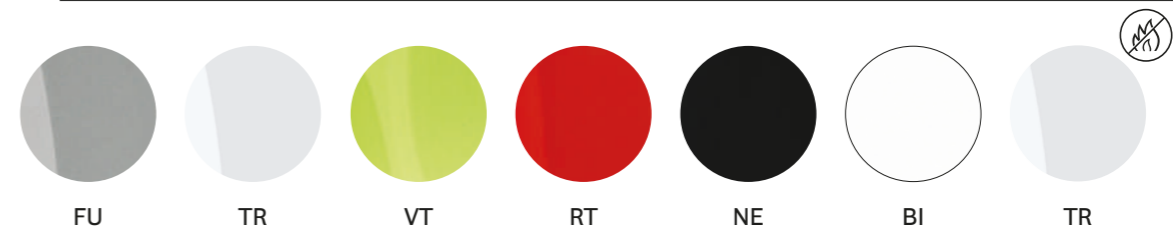

technopolymer / tecnopolimero

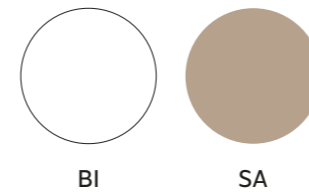

fabrics / tessuti

→ see booklet for finishes
vedi catalogo finiture

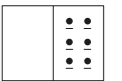

varnished ash / frassino verniciato

lacquered ash with visible grains
frassino laccato a poro aperto

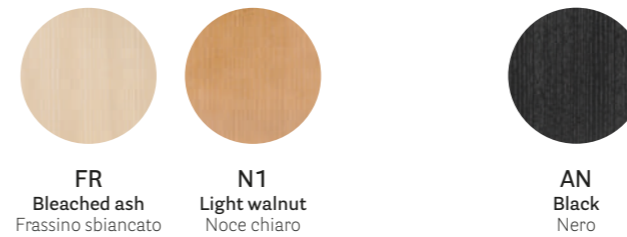

stainless steel / acciaio inox

steel / acciaio

aluminium / alluminio

powder coated / verniciato



→ see booklet for finishes
vedi catalogo finiture

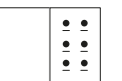

CERTIFICATES / CERTIFICAZIONI

Safety, strength and durability tests / Prove di sicurezza, resistenza e durata
EN 1728:2000 — EN 1022:1998



Nym

The merry chair of Windsor

DESIGN
CMP Design, 2017

EN — Nym is a collection made of solid ash wood which reviews Windsor chairs with a contemporary style. Elliptic profiles feature all the lines enhancing the warmth of wood. The soft versions offer maximum comfort.

IT — Nym è una collezione in massello di frassino che rivisita in chiave contemporanea le sedute Windsor. Profili ellittici corrono lungo tutte le linee esaltando il calore del legno. Le versioni imbottite donano il massimo comfort e accoglienza.



WORKSPACE

Armchair poltrona Nym Soft
Table tavolo Toa Workstation
Lighting lampada Giravolta



WORKSPACE



LIVING



Side chair sedia Nym Soft



Side chair Sedia



Upholstery variable density
Imbottitura a spessore variabile

2882

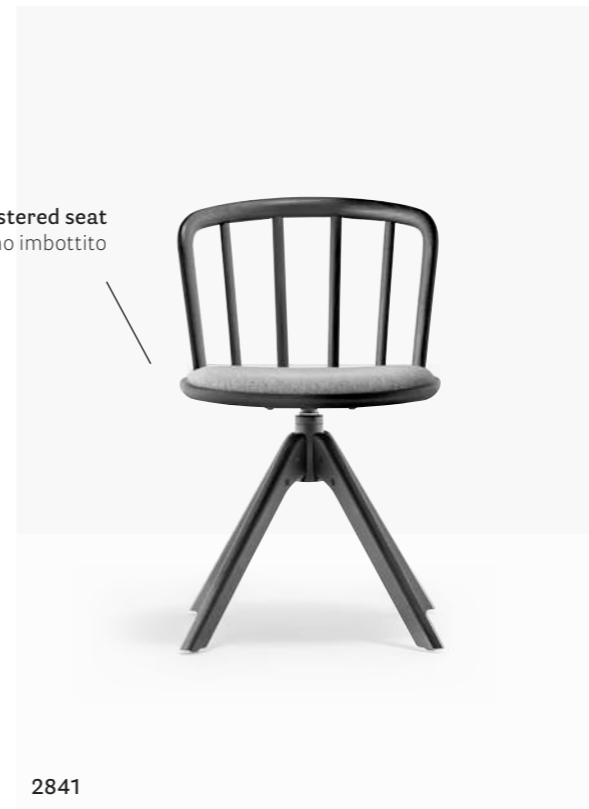

Upholstered seat
Cuscino imbottito

2841



2851

Armchair

Poltrona





Steel rod sled frame
Struttura a slitta
in tondino d'acciaio
Ø 11 mm - 0.43 in

2857



ARKW7_199X79



Die-cast aluminium base
Base in pressofusione
di alluminio

2877

Auc Tahrir Cafeteria - American University

Cairo, Egypt

Project: Educational

Architect: style design architects

Products: Nym barstool, Babila stool



Host 2019

Milan, Italy

Project: Exhibition stand

Architects: CalviBrambilla

Products: Nym armchair,
Modus modular seating,
Elliot table, TO.BE lighting



Workspace Design Show

London, United Kingdom

Project: Exhibition stand
Products: Boxie storage system,
Buddyhub desk, Nym armchair,
Hevea pot-holder

LogHouse by System Logistics

Modena, Italy

Project: Office

Products: Nym Soft armchair,
Stylus table





Pedrali company canteen

Bergamo, Italy

Project: Company
canteen

Architect: Park Associati

Products: Nym Soft
armchair, Blume side
chair, Arki-Table, Hevea
pot-holder



Merchandise Mart Plaza Spec Suite - 5th Floor Spec Suite

Chicago, USA

Project: Office

Architect: Eastlake Studio with BOS

Products: Nym armchair, Folk
barstool

2830
Ash wood side chair



2831
Ash wood side chair, upholstered seat



2850
Ash wood side chair, steel rod sled frame



2851
Ash wood side chair, upholstered seat, steel rod sled frame



2840
Ash wood side chair with trestle legs



2841
Ash wood side chair with trestle legs, upholstered seat



2835
Ash wood armchair



2836
Ash wood armchair, upholstered seat



2855
Ash wood armchair, steel rod sled frame



2856
Ash wood side chair, upholstered seat, steel rod sled frame



2845
Ash wood armchair with trestle legs



2846
Ash wood armchair with trestle legs, upholstered seat



2832
Side chair, upholstered shell ash wood frame



2842
Side chair, upholstered shell with trestle legs



2852
Side chair, upholstered shell, steel rod sled frame



2882
Side chair, upholstered shell, steel tube frame



2837
Armchair, upholstered shell ash wood frame



2847
Armchair, upholstered shell with trestle legs



2857
Armchair, upholstered shell, steel rod sled frame



2887
Armchair, upholstered shell, steel tube frame



2877
Armchair, upholstered shell, die-cast aluminium five-spoke base with castors, adjustable in height



2838
Ash wood barstool



2838/A
Ash wood barstool, upholstered seat



2839
Ash wood barstool



2839/A
Ash wood barstool, upholstered seat



2848
Ash wood barstool with trestle legs



2848/A
Ash wood barstool with trestle legs, upholstered seat



2849
Ash wood barstool with trestle legs



2849/A
Ash wood barstool with trestle legs, upholstered seat



2858
Ash wood barstool, steel rod sled frame



2858/A
Ash wood barstool, upholstered seat, steel rod sled frame



2859
Ash wood barstool, steel rod sled frame



2859/A
Ash wood barstool, upholstered seat, steel rod sled frame



coated ash
frassino verniciato



aluminium
alluminio

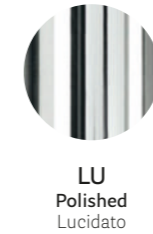

stainless steel
acciaio inox

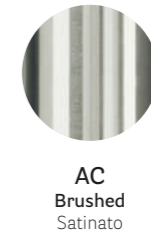

lacquered ash with visible grains / frassino laccato a poro aperto

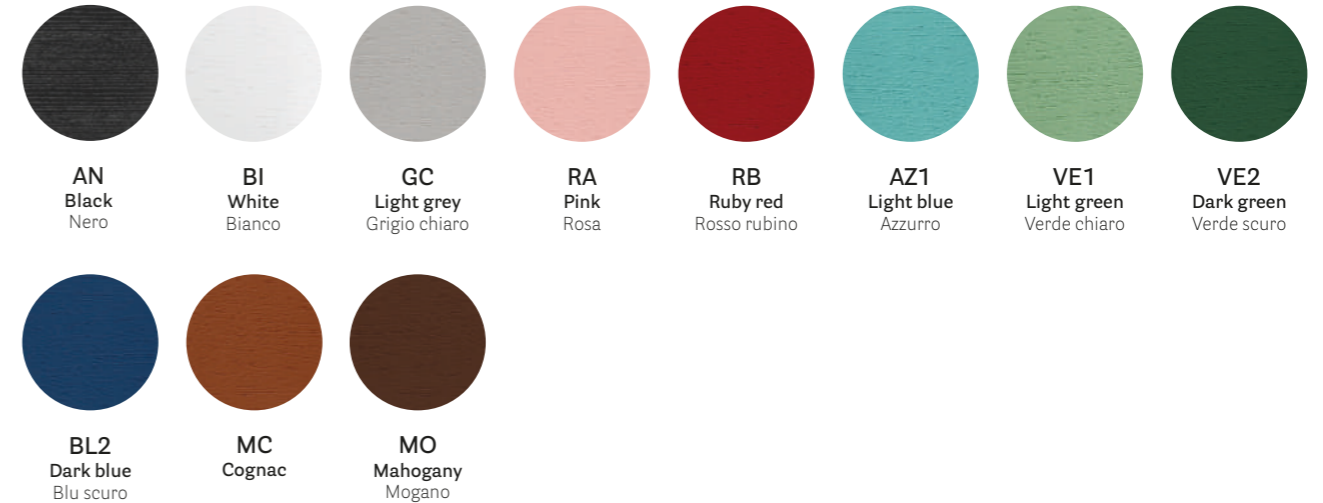

fabrics / tessuti

→ see booklet for finishes
vedi catalogo finiture

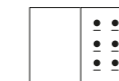

powder coated / verniciato

→ see booklet for finishes
vedi catalogo finiture

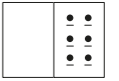

CERTIFICATES / CERTIFICAZIONI

Safety, strength and durability tests / Prove di sicurezza, resistenza e durata
EN 1728:2012+AC2013 — EN 16139:2013 level 2



For
2830 - 2840 - 2850 - 2835
2845 - 2855 - 2838 - 2839
2848 - 2849 - 2858 - 2859

Blume

Flower silhouette

DESIGN
Sebastian Herkner, 2020

EN — Blume draws inspiration from the concepts of elegance and sophistication. Featured by a soft and rounded shape, the collection owes its distinctive appearance to its sophisticated flower-shaped profile in anodised extruded aluminium. An extremely comfortable collection, in which the slender frame and the soft polyurethane foam are combined.

IT — Blume trae ispirazione da un'idea di eleganza e raffinatezza. Una collezione caratterizzata da forme morbide e arrotondate, la cui forza distintiva emerge dal sofisticato profilo in estruso di alluminio anodizzato con una silhouette a forma di fiore. Il telaio prezioso e sottile e la soffice imbottitura in schiumato poliuretano si uniscono rendendo questa collezione assai confortevole.





Side chair sedia Blume



Flower-shaped
extruded aluminium
Estruso di alluminio a
forma di fiore
Ø 19 mm - 0.75 in

Side chair
Sedia



Armchair
Poltrona



Lounge chair

Sedia lounge



Padding in fire-retardant
polyurethane foam
upholstered in fabric
Imbottitura in schiumato
poliuretano ignifugo
rivestita in tessuto

2951



BLTD_89X30 + BLTD_49X37

Lounge armchair

Poltrona lounge



2959



Planet Group Knokke

Knokke-Heist, Belgium

Project: Office

Architect: Buro Project X
Anthony Boelaert

Products: Blume side chair



Pedrali company canteen

Bergamo, Italy

Project: Company canteen

Architect: Park Associati

Products: Blume side chair, Nym Soft armchair,
Arki-Table, L004 lighting, Hevea pot-holder,
Fabbrico table, Volt side chair



IlluMi Spazio Eventi

Milan, Italy

Project: Co-working space

Architect: Barbara Sansonetti

Products: Blume side chair



SIZES / DIMENSIONI

mm - in

2950

Side chair, upholstered seat and back, extruded aluminium frame



2955

Armchair, upholstered seat and back, extruded aluminium frame



2951

Lounge chair, upholstered seat and back, extruded aluminium frame



2959

Lounge armchair, upholstered seat and back, extruded aluminium frame



FINISHES / FINITURE

fabrics / tessuti

→ see booklet for finishes
vedi catalogo finiture

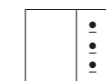

aluminium / alluminio



OA
Antique brass
Ottone anticato

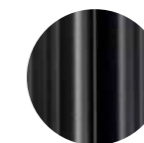

NE
Black / Nero

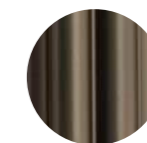

BS
Brushed bronze
Bronzo satinato



GG
Graphite Grey
Grigio Grafite

CERTIFICATES / CERTIFICAZIONI

Safety, strength and durability tests / Prove di sicurezza, resistenza e durata
EN 1728:2012+AC2013 — EN 16139:2013 level 2

AWARDS / PREMI



Blume System

Flower silhouette

DESIGN
Sebastian Herkner, 2022

EN — The set of Blume System is a furnishings that echoes the sophisticated flower-shaped profile in extruded aluminium of the collection with the same name. Available in several sizes, the modules create a variety of configurations. The structure on which the shelves rest is made of steel and is fastened together by means of aluminium castings, with no visible screws.

IT — Blume System è un insieme di complementi d'arredo che riprende il sofisticato profilo in estruso di alluminio della collezione dalla caratteristica silhouette a forma di fiore. I moduli, disponibili in diverse dimensioni, possono dare vita ad una molteplicità di configurazioni. La struttura su cui appoggiano le mensole è realizzata in acciaio ed è fissata attraverso fusioni di alluminio senza viti a vista.



524 / PEDANA / Seating / Sedute

LIVING



Shelving system libreria Blume System

BLUME 525



Shelving system

Sistema di librerie



Profile in extruded aluminium powder-coated in various colours or anodised grey, black, brass or bronze
Profilo in estruso di alluminio verniciato in diversi colori o anodizzato grigio, nero, ottone o bronzo

BLS3_189X32X89

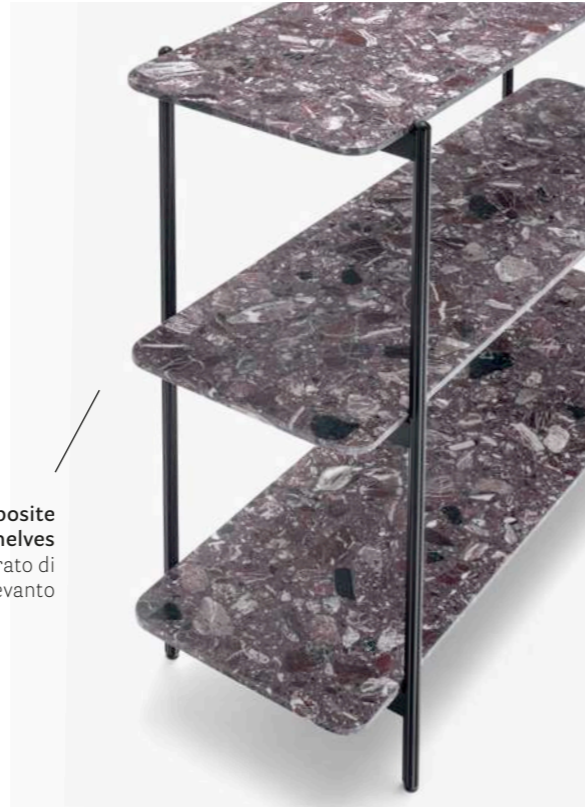

Rosso Levanto composite
marble shelves
Mensole in agglomerato di
marmo Rosso Levanto

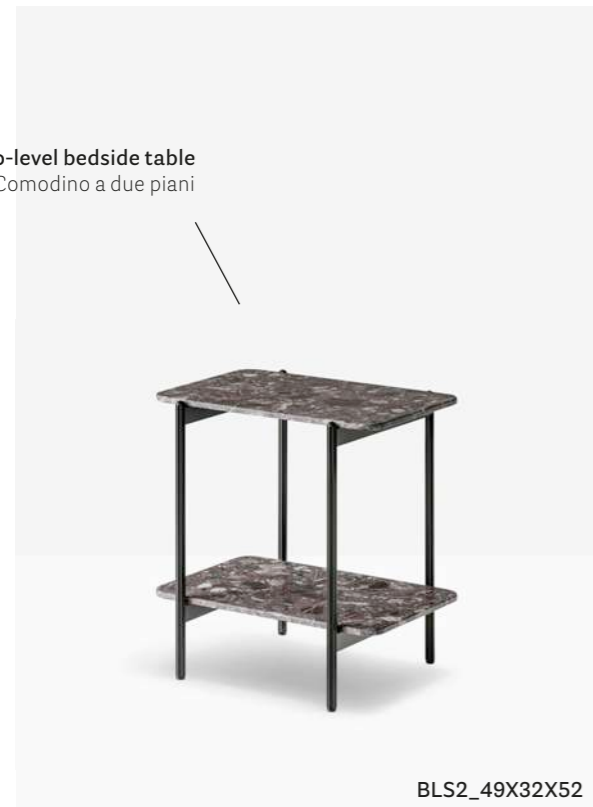

Two-level bedside table
Comodino a due piani

BLS2_49X32X52



BLS3_105X32X89



Flower-shaped extruded
aluminium
Estruso di alluminio
a forma di fiore
Ø 19 mm - 0.75 in

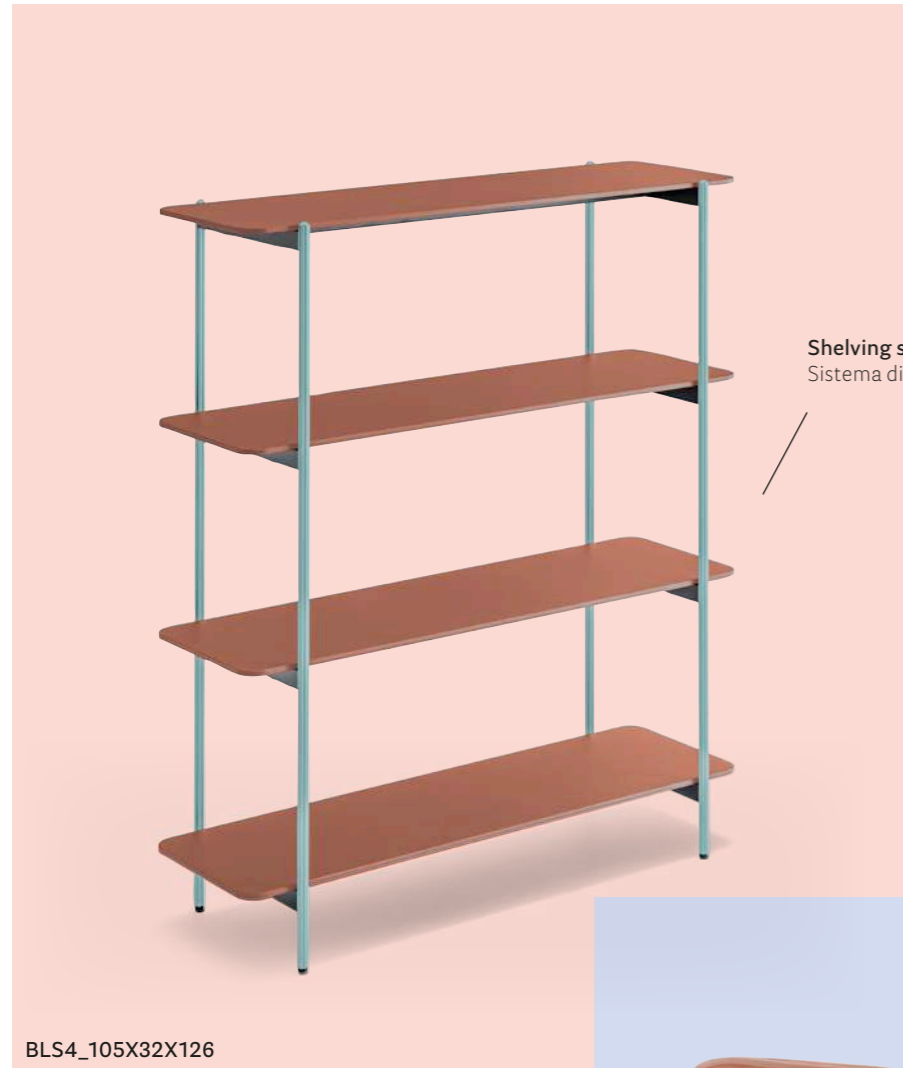

Shelving system
Sistema di librerie

BLS4_105X32X126



2959



#PedraliNewHorizons

Salone del Mobile.Milano 2022
Milan, Italy

Project: Exhibition stand

Architect: CalviBrambilla

Styling: Studio Salaris

Products: Blume shelving system,
coffee table, lounge chair and lounge armchair

BLS2_49X32X52

Two-level bedside table, extruded aluminium frame, composite marble, fenix or solid laminate shelves



BLS3_105X32X89

Three composite marble, fenix or solid laminate shelves, extruded aluminium frame



BLS3_129X32X89

Three composite marble, fenix or solid laminate shelves, extruded aluminium frame



BLS3_189X32X89

Three composite marble, fenix or solid laminate shelves, extruded aluminium frame

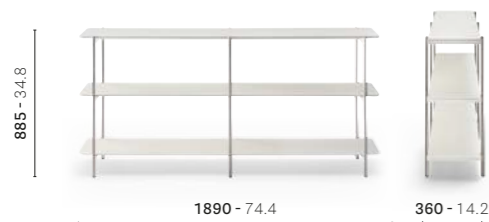

BLS4_105X32X126

Four composite marble, fenix or solid laminate shelves, extruded aluminium frame



BLS4_129X32X126

Four composite marble, fenix or solid laminate shelves, extruded aluminium frame



BLS4_189X32X126

Four composite marble, fenix or solid laminate shelves, extruded aluminium frame



aluminium / alluminio

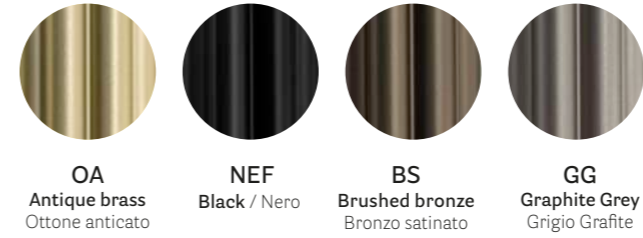

solid laminate top / ripiano in stratificato

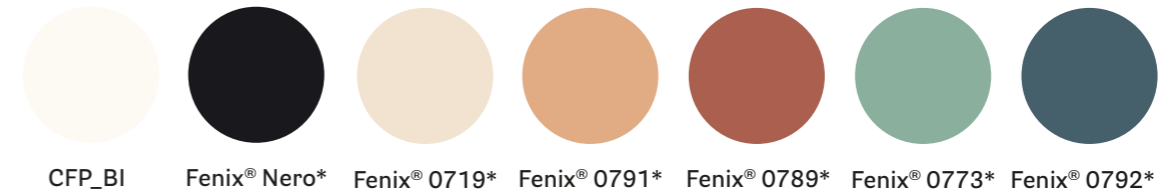

*Anti-fingerprint
Anti-impronta

composite marble top / ripiano in agglomerato di marmo

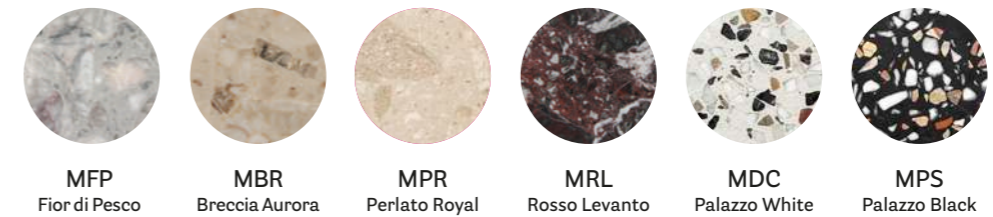

Jazz

Elegant symphonies

DESIGN
Pedrali R&D, 2017

EN — Harmony of shapes, elegance and ergonomics are the main features of the Jazz collection. The seat and the curved backrest are supported by a thin steel frame.

IT — L'armonia delle forme, l'ergonomia e l'eleganza sono le caratteristiche della collezione Jazz. La seduta e lo schienale curvato sono sostenuti da una leggera struttura in acciaio.



Side chair
Sedia

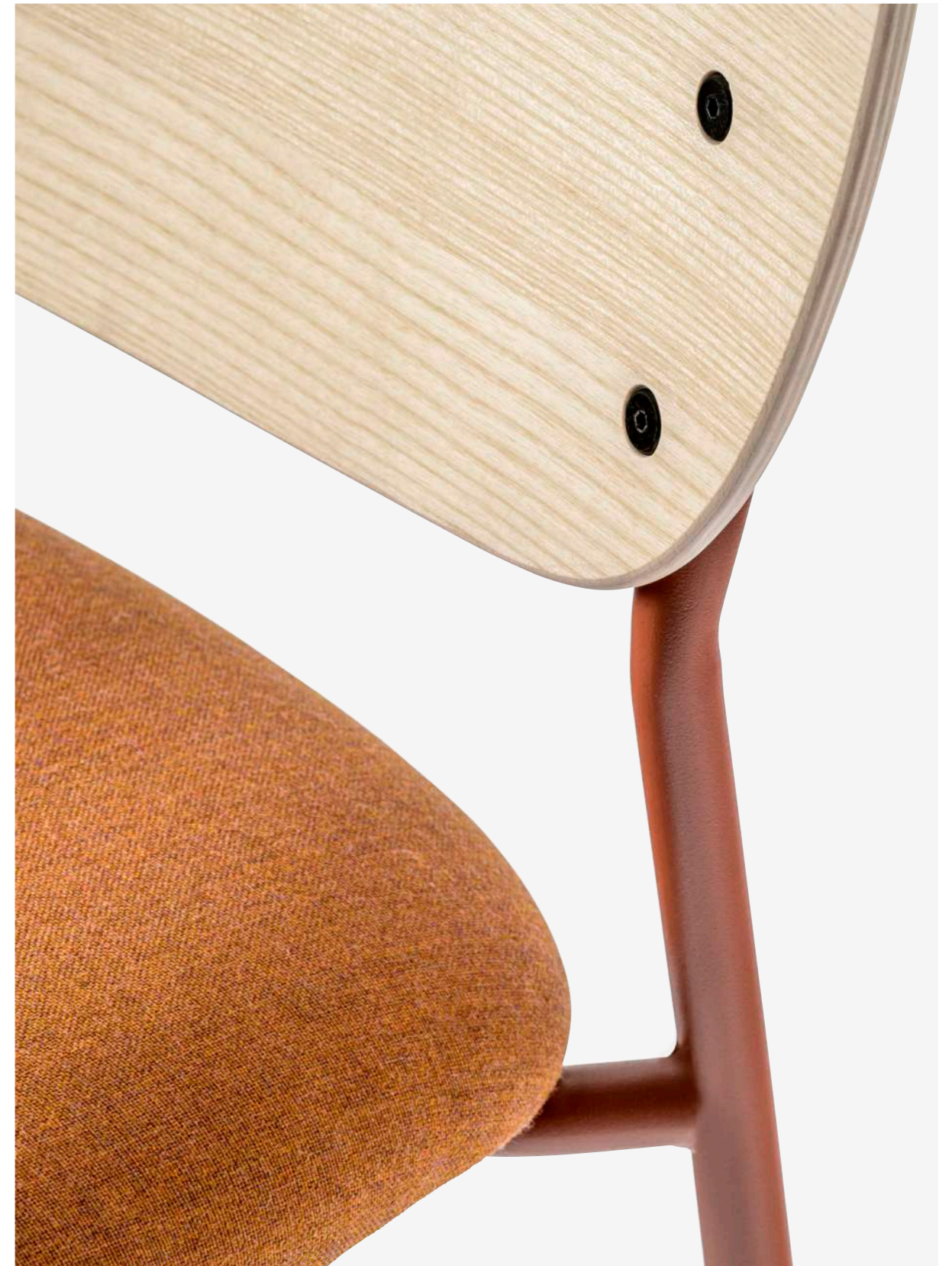

SIDE CHAIR / SEDIA

Stackable
Impilabile



Steel tube frame
Tubo d'acciaio
Ø 16 mm - 0.63 in



3704



3719

Armchair
Poltrona



3716



Upholstery in fabric
or simil-leather
Rivestimento in tessuto
o finta pelle



Steel tube frame
Tubo d'acciaio
Ø 16 mm - 0.63 in



Antique brass finish
Finitura ottone anticato

Barstool

Sgabello

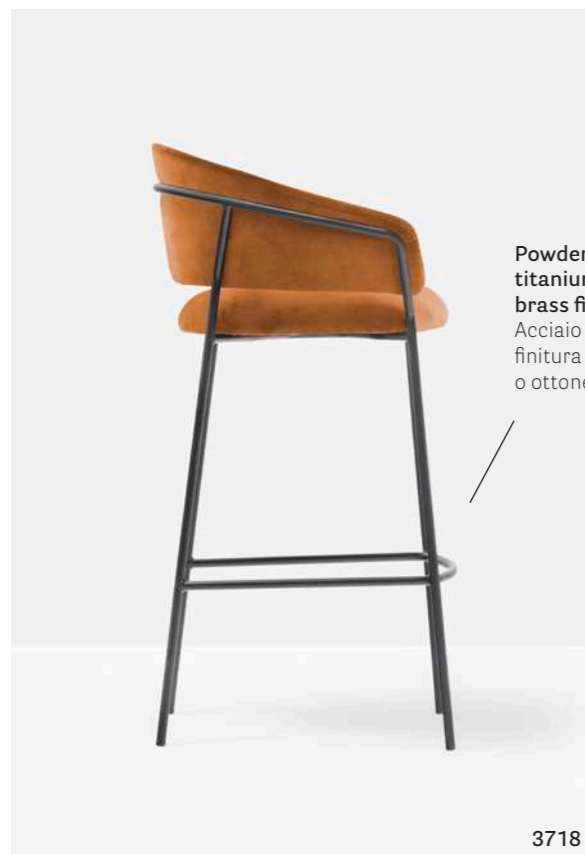

Edelman's Dubai Office

Dubai, UAE

Project: Office

Architect: Roar Design

Products: Jazz barstool,
Arki-Table



Hotel Fourpoints

Milan, Italy

Project: Hotel

Products: Jazz barstool

PULS Vario

Vienna, Austria

Project: Company canteen
Architect: Evolution Design
Products: Jazz armchair and barstool, Inox table



Polestar

Milan, Italy

Project: Office
Architect: Scaglia and Partners
Products: Jazz side chair and barstool

3720
Side chair, upholstered seat and ash plywood back, steel tube frame



3719
Side chair, upholstered seat and back, steel tube frame



3705
Side chair with armrest, upholstered seat and ash plywood back, steel tube frame



3704
Side chair with armrest, upholstered seat and back, steel tube frame



3716
Armchair, upholstered seat and back, steel tube frame



3707
Barstool, upholstered seat and ash plywood back, steel tube frame



3706
Barstool, upholstered seat and back, steel tube frame

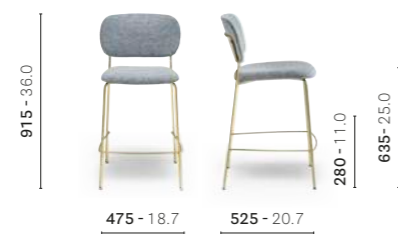

3717
Barstool, upholstered seat and back, steel tube frame



3709
Barstool, upholstered seat and ash plywood back, steel tube frame



3708
Barstool, upholstered seat and back, steel tube frame



3718
Barstool, upholstered seat and back, steel tube frame



gold lacquered / laccato oro



VOR

steel / acciaio

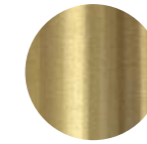

OA
Antique brass
Ottone anticato



TN
Titanium
Titanio

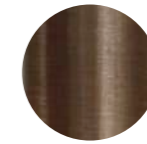

BS
Brushed bronze
Bronzo satinato

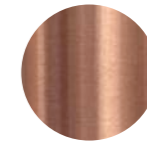

RM
Antique copper
Rame anticato

lacquered ash with visible grains / frassino laccato a poro aperto

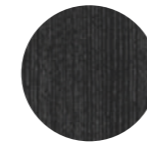

AN
Black
Nero



BI
White
Bianco



GC
Light grey
Grigio chiaro

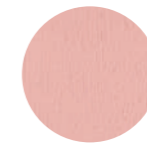

RA
Pink
Rosa



RB
Ruby red
Rosso rubino



MC
Cognac



MO
Mahogany
Mogano

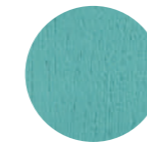

AZ1
Light blue
Azzurro

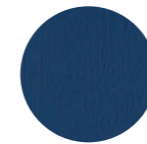

BL2
Dark blue
Blu scuro

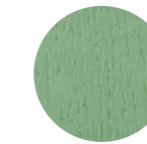

VE1
Light green
Verde chiaro

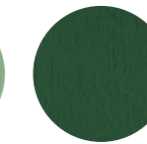

VE2
Dark green
Verde scuro

coated ash / frassino verniciato



FR
Bleached ash
Frassino sbiancato



N1
Light walnut
Noce chiaro

powder coated / verniciato

→ see booklet for finishes
vedi catalogo finiture



fabrics / tessuti

→ see booklet for finishes
vedi catalogo finiture

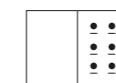

CERTIFICATES / CERTIFICAZIONI

Safety, strength and durability tests / Prove di sicurezza, resistenza e durata
EN 1728:2012+AC2013 — EN 16139:2013 level 2

Vic

Crossover elegance

DESIGN
Patrick Norguet, 2016

EN — Vic family has elegant yet minimal outline and draws inspiration from classic mid-century armchairs. A comfortable and cozy collection featured by a curved backrest raised from the seat, which creates a lightness sensation for chair, armchair and barstool.

IT — La famiglia Vic, elegante e raffinata nella sua semplicità, trae ispirazione dalle classiche poltroncine anni Cinquanta. Una collezione confortevole e accogliente in cui lo schienale a fascia curvata si solleva dal sedile creando un'apertura in grado di conferire a sedia, poltrona e sgabello una sensazione di leggerezza.

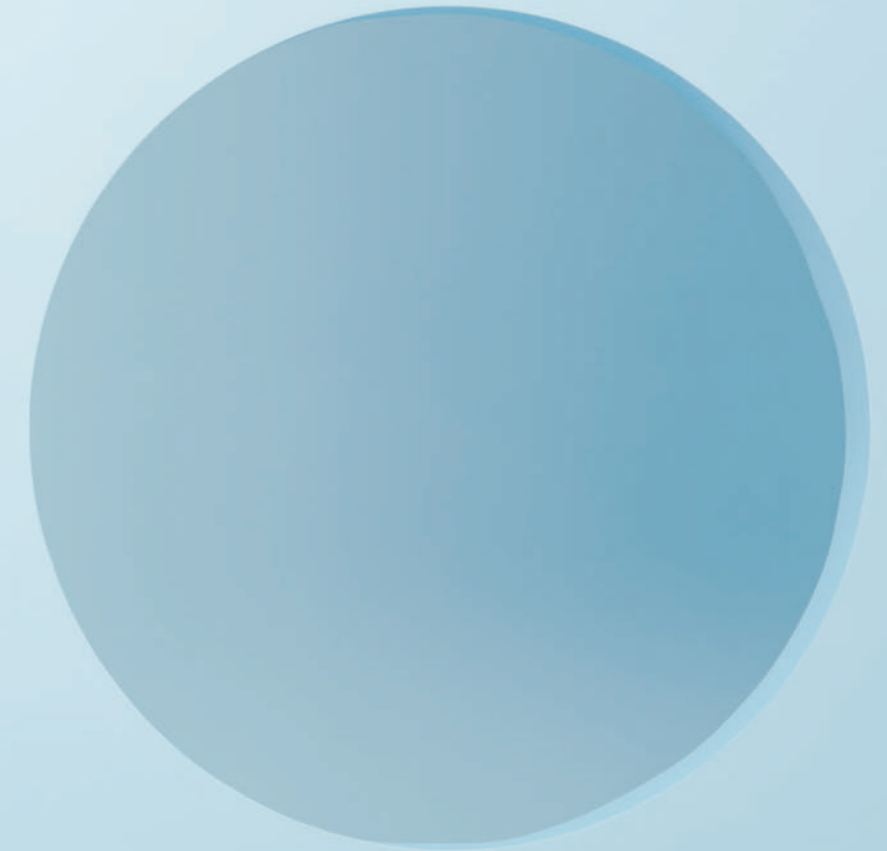



Desktop Panel pannello divisorio da tavolo Toa Folding Screen
Table tavolo Toa
Side chair sedia Vic
Lighting lampada Tamara



655



656

Steel tube legs titanium finish
Gambe in acciaio finitura in titanio

Side chair Sedia



Armchair

Poltrona



ARMCHAIR / POLTRONA

Steel tube legs
and upholstered, leather
or simil-leather shell
below cover
Gambe in tubo d'acciaio
e guscio sottoscocca
rivestito in tessuto,
vera o finta pelle



646



TAE_220X106

Seat height
Altezza seduta
750 mm - 29.5 in



648

Seat height
Altezza seduta
650 mm - 25.6 in



649

Barstool
Sgabello



659

Steel tube frame
Struttura in
tubo d'acciaio
Ø 25 mm - 0.98 in

Hotel Villa Soligo

Treviso, Italy

Project: Hotel

Products: Vic Metal armchair

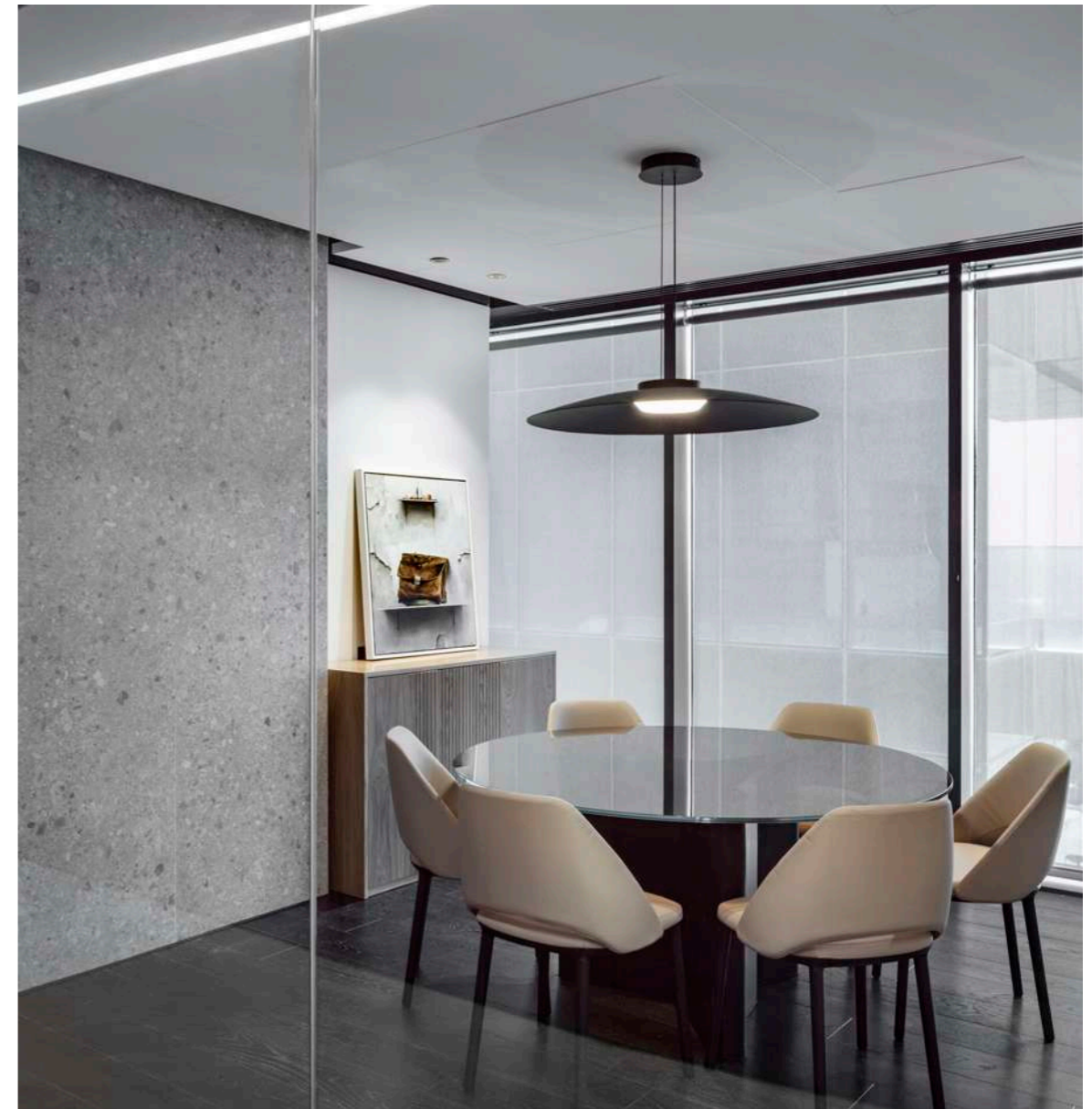
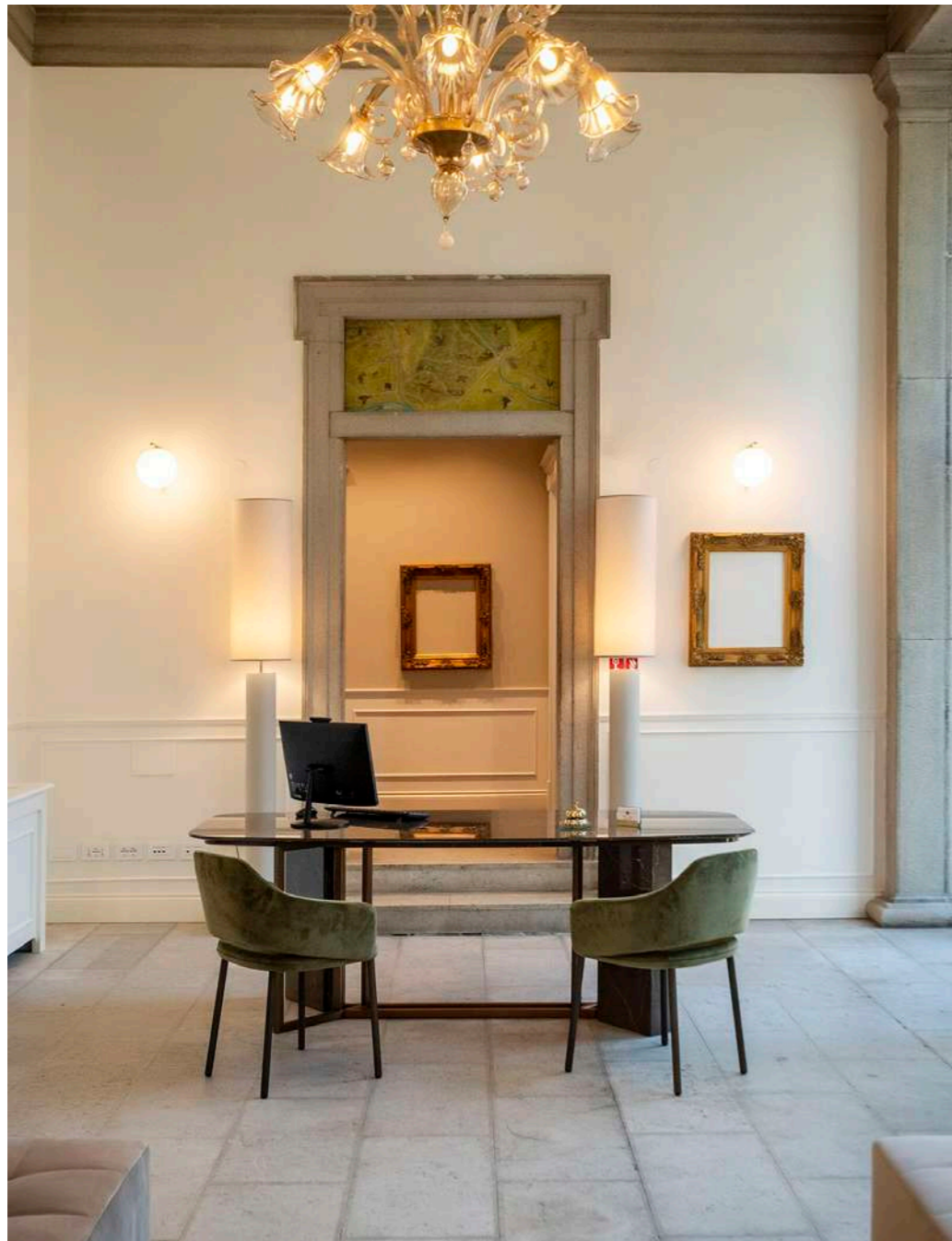

Fortissimo Headquarters

Tel Aviv, Israel

Project: Headquarters

Architect: Alter architects

Products: Vic side chair



De Sol Hotel & SPA

Santorini, Greece

Project: Hotel

Products: Vic Metal armchair, Inox table,
Babila barstool, Nemea armchair,
Modus modular seating



Porsche Experience Center

Brescia, Italy

Project: Restaurant

Architect: gbpaarchitects

Products: Vic side chair, Arki-Base
table, Nemea side chair, Malmö
coffee table, Elliot table, Tweet side
chair, Ypsilon Tilting table, Remind
armchair, Reva armchair and sofa



SIZES / DIMENSIONI

655

Side chair, upholstered seat and backrest, black ABS shell below cover, ash wood legs



656 - 657

Side chair, upholstered seat and backrest, upholstered or black ABS shell below cover, steel tube legs



645

Armchair, upholstered seat and backrest, black ABS shell below cover, ash wood legs



646 - 647

Armchair, upholstered seat and backrest, upholstered or black ABS shell below cover, steel tube legs



658 - 658/2

Barstool, upholstered seat and backrest, upholstered or black ABS shell below cover, steel tube legs



659 - 659/2

Barstool, upholstered seat and backrest, upholstered or black ABS shell below cover, steel tube legs



648 - 648/2

Barstool, upholstered seat and backrest, upholstered or black ABS shell below cover, steel tube legs



649 - 649/2

Barstool, upholstered seat and backrest, upholstered or black ABS shell below cover, steel tube legs



FINISHES / FINITURE

fabrics / tessuti

→ see booklet for finishes
vedi catalogo finiture

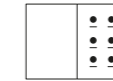

lacquered ash with visible grains
frassino laccato a poro aperto

coated ash
frassino verniciato

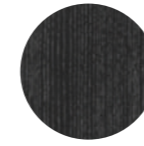

AN
Black
Nero



GC
Light grey
Grigio chiaro



FR
Bleached ash
Frassino sbiancato



N1
Light walnut
Noce chiaro

abs shell below cover
guscio sottoscocca in abs

steel
acciaio

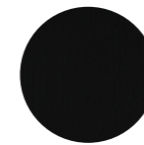

NE



ST
Satinized
Satinato

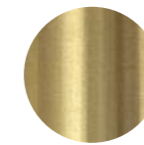

OA
Antique brass
Ottone anticato

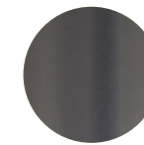

TN
Titanium
Titanio

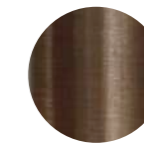

BS
Brushed bronze
Bronzo satinato

powder coated / verniciato

→ see booklet for finishes
vedi catalogo finiture

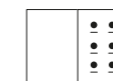

CERTIFICATES / CERTIFICAZIONI

Safety, strength and durability tests / Prove di sicurezza, resistenza e durata
EN 1728:2012+AC2013 — EN 16139:2013 level 2



Ila

L'île du confort

DESIGN
Patrick Jouin, 2020

EN — The elegant and high-quality Ila armchair is a refined piece of furniture with a strong personality, expressing utmost comfort, softness and sensuality. The smooth exterior in rigid polyurethane almost cocoons the user in its large volumes, allowing a moment of relaxation and escape from everyday life. This sense of protection is augmented by the inner side of the backrest and seat in flexible polyurethane foam, which adapts to the human body and envelops it just like a soft embrace.

IT — Ila sintetizza i concetti di eleganza e qualità, identificandosi come un arredo prezioso dalla forte personalità capace di esprimere comfort assoluto, morbidezza e sensualità. La parte esterna di Ila è realizzata in poliuretano rigido, liscio e teso, quasi a creare una protezione nei confronti di chi ha scelto di ritagliarsi un momento di relax e di evasione, all'interno dei suoi grandi volumi. Il senso di protezione viene inoltre suggerito dalla parte interna di schienale e sedile, a contatto con il corpo umano, in schiumato poliuretano flessibile, quasi a cingerlo in un abbraccio.



Lounge armchair poltrona lounge Ila



Lounge armchair

Poltrona lounge

Version with headrest
Versione con poggiatesta

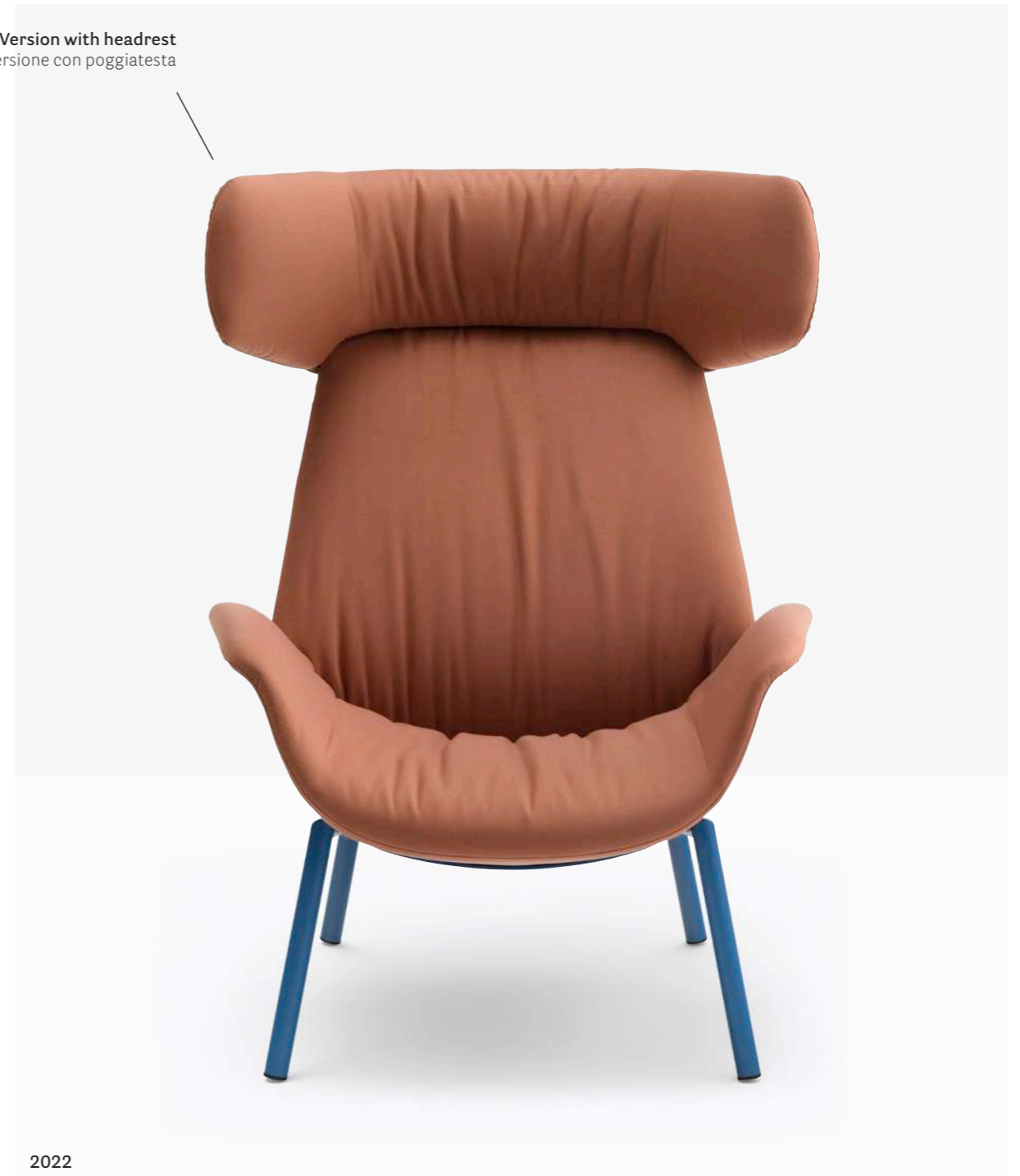

2022



2024



Fabric cover for the inner side and leather for the exterior
Rivestimento interno in tessuto ed esterno in pelle



2020

Central steel base in the shape of a cone section
Base centrale a tronco di cono in acciaio



2021

Version without headrest
Versione senza poggiatesta



Solid ash wood frame
Telaio in massello di frassino
Ø 40 mm - 1.57 in



Metal tubular
frame
Telaio in tubo
metallico
Ø 30 mm - 1.18 in

2023



CRTD_59X25



Armofer padiglione culturale ricreativo

Sizzano, Italy

Project: Educational

Architect: fabiogianoliinteriordesigner

Products: Ila lounge armchair,
Babila Comfort lounge armchair,
Malmö Relax lounge armchair,
Blume coffee table, Code coffee table

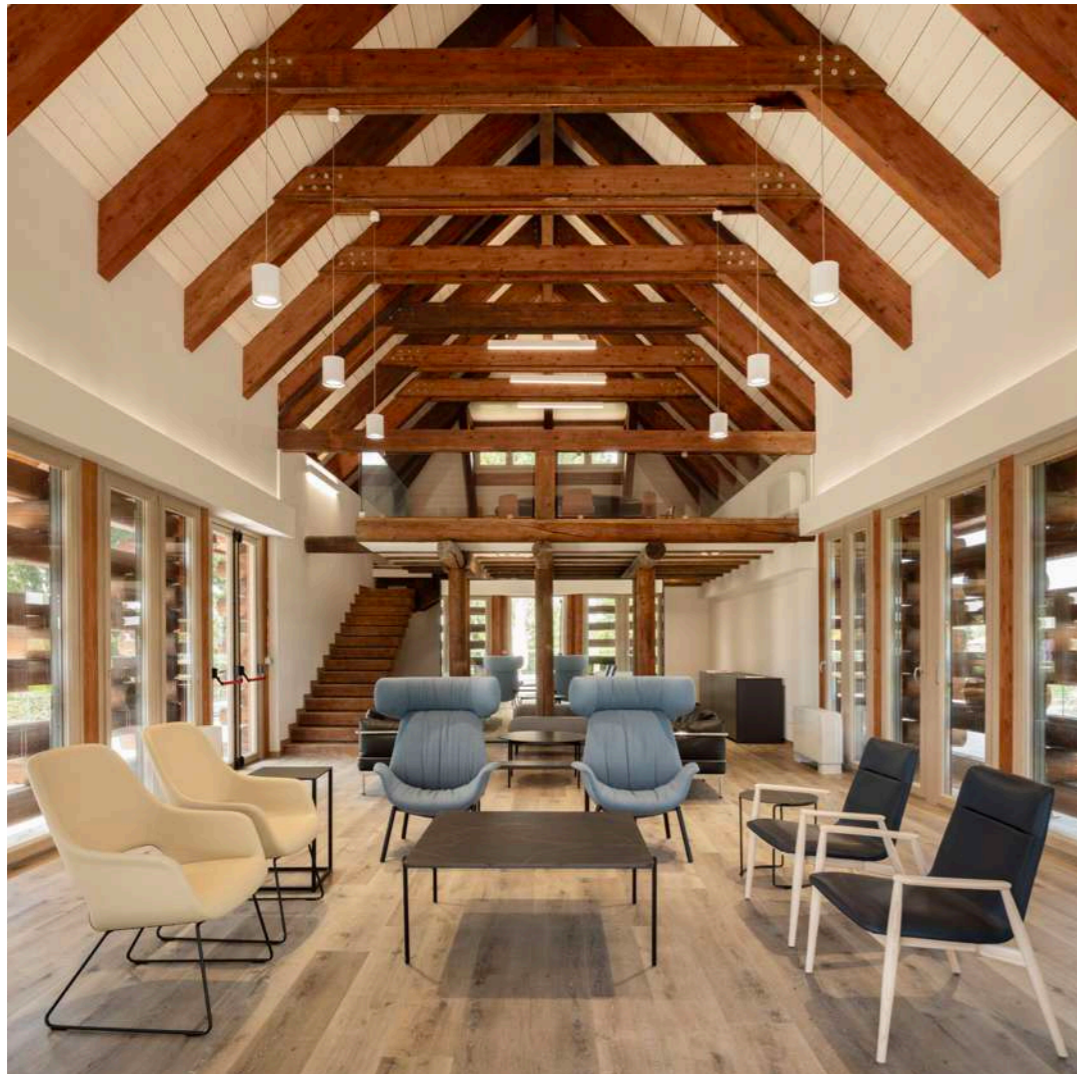

#pedralitales

Antwerp, Belgium

Project: 2021 ADV campaign

Products: Ila lounge armchair,
Circuit coffee table, L001 lighting



#PedraliNewHorizons

Salone del Mobile.Milano 2022
Milan, Italy

Project: Exhibition stand

Architect: CalviBrambilla

Styling: Studio Salaris

Products: Ila lounge armchair,
Malmö coffee table, Hevea pot-holder, Jeff sofa



Tronios Almelo Head Office

Almelo, Netherlands

Project: Company canteen

Architect: Remy Meijers
Interieurarchitectuur

Products: Ila lounge armchair,
Babila XL armchair, Jamaica side chair



2020

Lounge armchair with headrest, upholstered shell, conical steel base



2021

Lounge armchair, upholstered shell, conical steel base



2022

Lounge armchair with headrest, upholstered shell, steel tube frame



2023

Lounge armchair, upholstered shell, steel tube frame



2024

Lounge armchair with headrest, upholstered shell, solid ash wood frame



2025

Lounge armchair, upholstered shell, solid ash wood frame



fabrics / tessuti

→ see booklet for finishes
vedi catalogo finiture

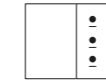

coated ash / frassino verniciato



FR
Bleached ash
Frassino sbiancato

N1
Light walnut
Noce chiaro

lacquered ash with visible grains / frassino laccato a poro aperto

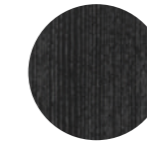

AN
Black
Nero

steel / acciaio



TN
Titanium
Titanio

powder coated / verniciato

→ see booklet for finishes
vedi catalogo finiture

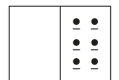

CERTIFICATES / CERTIFICAZIONI

Safety, strength and durability tests / Prove di sicurezza, resistenza e durata
EN 1728:2012+AC2013 — EN 16139:2013 level 2



AWARDS / PREMI



BIGSEE
PRODUCT DESIGN
AWARD 2022
WINNER

Matrix

Lightweight spirit

DESIGN
Claudio Dondoli - Marco Pocci, 2006

EN — Matrix is a collection of tables, desks and consoles with simple and basic lines, light structures but of great solidity. A panel, which is upholstered in fabric, serves as space divider and completes the desk.

IT — Matrix è una collezione di tavoli, scrivanie e consolle dalle linee semplici ed essenziali, strutture lievi all'apparenza ma di grande solidità.

La scrivania può essere completata con schermi divisori rivestiti in tessuto per la definizione e la separazione dello spazio.



Table
Tavolo

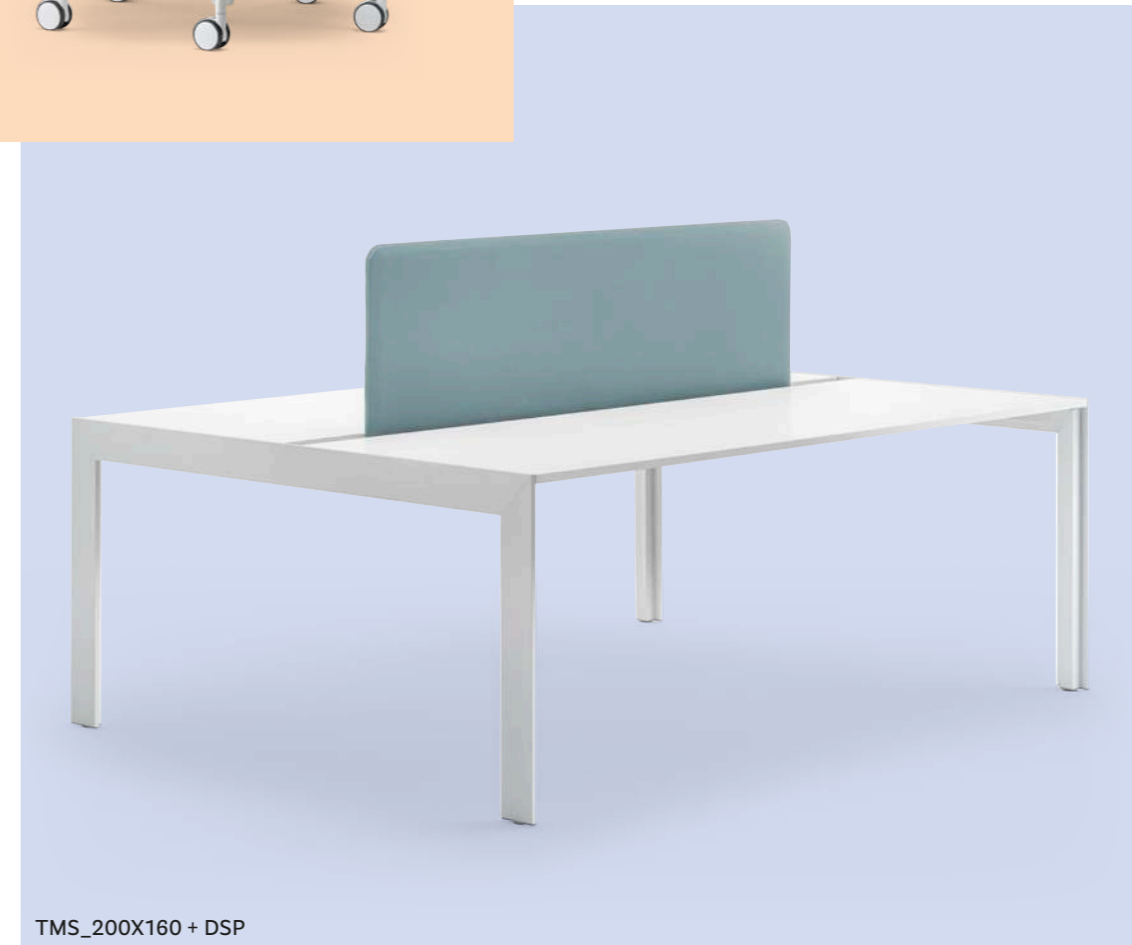

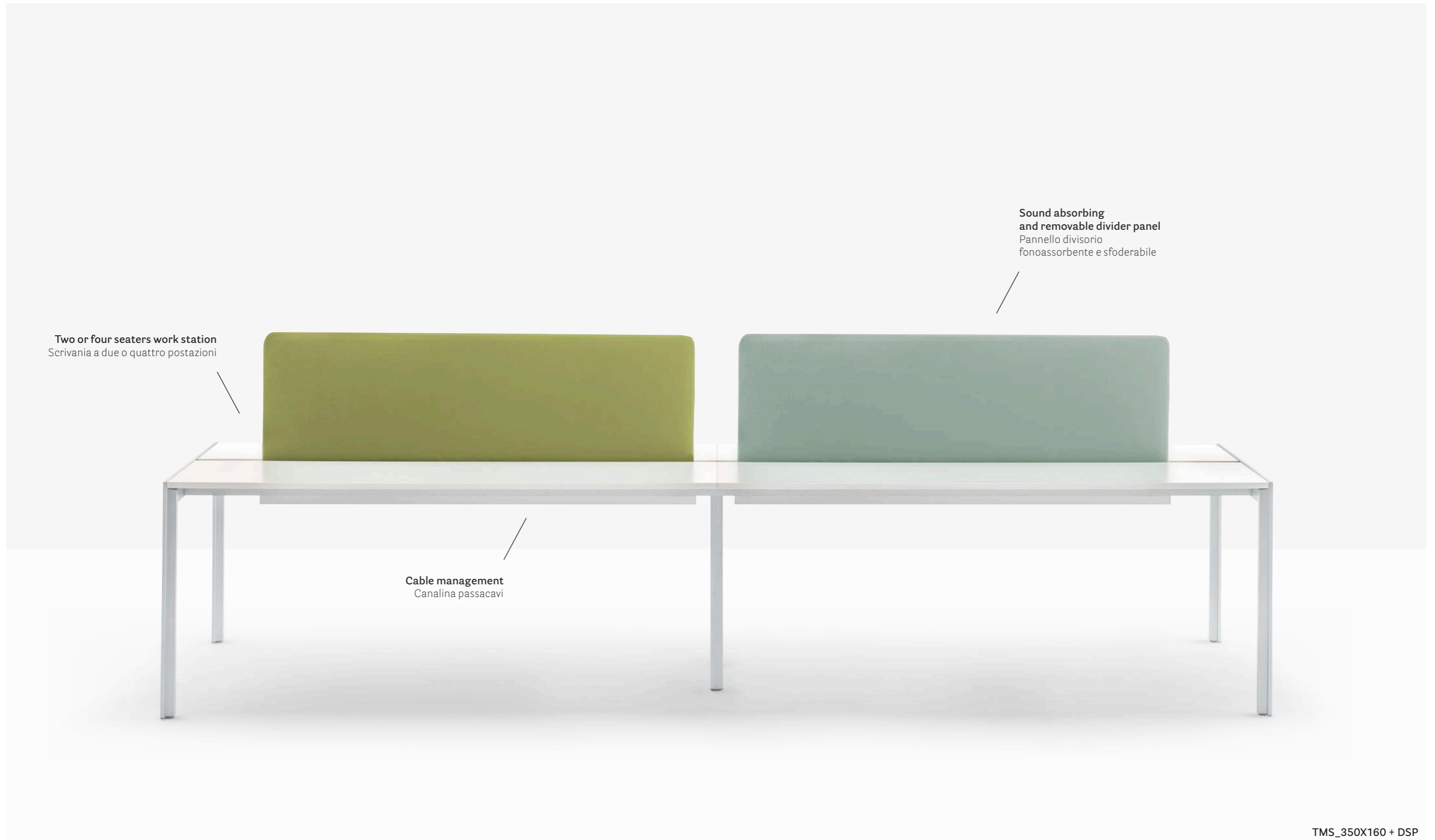

Two or four seaters work station
Scrivania a due o quattro postazioni

Cable management
Canalina passacavi

Sound absorbing
and removable divider panel
Pannello divisorio
fonoassorbente e sfoderabile

TMS_350X160 + DSP

First Floor

Roè Volciano
Brescia, Italy

Project: Office

Products: Matrix desk with
divider sound absorbing panel,
Noa armchair



Private House

Brescia, Italy

Project: Private house

Products: Matrix table with
extension, white glass top,
Enjoy chair

TMA_88X86

Extensible table, aluminium frame, laminate top



TMA_130X86

Extensible table, aluminium frame, glass or laminate top



TMA_165X86

Extensible table, aluminium frame, glass or laminate top



TMF_86X86

Fixed table, aluminium frame, glass top



TMF_200X86

Fixed table, aluminium frame, glass top



TMC_160X50

Extensible Consolle, aluminium frame, glass top

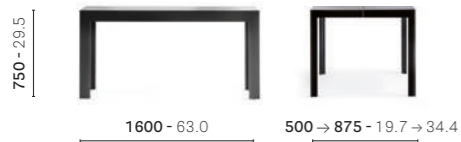

TMD_200X86

Fixed table, aluminium frame and solid laminate top



TMS_200X160

2 Work station, aluminium frame, laminate top, setting for divider panel, single cable management (1500x150 - 59.1x5.9)



TMS_350X160

4 Work station, aluminium frame, laminate top, setting for divider panel, double cable management (1500x150 - 59.1x5.9)



DSP

Sound absorbing divider panel



DSP/2

Sound absorbing divider panel



CC/DSP

Cable management only



FINISHES / FINITURE

laminate top

ripiano in laminato



406_0020 527 312

solid laminate

ripiano in stratificato



CFC_BI

lacquered glass top

ripiano in vetro laccato

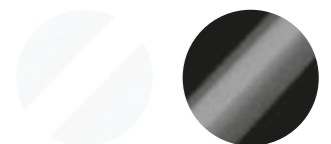

BIA NER

aluminium frame

telaio in alluminio



AA

powder coated aluminium frame

telaio in alluminio verniciato



BI NERO

divider panel fabrics

tessuti pannello divisorio

→ see booklet for finishes
vedi catalogo finiture

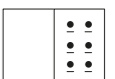

Inga

Sinuuous elegance

DESIGN
Pedrali R&D, 2014

EN — Inga name pays tribute to the Northern European female elegance. The plywood shell in oak veneered has sinuous shapes. The Soft version outlines gentle and essential lines thanks to the padded shell and armrests.

IT — Inga deve il suo nome all'eleganza femminile nord-Europea. La scocca, realizzata in multistrato da tranciato di rovere, ha una forma morbida e sinuosa. La versione Soft presenta scocca e braccioli imbottiti, sottolineandone ulteriormente le linee dolci ed essenziali.



Side chair Sedia



5613

SIDE CHAIR / SEDIA



SIDE CHAIR / SEDIA



Genuine or regenerated leather shell, matching stitches
Scocca in cuoio naturale o rigenerato con cuciture in tinta

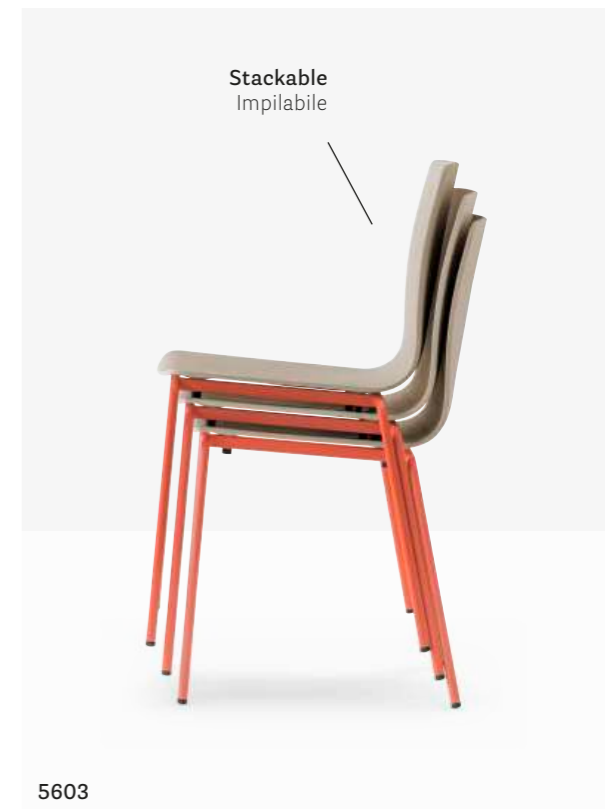

Armchair

Poltrona



Lounge chair

Seduta lounge



Barstool

Sgabello





Remai Modern

Saskatoon, Canada

Project: Museum

Architects: KPMB

Architects,
Architecture 49

Products: Inga side chair
and barstool, Laja table





Chromavis Fareva New Headquarter

Offanengo, Italy

Project: Office and
company canteen

Architect: EBA Engineering

Interior Design: DL arredi

Products: Inga side chair,
Arki-Table, L001 lighting



SIZES / DIMENSIONI

mm - in

5603

Side chair, technopolymer
shell, steel tube frame



5604

Armchair, technopolymer shell,
steel tube frame



5609

Side chair, technopolymer shell,
steel rod sled frame



5613

Side chair, plywood shell,
steel tube frame



5614

Armchair, plywood shell,
steel tube frame



5619

Side chair, plywood shell,
steel rod sled frame



5616

Barstool, plywood shell,
steel tube frame



5617

Barstool, plywood shell,
steel tube frame

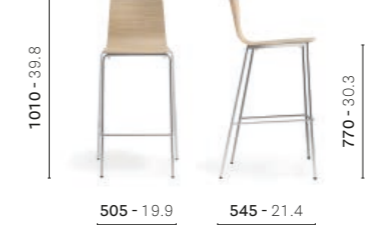

5663

Side chair, leather shell,
steel tube frame



5664

Armchair, leather shell,
steel tube frame



5669 *

Side chair, leather shell,
steel rod sled frame



SIZES / DIMENSIONI

mm - in

5683 *

Side chair, upholstered shell,
steel tube frame



5684 *

Armchair, upholstered shell,
steel tube frame



5685 *

Armchair, upholstered shell
and armrests, steel tube frame



5689 *

Side chair, upholstered shell,
steel rod sled frame



5686

Barstool, upholstered shell,
steel tube frame



5687

Barstool, upholstered shell,
steel tube frame



5681

Lounge chair, upholstered shell,
steel tube frame



5688

Lounge chair, upholstered shell,
steel rod sled frame



FINISHES / FINITURE

coated oak
rovere verniciato



RS
Bleached oak
Rovere sbiancato



W
Wenge
Wengé

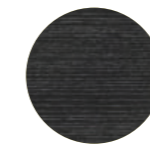

AN
Black
Nero

lacquered oak with visible grains
rovere laccato a poro aperto

coated oak vintage finishes
rovere verniciato anticato



V101



V102



V103

technopolymer / tecnopolimero

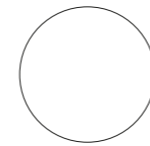

BI



RA2



SA

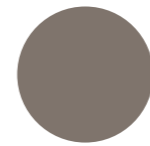

GR

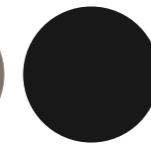

NE

fabrics / tessuti

→ see booklet for finishes
vedi catalogo finiture

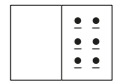

steel / acciaio



CR
Chromed
Cromato

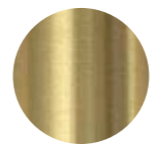

OA
Antique brass
Ottone anticato

powder coated / verniciato

→ see booklet for finishes
vedi catalogo finiture

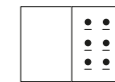

CERTIFICATES / CERTIFICAZIONI

Safety, strength and durability tests / Prove di sicurezza, resistenza e durata
EN 1728:2012+AC2013 — EN 16139:2013 level 2



For
5613 - 5614
5616 - 5617

* stackable with panel, on request / impilabile con pannello, a richiesta

Malmö

Nordic essence

DESIGN
CMP Design, 2012

EN — Malmö chairs are designed to fit in convivial spaces and they evoke warmth sensations thanks to the touch of ash wood, the tapered look and the appeal of tradition. Malmö collection consists of a plywood shell in ash wood that appears suspended, nearly floating, on a solid wood frame. The design elements appear in their purity, thicker in the joints and tapered in a natural way to offer lightness and elegance.

IT — Le sedute Malmö, pensate per essere usate in luoghi di convivialità, esprimono un tepore domestico grazie al piacere tattile del frassino, l'espressività delle forme tornite, l'affinità con un immaginario tradizionale. La collezione Malmö è costituita da una scocca in multistrato di frassino che appare sospesa, quasi fluttuante, su un telaio in legno massello. Gli elementi strutturali appaiono nella loro pura costruzione, aumentando di spessore presso le connessioni ed affusolandosi in modo naturale a favorire leggerezza ed eleganza.



Table tavolo Malmö
Side chair sedia Malmö
Armchair poltrona Malmö





Side chair
Sedia



Upholstered shell,
fabric covering
Scocca imbottita
rivestita in tessuto



Stackable
Impilabile



Armchair Poltrona

Ash veneered
plywood shell
Scocca in multistrato
di frassino impiallacciato





**Upholstered shell,
fabric covering**
Scocca imbottita
rivestita in tessuto

**Solid ash wood
frame and armrests**
Struttura e braccioli
in massello di frassino

396

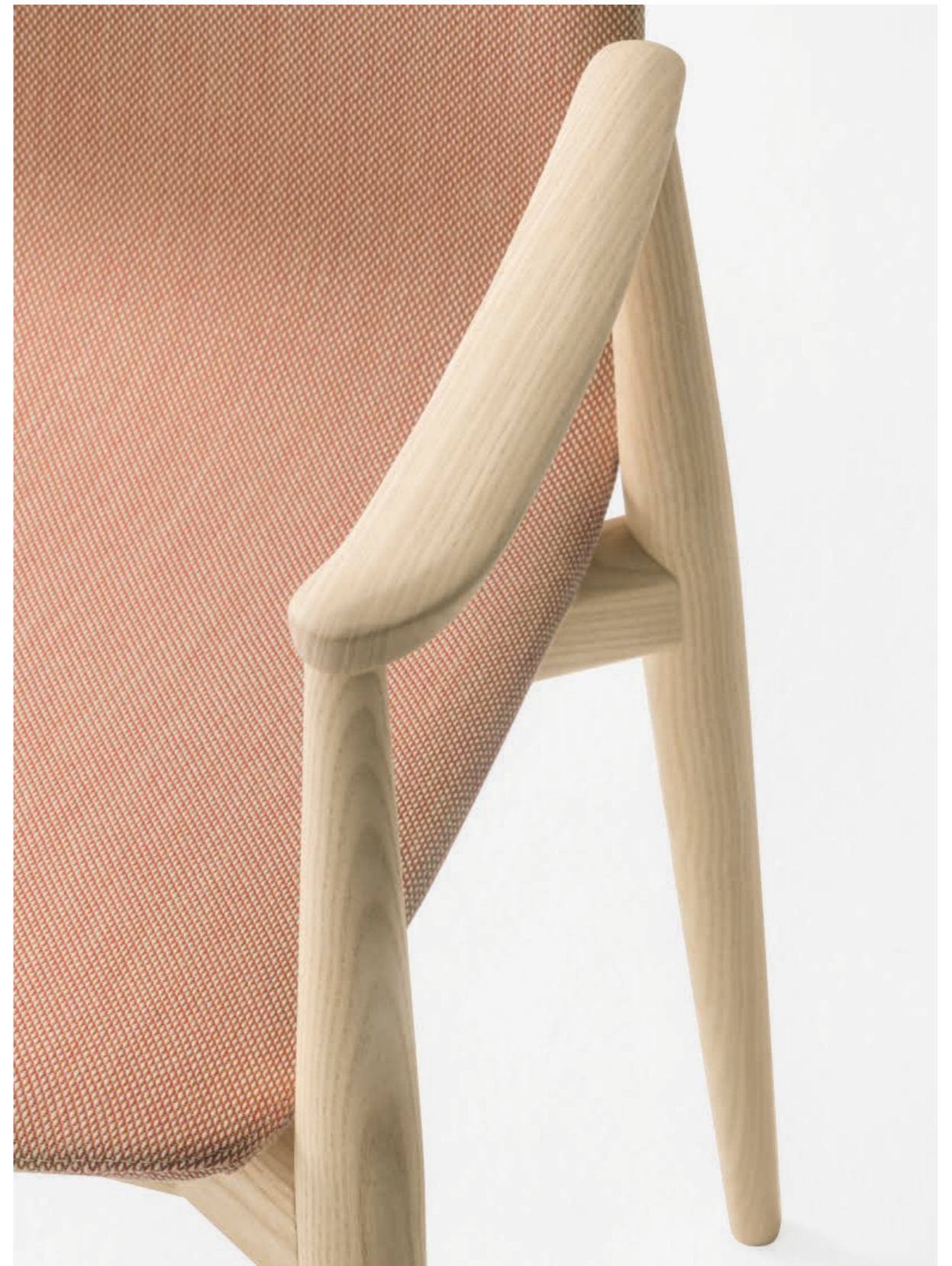

Lounge armchair

Poltrona lounge



Barstool

Sgabello



Solid ash frame and stainless steel footrest
Struttura in massello di frassino e poggiatesta in acciaio inox satinato

246

Table

Tavolo

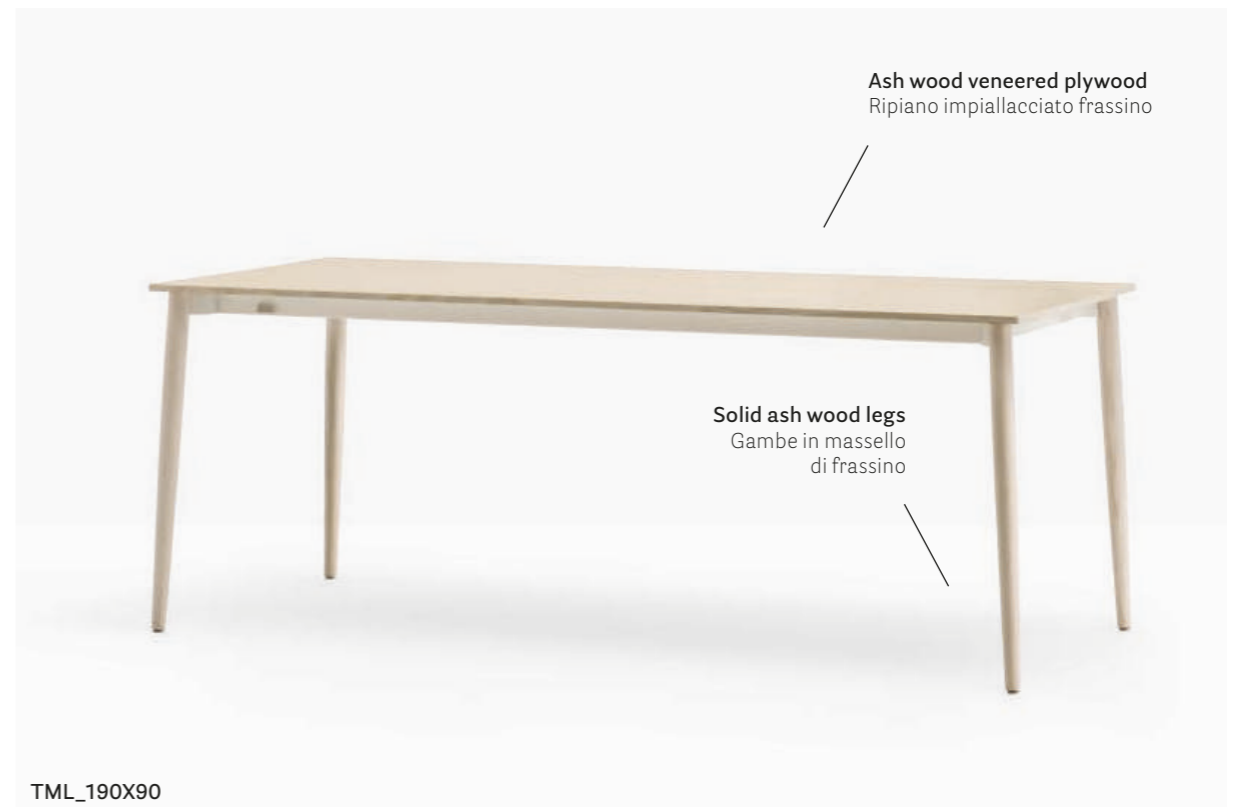

Ash wood veneered plywood
Ripiano impiallacciato frassino

Solid ash wood legs
Gambe in massello di frassino

TML_190X90

Extensible table
Tavolo allungabile
1900→2400→2900 x 900 mm
74.8→94.5→114.2 x 35.4 in

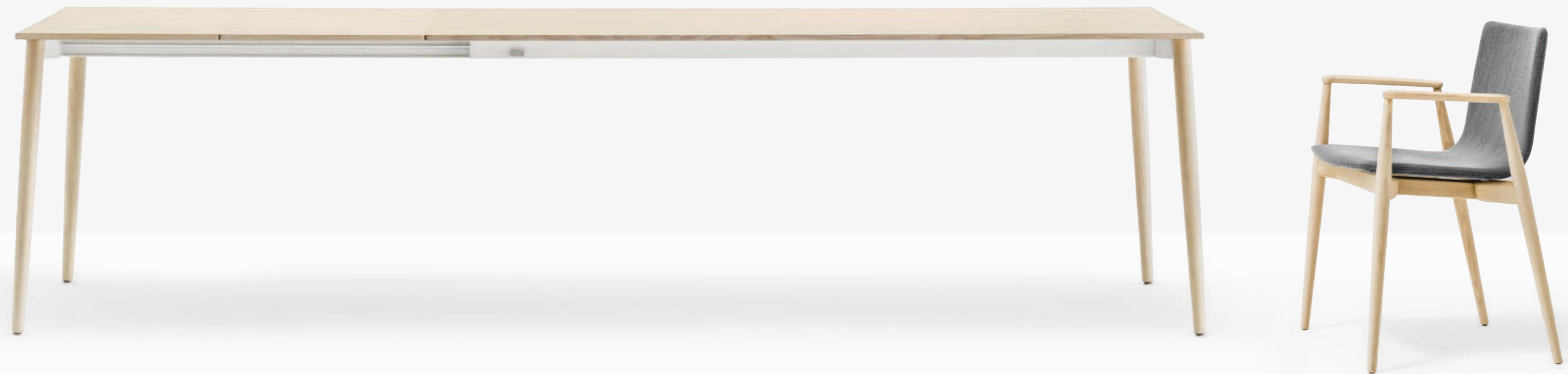

TML_190X90 + 396



Fort McMurray International Airport

Alberta, Canada

Project: Waiting area

Architects: office of mcfarlane biggar
architects + designers

Product: Malmö barstool



Microsoft House

Milan, Italy

Project: Office

Architects: Herzog & de Meuron (building architecture), DEGW - brand of Lombardini22 (Interior Design & Space Planning)

Products: Malmö side chair, Volt side chair, Modus modular seating, Arki-Base table, Happy Apple lighting



Microsoft Office

Lisbon, Portugal

Project: Office

Architect: OPENBOOK Architecture

Products: Malmö lounge armchair, Buddy pouf

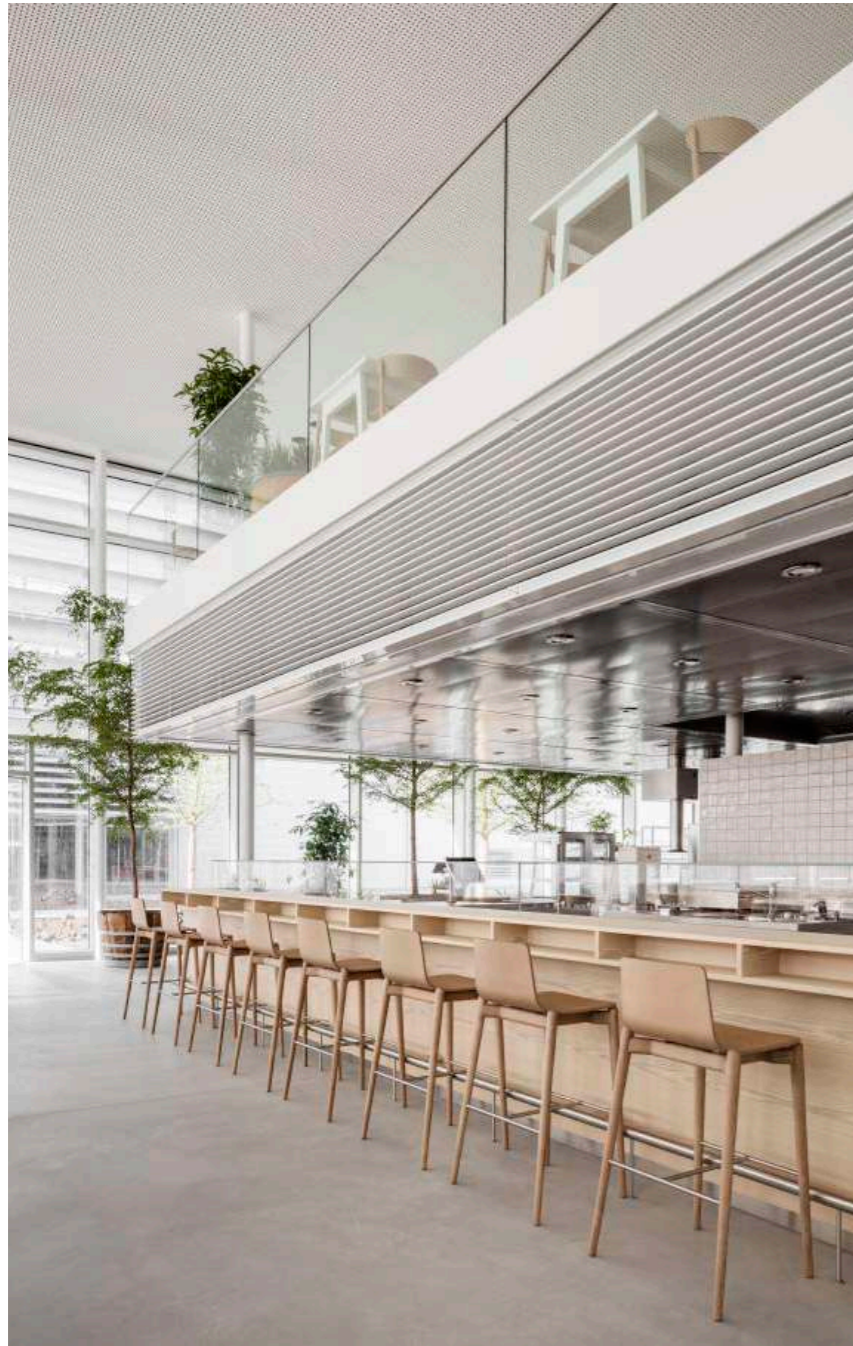

Peri Werk

Weissenhorn,
Germany

Project: Company
Canteen

Products: Malmö
barstool



Unit4 Offices

Stockholm, Sweden

Project: Offices

Products: Malmö barstool, Babila side chair
and armchair, Host modular seating, Inox table,
L001 lighting

390

Ash wood side chair



391

Ash wood side chair,
upholstered shell



392

Ash wood side chair,
leather shell



395

Ash wood armchair



396

Ash wood armchair,
upholstered shell



397

Ash wood armchair,
leather shell



295 Malmö Lounge

Ash wood lounge armchair



296 Malmö Lounge

Ash wood lounge armchair,
upholstered shell



297 Malmö Lounge

Ash wood lounge armchair,
leather shell



299 Malmö Relax

Ash wood lounge armchair



298 Malmö Relax

Ash wood lounge armchair,
upholstered shell



232

Ash wood barstool,
stainless steel footrest



242

Ash wood barstool, upholstered
shell, stainless steel footrest



252

Ash wood barstool, leather
shell, stainless steel footrest



236

Ash wood barstool,
stainless steel footrest



246

Ash wood barstool, upholstered
shell, stainless steel footrest



256

Ash wood barstool, leather shell,
stainless steel footrest



TML_190X90

Extensible table, solid ash wood legs, plywood veneered / solid laminate top

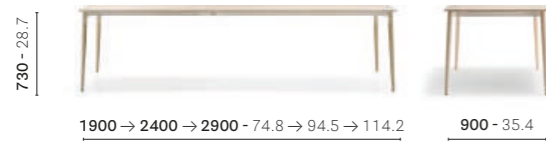

TMLF_90X90

Fixed table, solid ash wood legs, solid laminate top



TMLF_140X90

Fixed table, solid ash wood legs, solid laminate top



TMLF_180X90

Fixed table, solid ash wood legs, solid laminate top



MLTD100X36

Coffee table, solid ash wood legs, MDF / veneered / solid laminate* top



MLT120X74X36

Coffee table, solid ash wood legs, veneered / solid laminate* top



MLT_50X50X36

Coffee table, solid ash wood legs, veneered / MDF / solid laminate* top



MLT_50X50X48

Coffee table, solid ash wood legs, veneered / MDF / solid laminate* top



* Table height decreases of 10 mm for solid laminate top versions
L'altezza del tavolo si riduce di 10 mm per le versioni con ripiano in stratificato

MLTD_60X36

Coffee table, solid ash wood legs, veneered / MDF solid laminate* top



MLTD_60X48

Coffee table, solid ash wood legs, veneered / MDF solid laminate* top



MLT_60X60X36

Coffee table, solid ash wood legs, veneered / MDF solid laminate* top



MLT_60X60X48

Coffee table, solid ash wood legs, veneered / MDF solid laminate* top



MLTD_60X36

Coffee table, solid ash wood legs, marble top

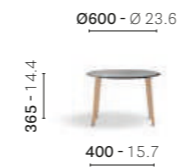

MLTD_60X48

Coffee table, solid ash wood legs, marble top



MLTD_70X36

Coffee table, solid ash wood legs, marble top



MLTD_70X48

Coffee table, solid ash wood legs, marble top



MLT_50X50X36

Coffee table, solid ash wood legs, marble top



MLT_50X50X48

Coffee table, solid ash wood legs, marble top



MLT_60X60X36

Coffee table, solid ash wood legs, marble top



MLT_60X60X48

Coffee table, solid ash wood legs, marble top



* Table height decreases of 10 mm for solid laminate top versions
L'altezza del tavolo si riduce di 10 mm per le versioni con ripiano in stratificato

SEATING FINISHES / FINITURE SEDUTE

coated ash / frassino verniciato



FR
Bleached ash
Frassino sbiancato

N1
Light walnut
Noce chiaro

lacquered ash with visible grains / frassino laccato a poro aperto

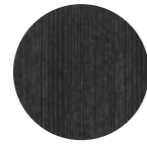

AN
Black
Nero

lacquered ash with visible grains / frassino laccato a poro aperto

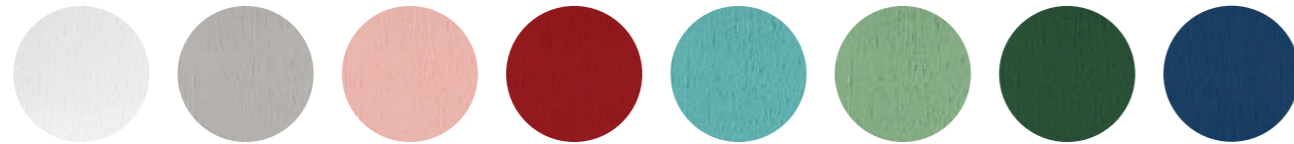

BI
White
Bianco

GC
Light grey
Grigio chiaro

RA
Pink
Rosa

RB
Ruby red
Rosso rubino

AZ1
Light blue
Azzurro

VE1
Light green
Verde chiaro

VE2
Dark green
Verde scuro

BL2
Dark blue
Blu scuro

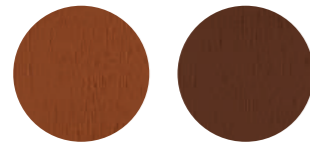

MC
Cognac

MO
Mahogany
Mogano

fabrics / tessuti

→ see booklet for finishes
vedi catalogo finiture

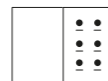

stainless steel / acciaio inox



AC
Brushed
Satinato

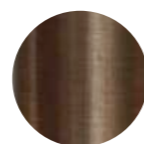

BS
Antique bronze
Bronzo anticato

TABLE FINISHES / FINITURE TAVOLO

solid laminate top / ripiano in stratificato



CFP_BI **COP_NERO** Fenix® Nero*

*Anti-fingerprint
Anti-impronta

lacquered MDF top / ripiano MDF laccato

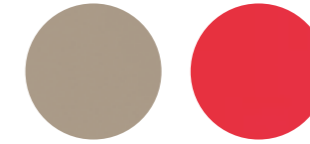

RAL1019 **RAL3018**

veneered ash wood top / ripiano impiallacciato frassino



FR
Bleached ash
Frassino sbiancato

AN
Black
Nero

marble top / ripiano in marmo

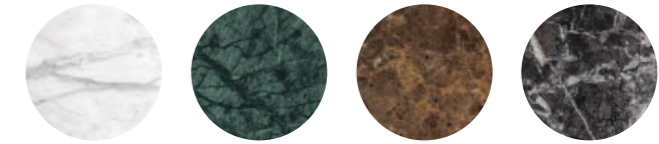

MBC
Bianco
Carrara

MVG
Verde
Guatemala

MED
Emperador
Dark

MGC
Grigio
Carnico

coated ash legs

gambe in frassino verniciato



FR
Bleached ash
Frassino sbiancato

lacquered ash legs with visible grains

gambe in frassino laccato a poro aperto



AN
Black
Nero

AWARDS / PREMI



CERTIFICATES / CERTIFICAZIONI

Safety, strength and durability tests / Prove di sicurezza, resistenza e durata
EN 1728:2012+AC2013 — EN 16139:2013 level 2 — EN 1728:2000



For 390 - 395 - 232
236 - 295 - 299

Folk

Now traditional chair

DESIGN
CMP Design, 2019

EN — Folk collection accentuates the quest for simplicity. Its friendly character, the warmth of ash wood, the soft and compact dimensions, human lines seamlessly convey the concept of a chair that speaks a universal language. The power of proportions is clearly evident in the time-tested forms, re-elaborated with the new possibilities offered by technology. The use of the cane seat guarantees visual lightness and maximum durability.

IT — La collezione Folk è il risultato di una ricerca della semplicità. Il carattere amichevole, il tepore del frassino, le dimensioni compatte, le linee morbide e umane sembrano trasmettere l'idea di sedia in un linguaggio universale. La forza della proporzione si esprime in modo chiaro nelle forme consolidate dalla tradizione rielaborate con nuove possibilità tecnologiche. L'utilizzo della paglia di Vienna garantisce leggerezza ottica e massima resistenza.



Chair

Sedia





2930



2940



TBA300X100

Barstool Sgabello

FSC® C114358
certified ash wood,
plant-derived
water-based paints
Frassino certificato FSC®
C114358 verniciato
all'acqua con vernici di
origine vegetale



Available in two
different heights
Disponibile in due
diverse altezze
650, 750 mm
25.6, 29.5 in



#pedralitales

Alcácer do Sal, Portugal

Project: 2020 ADV campaign

Products: Folk chair, Giravolta lighting





THE MART Spec Suite, 5th floor

Chicago, USA

Project: Office

Architect: Eastlake Studio with BOS

Products: Folk barstool



Bitpanda headquarters

Vienna, Austria

Project: Company Canteen and office

Architect: Alessandra Cetto

Products: Folk chair, Inox table

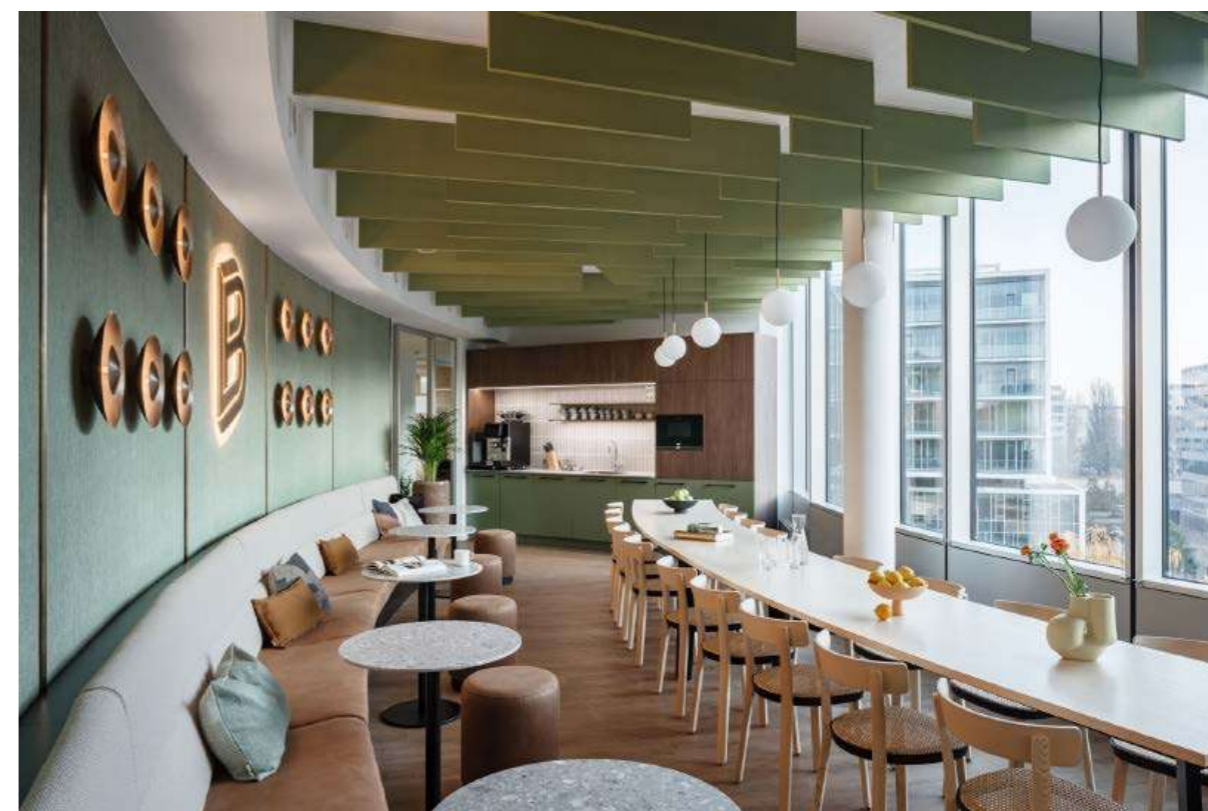

2930
Ash wood chair, die-cast aluminium ring



2920
Ash wood chair, natural cane seat, die-cast aluminium ring



2940
Ash wood chair, upholstered seat, die-cast aluminium ring



2936
Ash wood barstool, die-cast aluminium ring



2926
Ash wood barstool, natural cane seat, die-cast aluminium ring



2946
Ash wood barstool, upholstered seat, die-cast aluminium ring



2937
Ash wood barstool, die-cast aluminium ring



2927
Ash wood barstool, natural cane seat, die-cast aluminium ring



2947
Ash wood barstool, upholstered seat, die-cast aluminium ring



coated ash / frassino verniciato



fabrics / tessuti

→ see booklet for finishes
vedi catalogo finiture

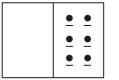

lacquered ash with visible grains / frassino laccato a poro aperto

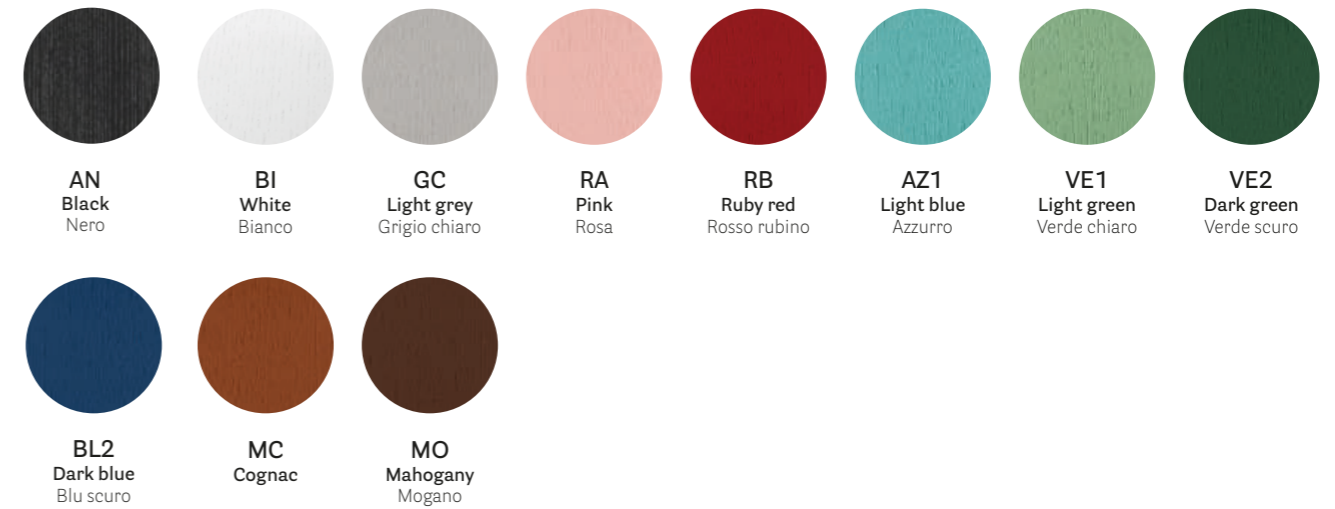

aluminium / alluminio



CERTIFICATES / CERTIFICAZIONI

Safety, strength and durability tests / Prove di sicurezza, resistenza e durata
EN 1728:2012+AC2013 — EN 16139:2013 level 2



Osaka

Ideogram chair

DESIGN
CMP Design, 2015

EN — Osaka is a collection of seatings with a strong graphic impact whose construction elements remind the linear features of an ideogram. Besides the ash wood version, those with metal frame emphasize their functionality conferring a high degree of lightness.

IT — Osaka è una collezione di sedute dal forte impatto grafico i cui elementi di costruzione appaiono nella loro purezza e semplicità formale, come i tratti lineari di un ideogramma. Accanto alle versioni in frassino quelle con telaio in metallo esaltano l'approccio funzionalista, donando un effetto visivo di estrema leggerezza.



WAITING

Lounge armchair poltrona lounge Osaka
Coffee table tavolino Lunar



Side chair sedia **Osaka**
Armchair poltrona **Osaka**
Modular seating seduta modulare **Modus**
Table tavolo **Inox**
Lighting lampada **L001**



DINING

DINING

Side chair sedia Osaka Metal
Armchair poltrona Osaka Metal
Barstool sgabello Osaka Metal
Table tavolo Lunar



Side chair

Sedia



Steel tube frame
Struttura in tubo d'acciaio
Ø 16 mm - Ø 0.63 in



Armchair

Poltrona





5715

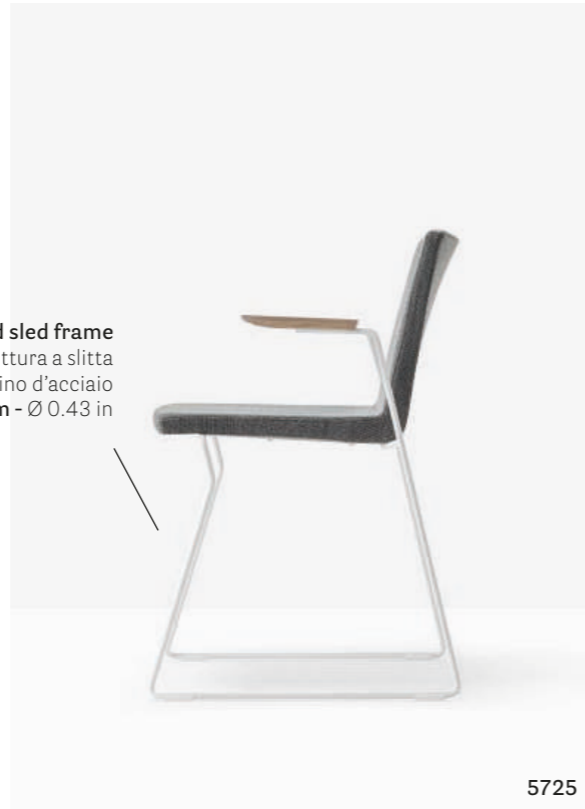

Steel rod sled frame
Struttura a slitta
in tondino d'acciaio
Ø 11 mm - Ø 0.43 in

5725



5729

Lounge chair

Seduta lounge

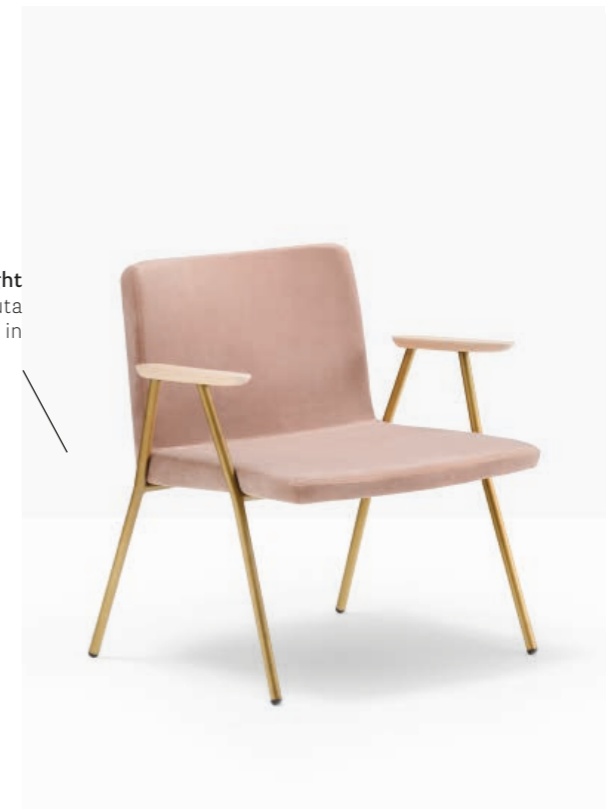

Seat height
Altezza seduta
410 mm - 16.1 in

Barstool

Sgabello

Seat height
Altezza seduta
650 mm - 25.6 in



5716



Aquarela Tower

Quito, Ecuador
Project: Office
Architect: Ateliers
Jean Nouvel
Products: Osaka Metal
armchair





Fundació Catalunya La Pedrera

Barcelona, Spain

Project: Office

Architect: Borrós Interiorisme

Product: Osaka Metal armchair



Ciam

Petrignano di Assisi, Italy

Project: Headquarters

Product: Osaka Metal side chair

Vemado office

Belgium

Project: Office

Architect: Buro Belgium

Products: Osaka Metal armchair, Arki-Table



SIZES / DIMENSIONI

mm - in

2810

Ash wood side chair



2811

Side chair, upholstered shell, ash wood frame



2815

Ash wood armchair



2816

Armchair, upholstered shell, ash wood frame



5711

Side chair, plywood shell, steel tube frame



5712

Armchair, plywood shell, steel tube frame



5714

Side chair, plywood shell, steel rod sled frame



5715

Armchair, plywood shell, steel rod sled frame



5721

Side chair, upholstered shell, steel tube frame



5722

Armchair, upholstered shell, steel tube frame



5724

Side chair, upholstered shell, steel rod sled frame



5725

Armchair, upholstered shell, steel rod sled frame



5729

Lounge Armchair, upholstered shell, steel tube frame



5716

Barstool, plywood shell, steel rod sled frame



5717

Barstool, plywood shell, steel rod sled frame



AWARDS / PREMI



coated ash / frassino verniciato



lacquered ash with visible grains / frassino laccato a poro aperto



lacquered ash with visible grains / frassino laccato a poro aperto

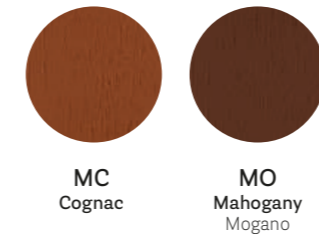
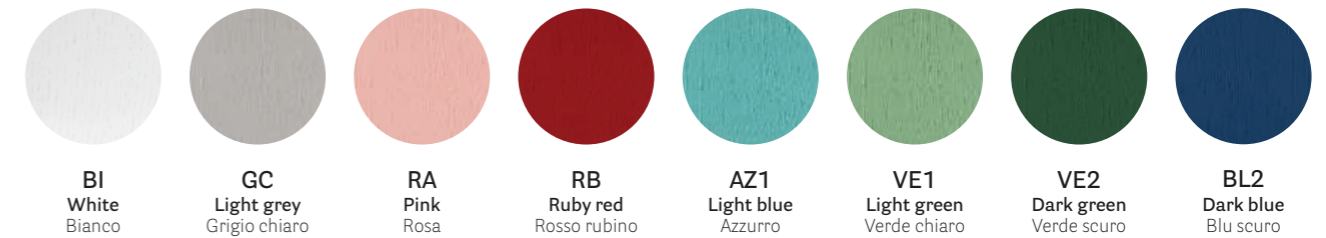

fabrics / tessuti

→ see booklet for finishes
vedi catalogo finiture

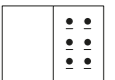

steel / acciaio

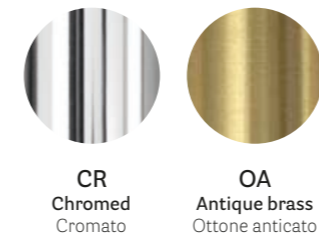

gold lacquered / laccato oro



powder coated / verniciato

→ see booklet for finishes
vedi catalogo finiture

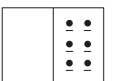

CERTIFICATES / CERTIFICAZIONI

Safety, strength and durability tests / Prove di sicurezza, resistenza e durata
EN 1728:2012+AC2013 — EN 16139:2013 level 2



For 2810 - 2815 - 5711
5714 - 5715 - 5716 - 5717

Zippo

A cosy atmosphere

DESIGN
Pedrali R&D, 2014

EN — The Zippo collection is composed by one or two seats sofa, conceived for lounge and informal meetings areas. A niche of privacy protected by high sides that ensure a good soundproof capacity.

IT — La collezione Zippo è composta da confortevoli divanetti a uno o a due posti, pensati per gli ambienti lounge e per le aree meeting. Una nicchia di privacy protetta da alti fianchi e schienale che garantiscono un'ottima capacità fonoassorbente.



WAITING

WAITING

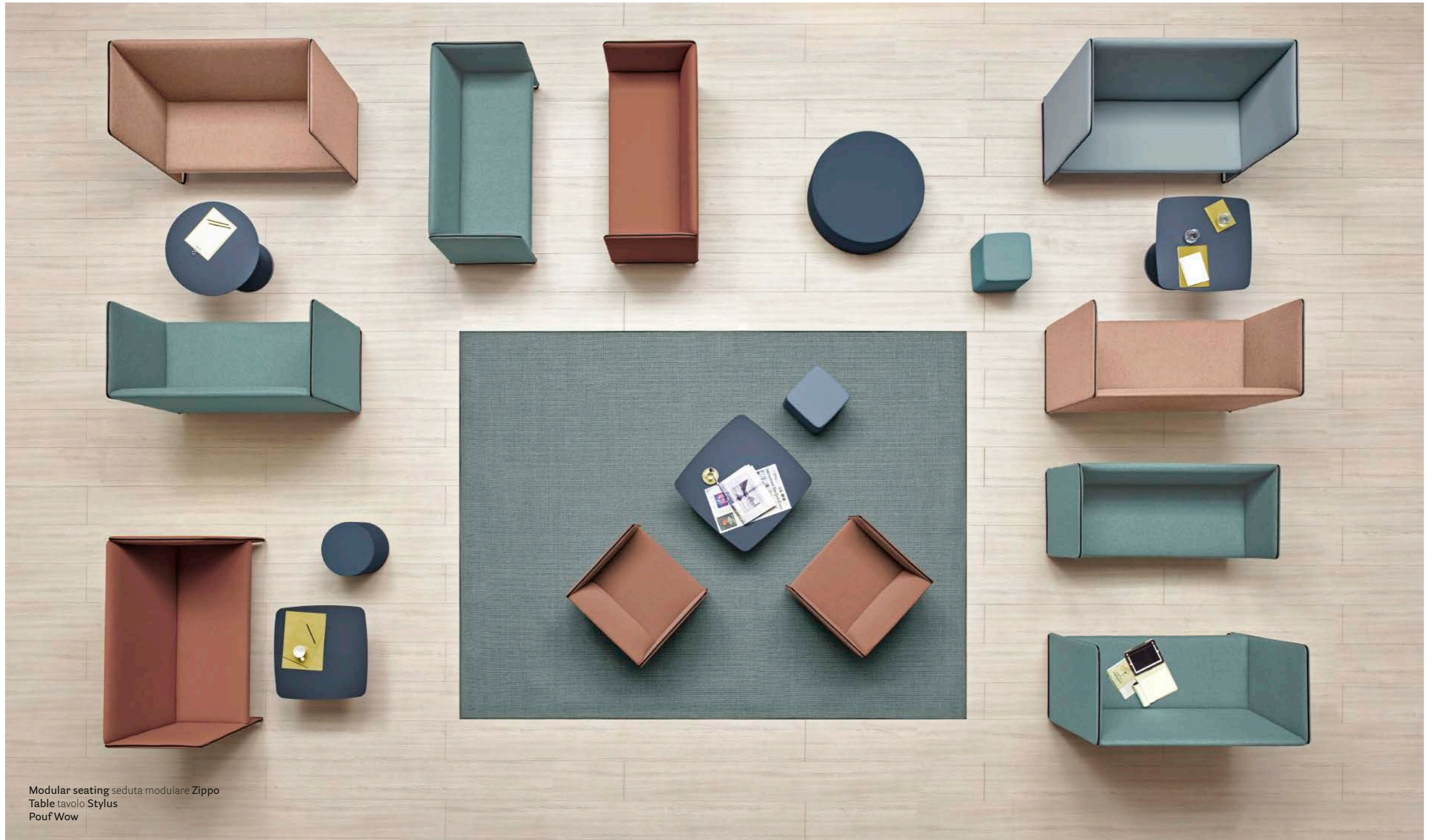

Modular seating seduta modulare Zippo
Table tavolo Stylus
Pouf Wow

Modular seating

Seduta modulare



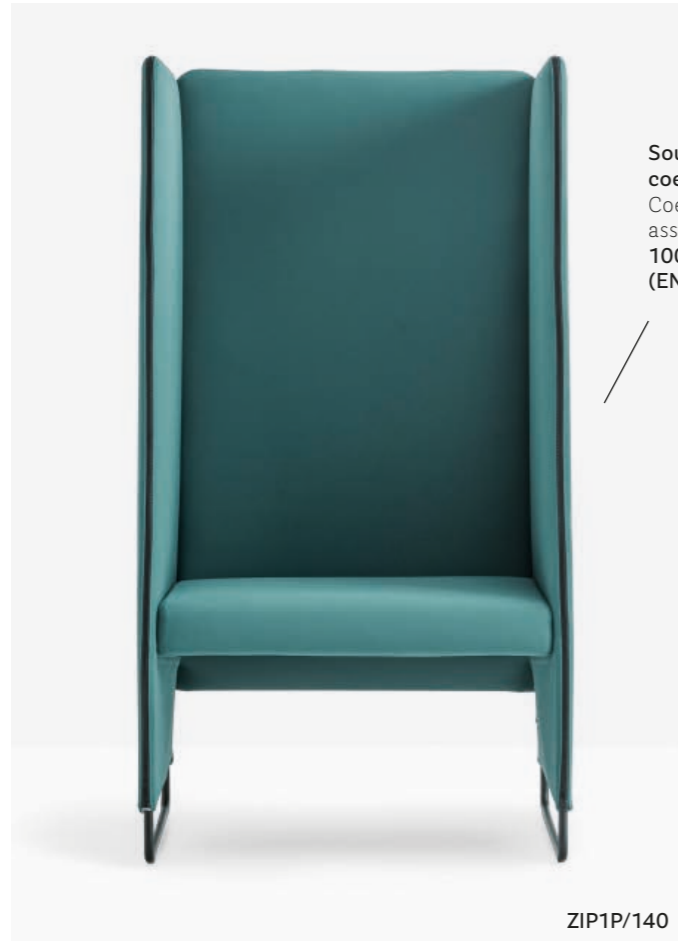

Sound absorption
coefficient
Coefficiente di
assorbimento acustico
100 Hz=1,46
(EN ISO 354:2003)

ZIP1P/140

Lounge version, depth
Versione lounge,
profondità
710 mm - 29.7 in



ZIPL1P



Aquarela Tower

Quito, Ecuador

Project: Office

Architect: Jean Nouvel Ateliers

Products: Zippo modular seating



Studio Nassini & Associati

Brescia, Italy

Project: Office

Products: Zippo modular seating,
Ypsilon coffee table, L001 lighting



MLC Senior School Burnwood

Sydney, Australia

Project: Educational
Products: Zippo modular
seating, Inox table

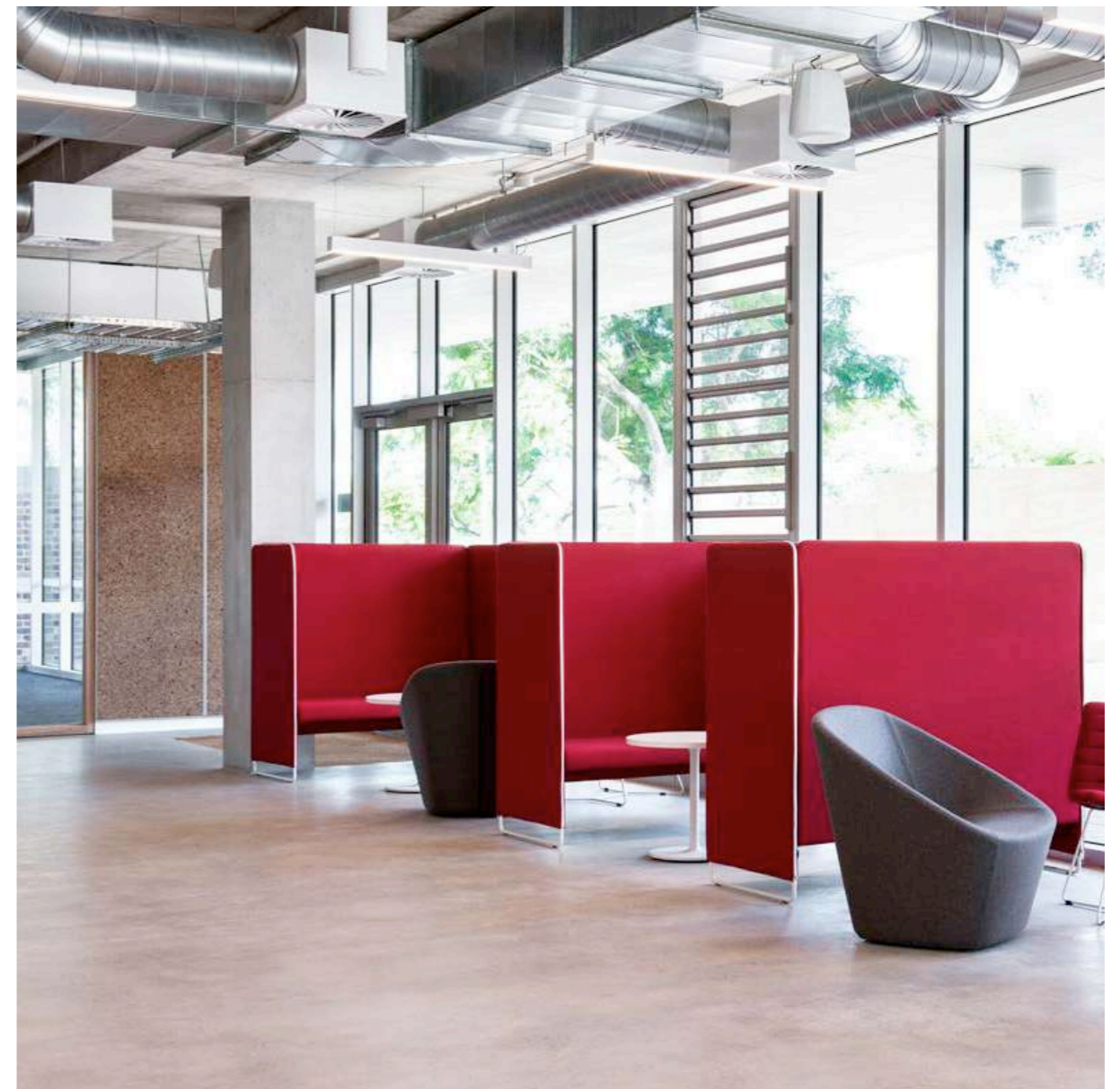



Unit4

Stockholm, Sweden

Project: Office

Products: Zippo modular seating,
Babila barstool, L001 lighting,
Colette lighting

SIZES / DIMENSIONI

mm - in

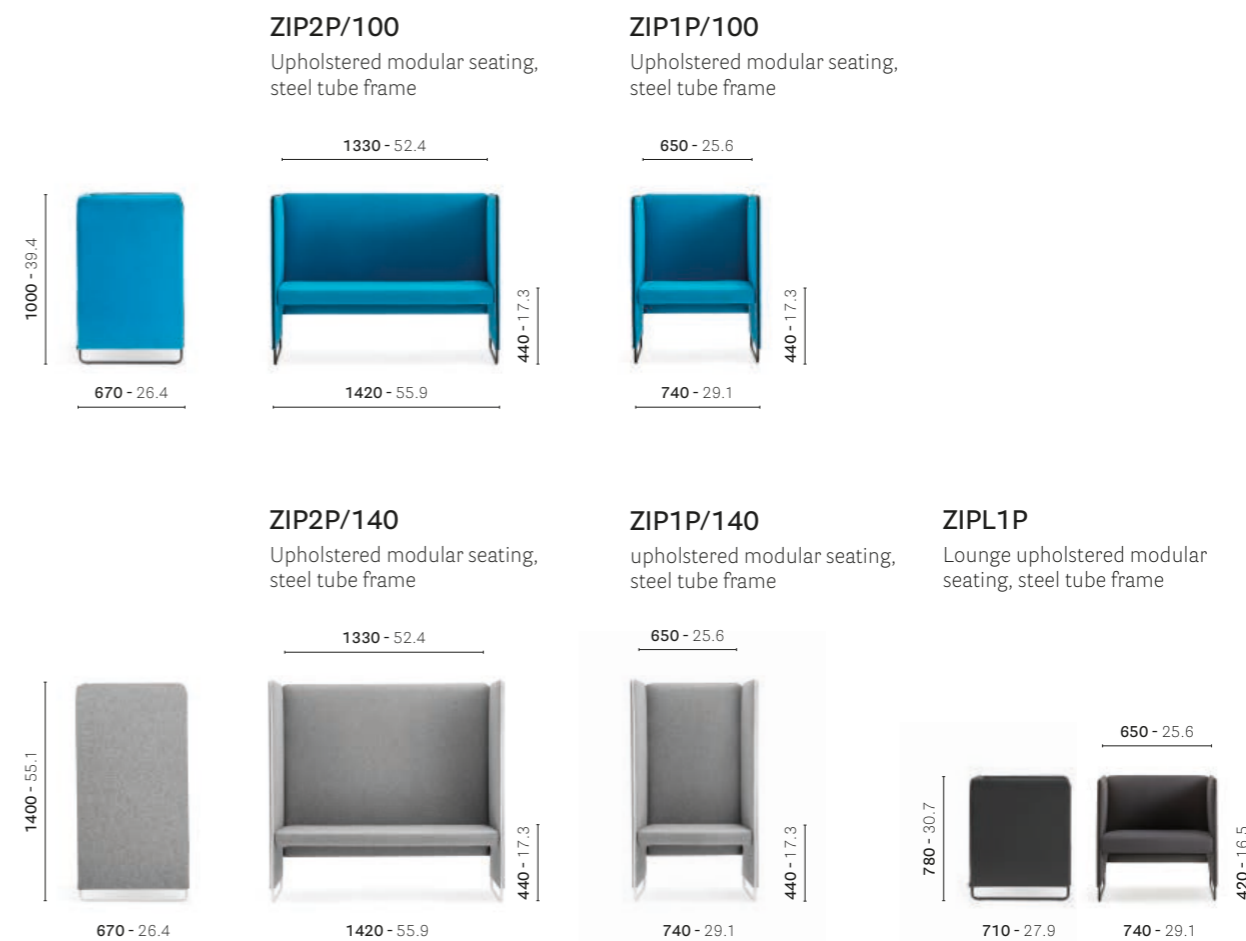

FINISHES / FINITURE

powder coated / verniciato

fabrics / tessuti



BI100

AL

NERO

→ see booklet for finishes
vedi catalogo finiture



CERTIFICATIONS / CERTIFICAZIONI

EN ISO 354:2003 "Acoustics - Measurement of sound absorption in a reverberation room"
EN ISO 354:2003 "Acustica - Misura dell'assorbimento acustico in camera riverberante"

Plural

Take your time

DESIGN
Jorge Pensi Design Studio, 2014

EN — The multiple seaters Plural are conceived for work activity, for waiting and leisure. A combination of materials, such as polypropylene for the seater and the aluminium die-cast aluminium frame. Plural represents an ideal solution for waiting areas in different environments. Plural Soft is even more comfortable and cosy while maintaining a minimalist design. The die-cast aluminium armrests, integrated with the injected polyurethane foam seats, define spaces while conveying a visual rhythm. Plural Soft end on both sides with functional tabletops. Ports for charging devices are integrated under the tabletop.

IT — Le sedute multiple Plural sono progettate per attività di lavoro, di attesa e di svago. Combinando materiali, quali il polipropilene della seduta e la pressofusione di alluminio del telaio, Plural rappresenta una soluzione ideale per connotare ambienti d'attesa di diversa natura. La versione soft è ancora più confortevole e accogliente mantenendo un design minimalista e leggero. I braccioli in pressofusione di alluminio si modulano con le sedute in schiumato poliuretano, delimitandone gli spazi e definendo un ritmo ordinato terminando alle due estremità con funzionali piani d'appoggio. Nel ripiano laterale sono integrate prese per la ricarica dei device.



WAITING

WAITING



WAITING

WAITING

Modular seating seduta modulare Plural Soft



WAITING

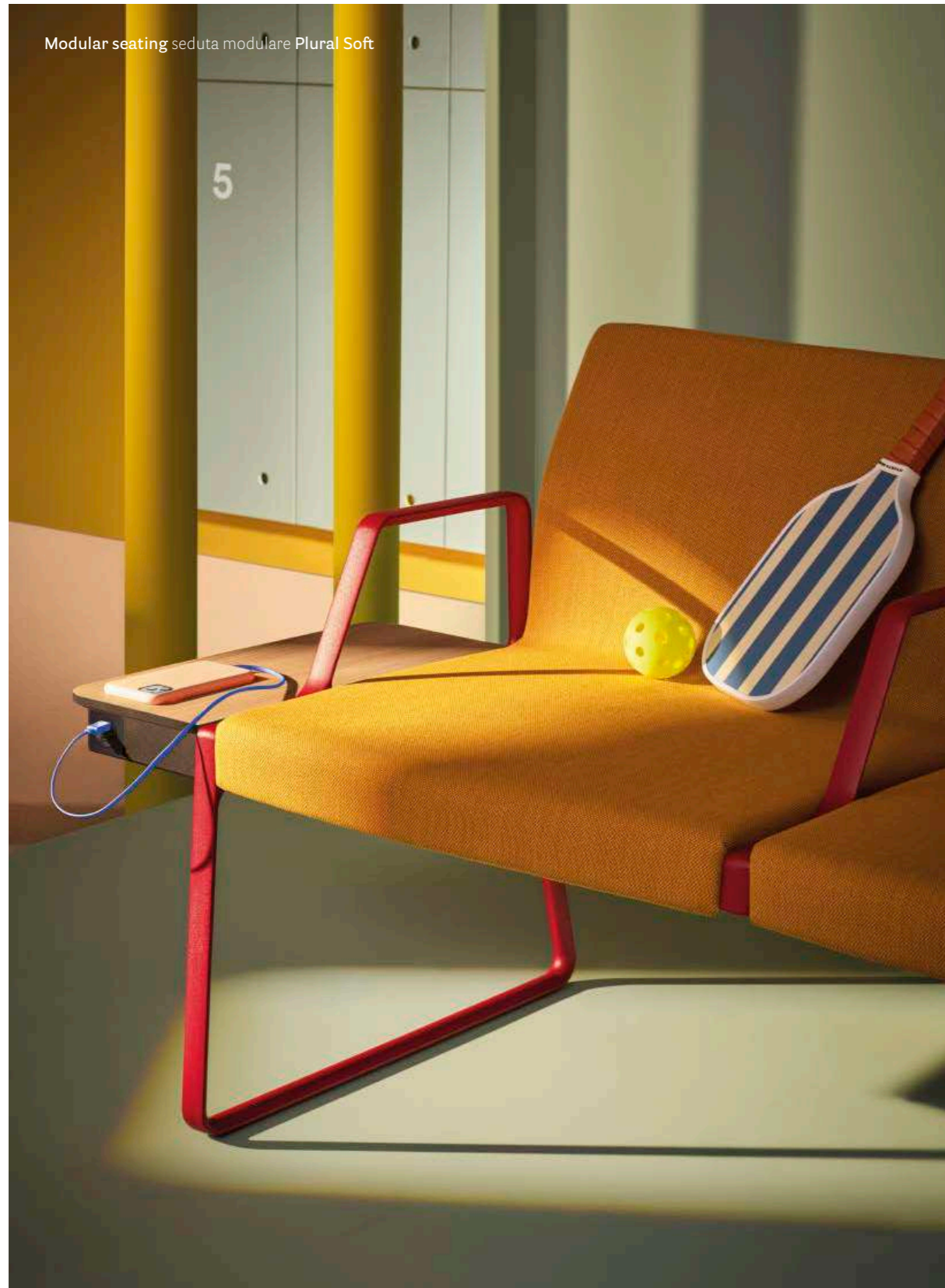

Modular seating seduta modulare Plural Soft

Modular seating Seduta modulare



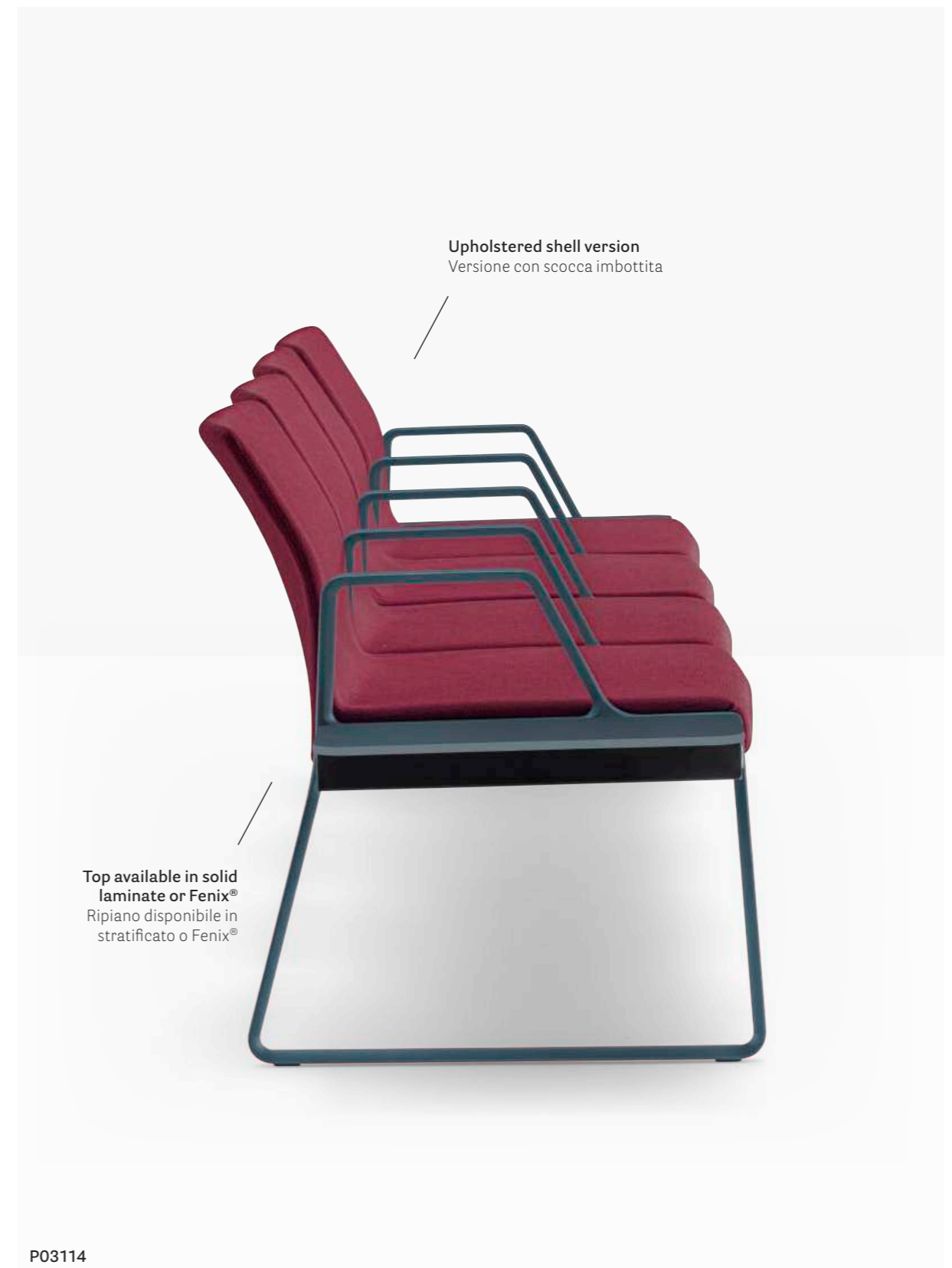

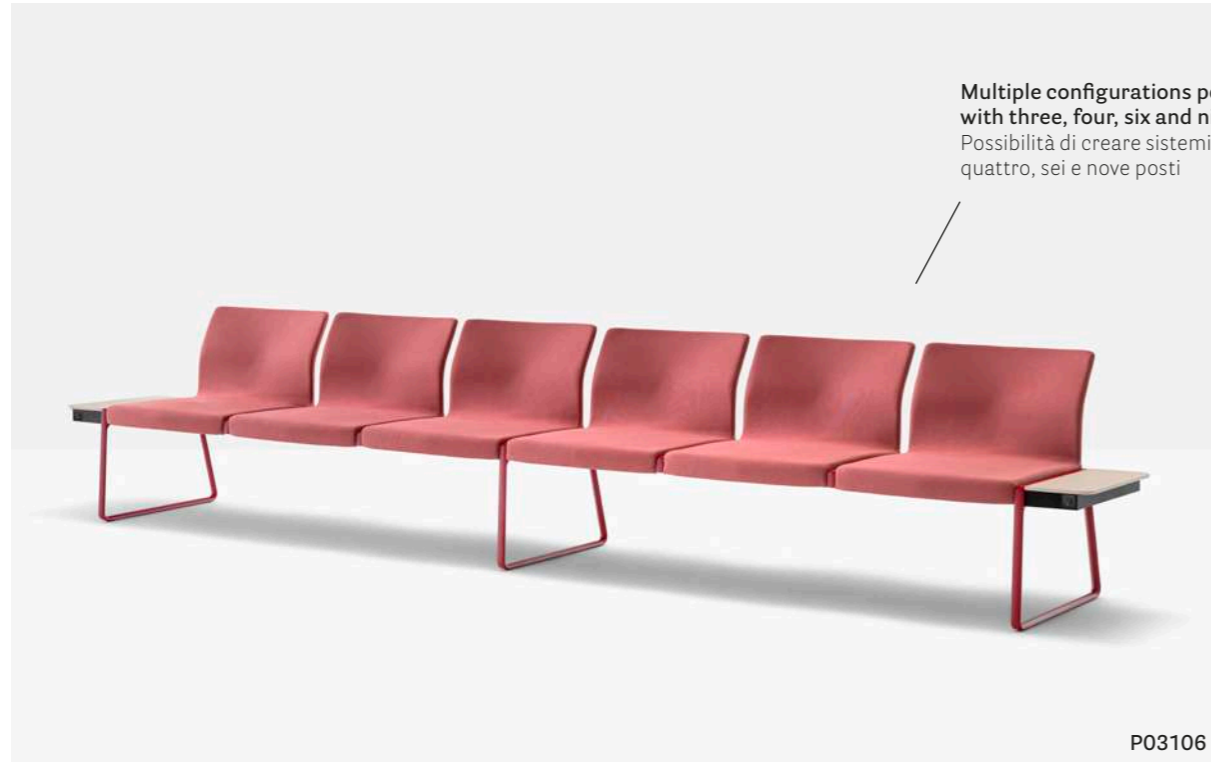

HPL side tabletop with ports for
charging devices
Ripiano laterale in HPL nel quale sono
integrate prese per la ricarica dei
device



Area Relax & Recharge

Host 2017
Milan, Italy

Project: Temporary installation
Product: Plural modular seating,
Time Out lighting, Volt barstool,
Ikon table, Social modular seating





Light Frames

Salone Internazionale
del Mobile 2015
Milan, Italy

Project: Exhibition stand
Architect: Migliore+Servetto Architects
Product: Plural modular seating

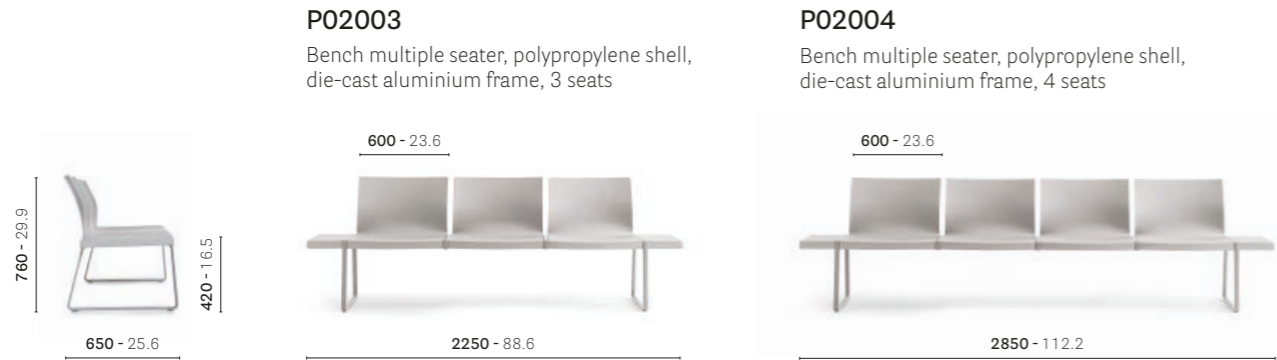

P02003

Bench multiple seater, polypropylene shell, die-cast aluminium frame, 3 seats

P02004

Bench multiple seater, polypropylene shell, die-cast aluminium frame, 4 seats

P02006

Bench multiple seater, polypropylene shell, die-cast aluminium frame, 6 seats



P02009

Bench multiple seater, polypropylene shell, die-cast aluminium frame, 9 seats



P02013, P02014, P02016, P02019

Bench multiple seater, polypropylene shell, die-cast aluminium frame with armrests, available in 3, 4, 6 and 9 seats



P02023, P02024, P02026, P02029

Bench multiple seater, polypropylene shell, die-cast aluminium frame with outside armrests, available in 3, 4, 6 and 9 seats



Upholstered seat

Available for every model of bench

P020_USB

USB optional kit

Floor fixing kit: surcharge

Kit di fissaggio a terra: supplemento



FINISHES / FINITURE

polypropylene / polipropilene



aluminium / alluminio

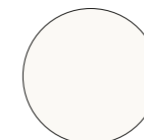

BI



BE



NE



CR
Chromed
Cromato

solid laminate top / ripiano in stratificato

fabrics and powder coated / tessuti e verniciato

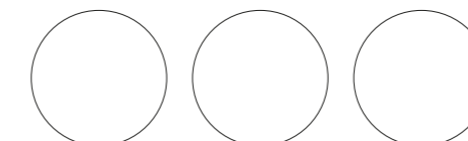

???

???

???

→ see booklet for finishes
vedi catalogo finiture

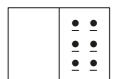

CERTIFICATES / CERTIFICAZIONI

Safety, strength and durability tests / Prove di sicurezza, resistenza e durata
EN 1728:2012+AC2013 — EN 16139:2013 level 2

Social

Create your community

DESIGN
Patrick Jouin, 2015

EN — Social is a modular system of linear, corner, curvy seatings and poufs, an endlessly replicable sofa ready to host social aggregations. Steel frame with die-cast aluminium legs.
IT — Social è un sistema modulare componibile di sedute lineari, angolari, curve e pouf che creano un divanetto replicabile all'infinito e pronto ad ospitare momenti di socialità.
Telaio in acciaio con gambe in pressofusione di alluminio.

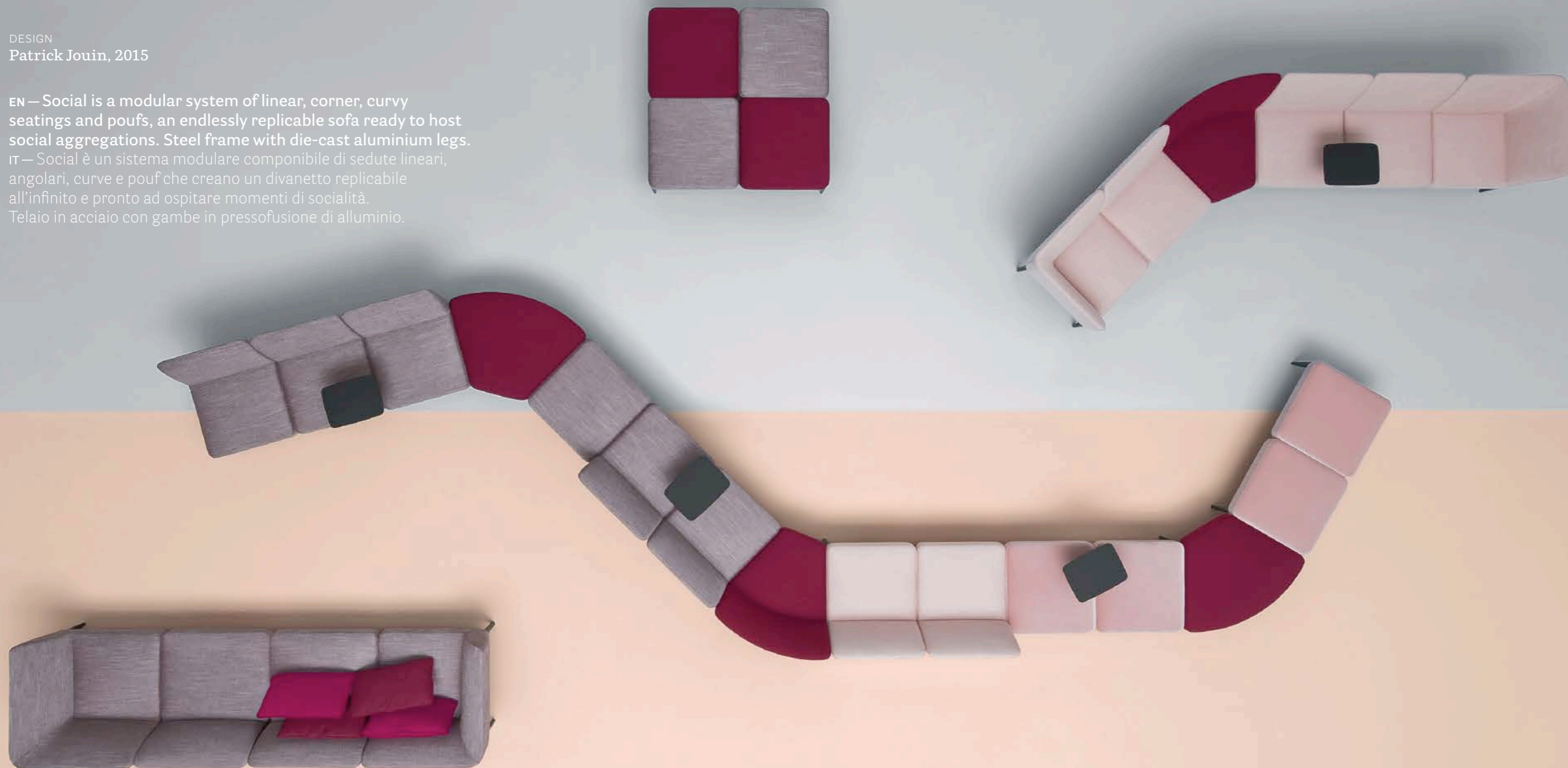

WAITING

WAITING

Sofa divano Social, Social Plus
Coffee table tavolino Code
Umbrella stand portaombrelli Brik
Coat hanger appendiabiti Flag Wall
Lighting lampada Colette



Sofa divano Social, Social Plus
Pouf Social

Social sofa, depth
Divano Social, profonđitã
660 mm - 26.0 in

Social Plus sofa, depth
Divano Social Plus, profonđitã
770 mm - 30.3 in



Modular seating

Seduta modulare



Die-cast aluminium leg,
polished or powder coated finish
Gamba in pressofusione di alluminio,
finitura lucida oppure verniciata



Polyurethane injected foam seats
system with elastic belts on the backrest
Sistema di sedute in schiumato poliuretano
con cinghie elastiche sullo schienale



DSO2_4ALLL



Turning tablet
Tavoletta girevole



Two, three or
four seating
Sistema a due, tre
o quattro sedute

DSO_3LLP



Seat height
Altezza seduta
410 mm - 16.1 in

DSO_2X2P



Cushions
Cuscini

DSO2_3AAL + DSO2.3



Parkhotel Brenscino

Brissago, Switzerland

Project: Hotel

Architect:
bernuzzisamoriarchitetti

Product: Log lounge armchair,
sofa and pouf, Social modular
seating, Wow pouf





Area Relax & Recharge

Host 2017
Milan, Italy

Project: Temporary installation
Products: Social modular seating,
Plural modular seating, Volt barstool,
Ikon poseur table, Happy Apple lighting

SOCIAL



Industrial Symphony

Mornico al Serio, Italy

Project: Showroom

Architect: CalviBrambilla

Products: Social Plus modular seating, Ila lounge armchair, Blume coffee table, Modus modular seating, L001 lighting, Héra armchair, Inox table

	<p>DSO_2L 2 linear seats sofa</p>  <p>660 - 26.0</p>	<p>DSO_3L 3 linear seats sofa</p>  <p>1190 - 46.8</p>	<p>DSO_4L 4 linear seats sofa</p>  <p>1780 - 70.1</p>	<p>DSO_4L 4 linear seats sofa</p>  <p>2370 - 93.3</p>
	<p>DSO_2LP 1 linear seat + 1 pouf sofa</p>  <p>1190 - 46.8</p>	<p>DSO_3LLP 2 linear seats + 1 pouf sofa</p>  <p>1780 - 70.1</p>		
	<p>DSO_2AL 1 corner + 1 linear seat sofa</p>  <p>660 - 26.0</p>	<p>DSO_3ALL 1 corner + 2 linear seats sofa</p>  <p>1250 - 49.2</p>	<p>DSO_3ALL 1 corner + 2 linear seats sofa</p>  <p>1840 - 72.4</p>	<p>DSO_4ALL 1 corner + 3 linear seats sofa</p>  <p>2430 - 95.7</p>
	<p>DSO_2A 2 corners sofa</p>  <p>1310 - 51.6</p>	<p>DSO_3AAL 2 corners + 1 linear seat sofa</p>  <p>1900 - 74.8</p>	<p>DSO_4AAL 2 corners + 2 linear seats sofa</p>  <p>2490 - 98.0</p>	

SIZES / DIMENSIONI

mm - in

DSO_2P
2 poufs



DSO_3P
3 poufs



DSO_2X2P
4 poufs



DSO45C
Modular corner 45°
with backrest

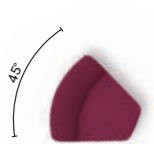

DSO60P
Modular corner 60°
without backrest

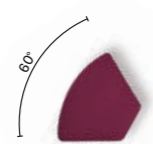

DSO90C
Modular corner 90°
with backrest

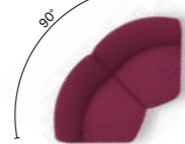

DSO/TT
Turning tablet



SOCIAL PLUS

DSO2_2L
2 linear seats sofa



DSO2_3L
3 linear seats sofa



DSO2_4L
4 linear seats sofa



DSO2_2AL
1 corner + 1 linear seat sofa



DSO2_3ALL
1 corner + 2 linear seats sofa



DSO2_4ALL
1 corner + 3 linear seats sofa



SIZES / DIMENSIONI

DSO2_2A
2 corners sofa



DSO2_3AAL
2 corners + 1 linear seat sofa



DSO2_4AALL
2 corners + 2 linear seats sofa



DSO2.3
Cushion only



DSO_LINK
Connecting plate kit

FINISHES / FINITURE

fabrics / tessuti

→ see booklet for finishes
vedi catalogo finiture

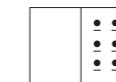

powder coated / verniciato

→ see booklet for finishes
vedi catalogo finiture

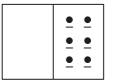

aluminium / alluminio



LU
Polished
Lucidato

solid laminate / stratificato

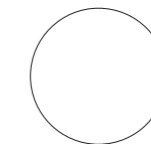

CFP_BI



FNP_NE
Anti-fingerprint finish
Finitura anti-impronta

AWARDS / PREMI



CERTIFICATIONS / CERTIFICAZIONI

Safety, strength and durability tests /
Prove di sicurezza, resistenza e durata
EN 1728:2012+AC2013 — EN 16139:2013 level 2

Omologation "Class 1IM"
Omologazione "Classe 1IM"

Log

Soft sculpture

DESIGN
Busetti Garuti Redaelli, 2014

EN — Log is a collection of completely upholstered seatings which marries a sculptural aspect with surprising lightness. The right combination of formal balance, stability and comfort.

IT — Log è una collezione di sedute completamente imbottite che coniuga un aspetto scultoreo ad una sorprendente leggerezza. La giusta combinazione tra equilibrio formale, stabilità e comfort.



WORKSPACE

WORKSPACE



Armchair poltrona Log
Lounge armchair poltrona lounge Log
Table tavolo Arki-Table
Coffee table tavolino Code
Lighting lampada Happy Apple

WAITING

WAITING



Armchair poltrona Log
Lounge armchair poltrona lounge Log
Sofa divano Log
Pouf Log
Coffee table tavolino Parenthesis
Coffee table tavolino Laja
Coffee table tavolino Malmö

Armchair

Poltrona



Lounge armchair

Poltrona lounge



Sofa
Divano



Two seats
upholstered sofa
Divano imbottito
a due posti

368 + 367

Bohem La Stazione

Paratico, Italy

Project: Florist, Café & Restaurant
Products: Log armchair, Inox table,
Tweet armchair, Nolita armchair
and table





U219 Business Centre

Vilnius, Lithuania

Project: Office

Architect: Cloud Architects

Products: Log armchair
and lounge armchair, Inox table



Hotel Marquis Issabel's

Granada, Spain

Project: Hotel

Architects: ILMIODESIGN -
Andrea Spada, Michele Corbani

Product: Log armchair

SIZES / DIMENSIONI

mm - in

365

Upholstered armchair



366

Upholstered lounge armchair



367

Upholstered pouf



368

Upholstered sofa



FINISHES / FINITURE

fabrics / tessuti

→ see booklet for finishes
vedi catalogo finiture

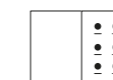

CERTIFICATES / CERTIFICAZIONI

Safety, strength and durability tests / Prove di sicurezza, resistenza e durata
EN 1728:2012+AC2013 — EN 16139:2013 level 2

Volt

Injection of dynamism

DESIGN
Claudio Dondoli - Marco Pocci, 2013

EN — The thin sections, along with ergonomic shape and lovely proportions make Volt a collection of polypropylene chairs that stands out for attention to details. Volt is elegant, cozy, equally lightweight and handy, featured by thin edges and chamfered profiles. All the models in the collection are also available with padded seat version.

IT — Il tratto sottile, la forma ergonomica e le gradevoli proporzioni rendono Volt una collezione di sedute in polipropilene che si distingue per la cura dei dettagli. Leggera e facile da maneggiare, caratterizzata da spessori esili e profili smussati, Volt è elegante e accogliente. Tutti i modelli della collezione sono disponibili anche con sedile imbottito.



Side chair sedia Volt
 Armchair poltrona Volt
 Table tavolo Ypsilon



SIDE CHAIR / SEDIA



SIDE CHAIR AND ARMCHAIR / SEDIA E POLTRONA





Upholstered seat version
Versione con seduta imbottita

676



869



Stackable
Impilabile

675

Seat height
Altezza seduta
660 mm - 26.0 in



Armofer padiglione culturale-ricreativo

Pavia, Italy

Project: Educational

Architect: fabiogianoliinteriordesigner

Product: Volt armchair, Ypsilon table





Microsoft House

Milan, Italy

Project: Office

Architects: Herzog & de Meuron (building architecture),
DEGW - brand of Lombardini22 (Interior Design & Space Planning)

Products: Volt side chair, Malmö side chair, Modus modular seating, Arki-Base table, Happy Apple lighting

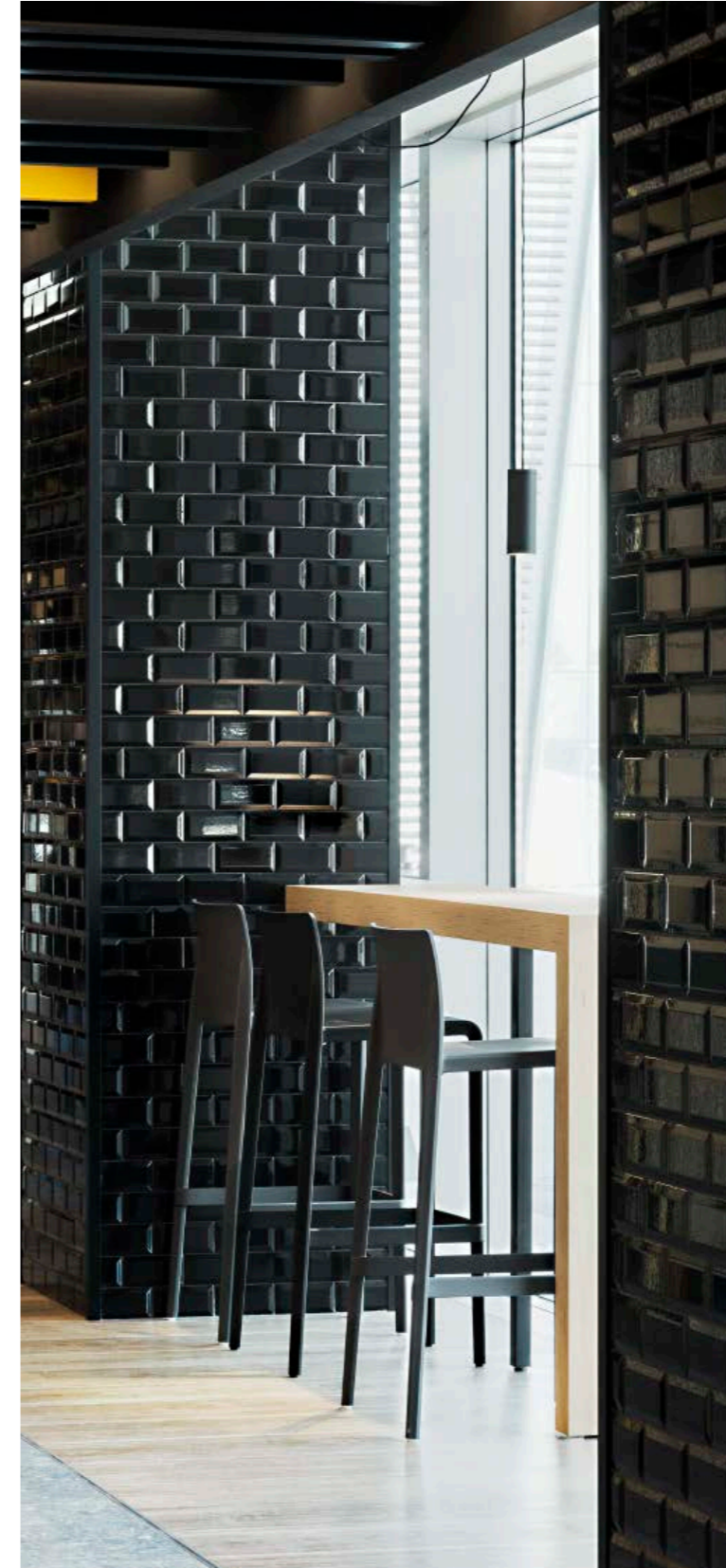

Kilometro Rosso

Bergamo, Italy

Project: Company Canteen

Architect: Luca Bombassei Studio

Products: Volt barstool

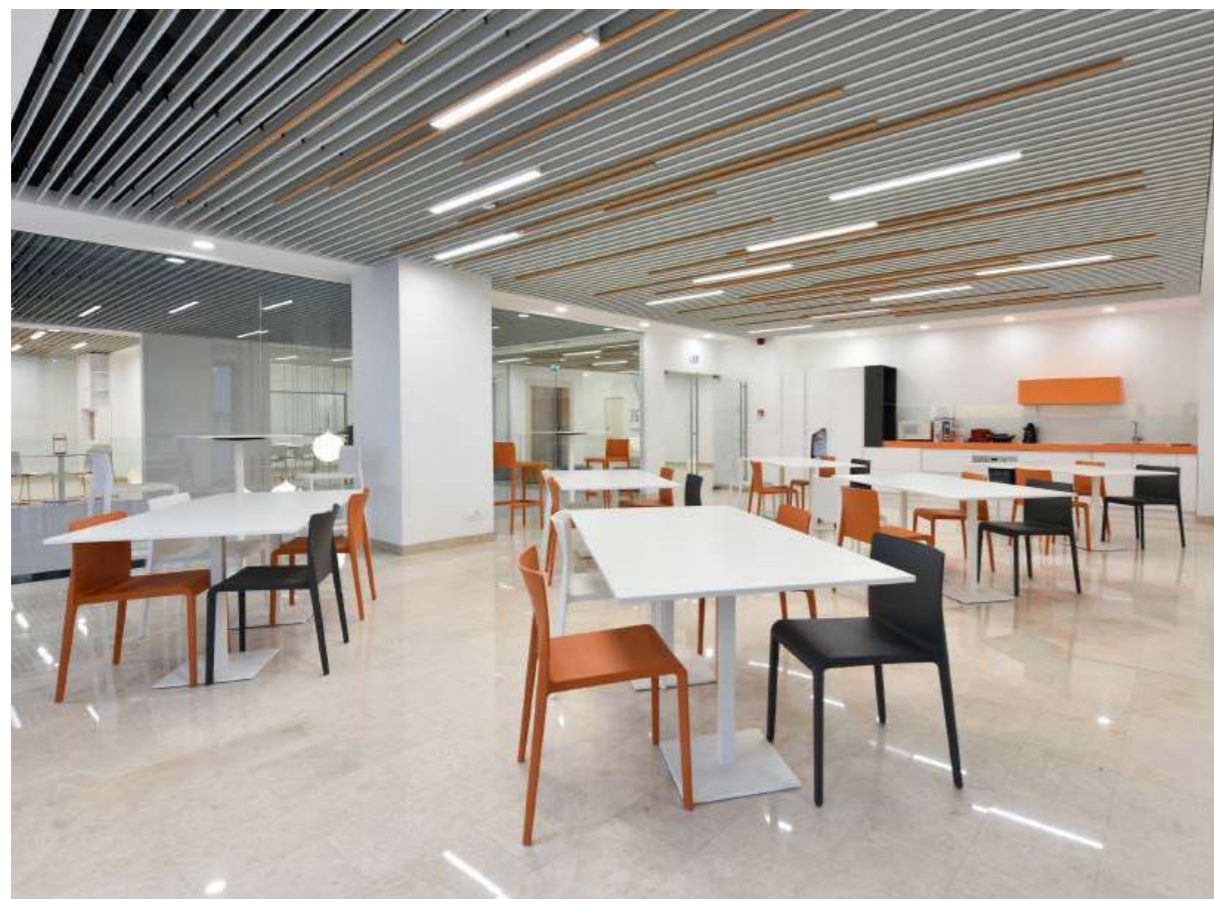

Mediclim office

Otopeni, Romania

Project: Office

Architect: Ioana Nicolescu / Polisemy

Products: Volt side chair and barstool,
Inox table

670
Polypropylene side chair



670/CL1
Polypropylene side chair,
fire-retardant grade



670RM
Recycled polypropylene
side chair



673
Polypropylene side chair, high back



671
Polypropylene side chair,
upholstered front shell



671/2
Polypropylene side chair,
upholstered seat



673/2
Polypropylene side chair,
high back, upholstered seat



673RM
Recycled polypropylene
side chair, high back



675
Polypropylene armchair



675/CL1
Polypropylene armchair,
fire-retardant grade



675RM
Recycled polypropylene
armchair



674
Polypropylene armchair, high back



SIZES / DIMENSIONI

mm - in

674RM
Recycled polypropylene
armchair, high back



676
Polypropylene armchair,
upholstered front shell



676/2
Polypropylene armchair,
upholstered seat



674/2
Polypropylene armchair,
high back, upholstered seat



677
Polypropylene barstool



677/2
Polypropylene barstool,
upholstered seat



677RM
Recycled polypropylene
barstool



678
Polypropylene barstool



678/2
Polypropylene barstool,
upholstered seat



678RM
Recycled polypropylene
barstool



FINISHES / FINITURE

polypropylene / polipropilene

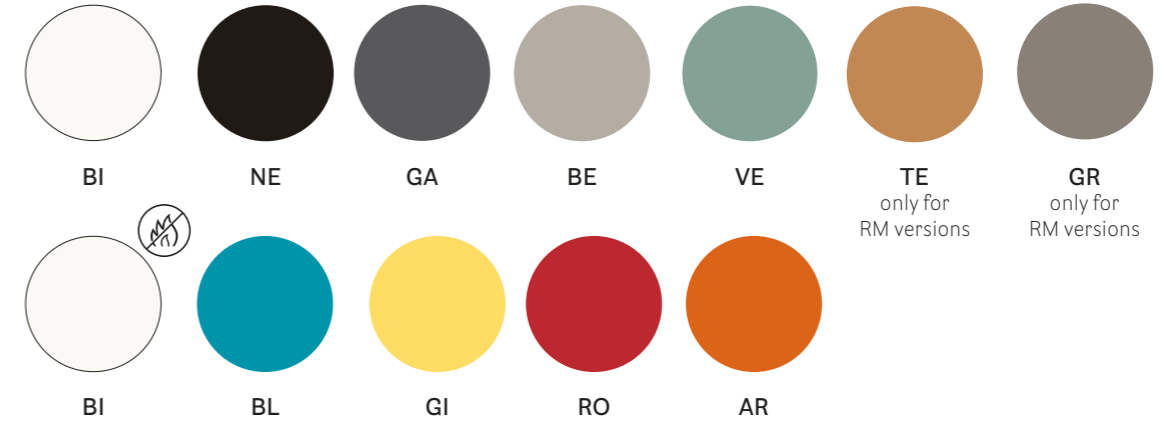

fabrics / tessuti

→ see booklet for finishes
vedi catalogo finiture

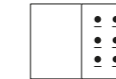

AWARDS / PREMI



reddot award 2014
winner

CERTIFICATES / CERTIFICAZIONI

Safety, strength and durability tests / Prove di sicurezza, resistenza e durata
EN 1728:2012+AC2013 — EN 16139:2013 level 2 — ANSI-BIFMA X5.1-2017



For
670 - 673 - 674
675 - 677 - 678

Dome

Multimaterial language

DESIGN
Odo Fioravanti, 2016

EN — Dome is a collection of seating that brings back to mind the glorious tradition of the bistro chairs with curved silhouettes and generous shapes. It recalls the domes of the monuments adorning a lot of cities all around the world.

IT — Dome è una collezione di sedute che evoca la gloriosa tradizione delle sedie da bistro con silhouette arcuate e le generose forme delle cupole dei monumenti che impreziosiscono molte città nel mondo.



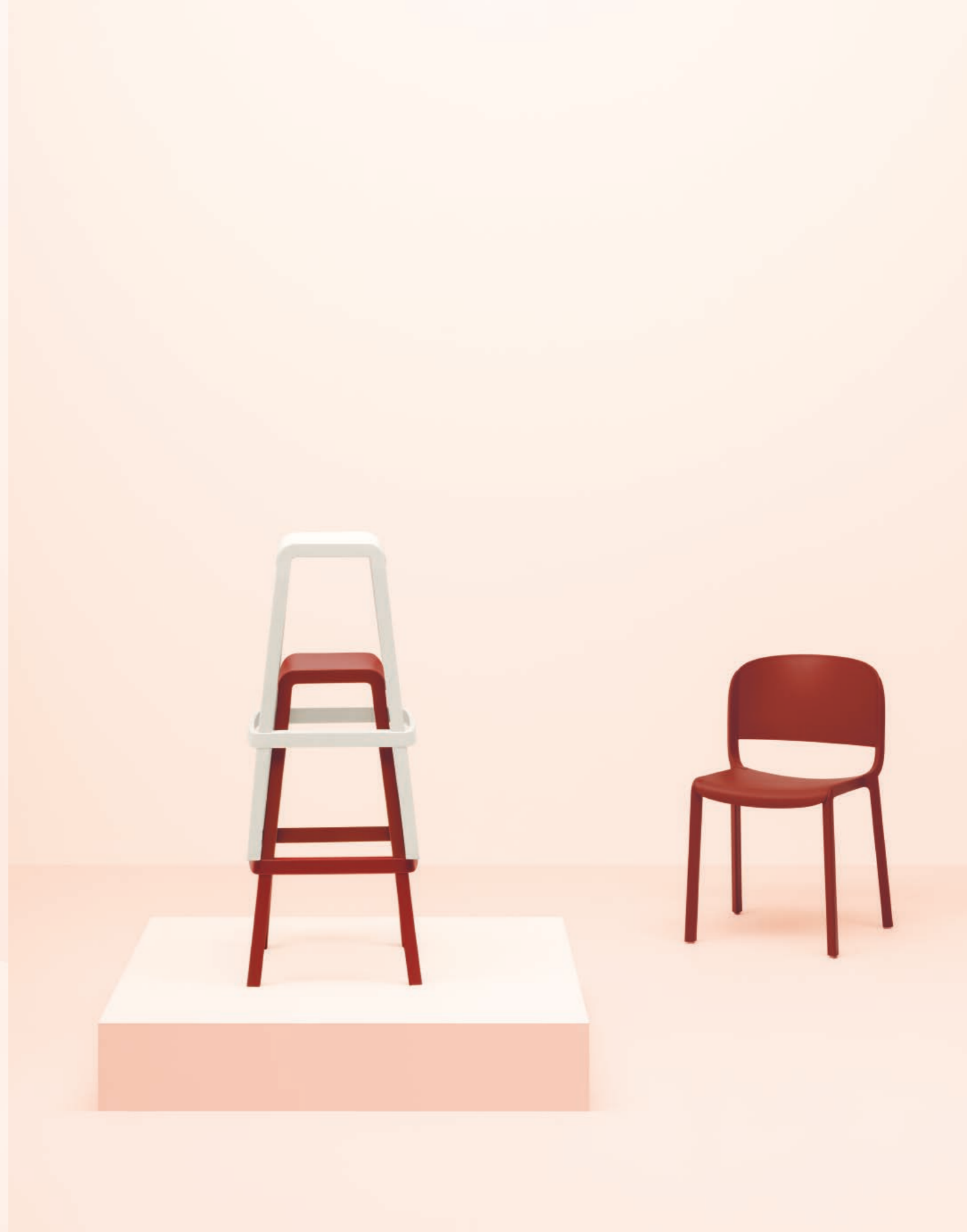

Side chair sedia Dome
Armchair poltrona Dome
Table tavolo Arki-Base
Lighting lampada TO.BE



Barstool sgabello Dome



**Gas air moulding
polypropylene,
fiberglass charged**
Stampaggio a iniezione
assistito da gas,
caricato fibre di vetro



265





Perforated seat
and back version
Versione con seduta
e schienale traforati

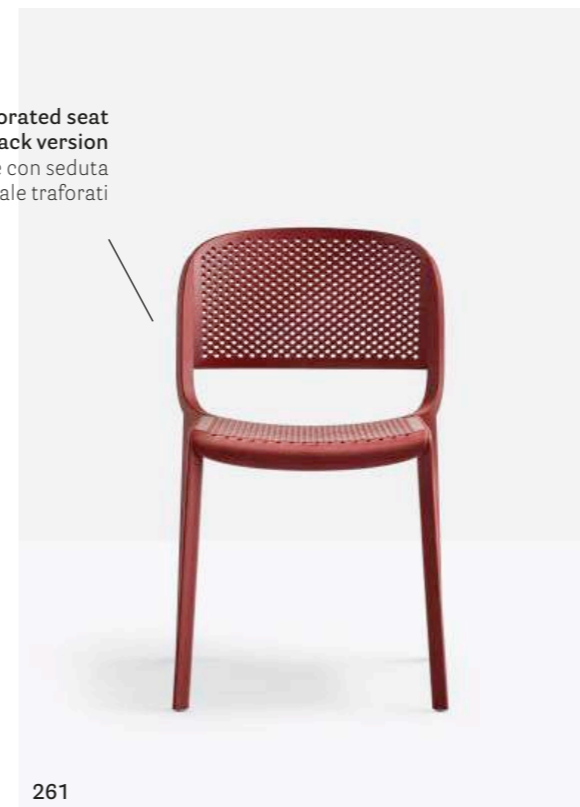

BARSTOOL / SGABELLO

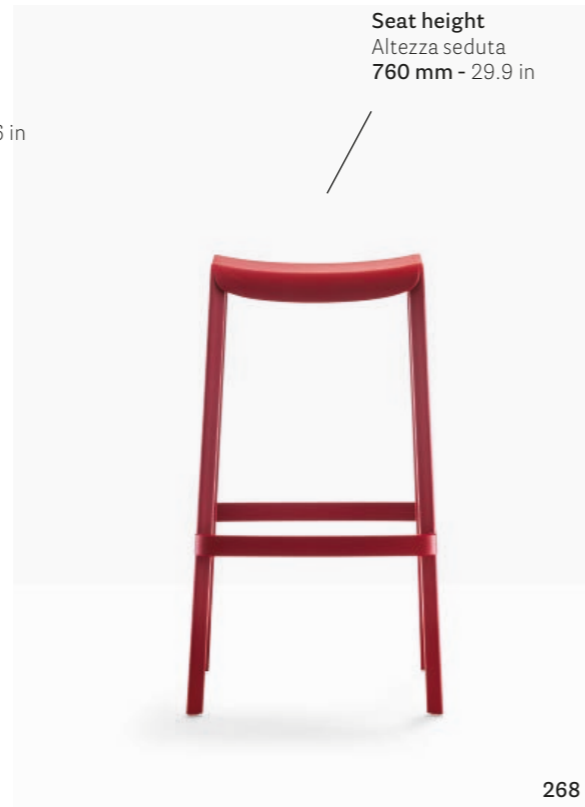

Adi Design Museum

Milan, Italy

Project: Theatre and museum
Products: Dome side chair





Pedrali company canteen

Bergamo, Italy

Project: Company Canteen

Architect: Park Associati

Products: Dome side chair, Arki-Table, Folk side chair, Hevea pot holder, TO.BE lighting, Volt side chair, Fabbrico table

Bibliotheek Permeke

Antwerp, Belgium

Project: Library

Architect: pieterbostoen.com

Product: Dome side chair, Stylus table and poseur table, Nolita barstool, Buddy pouf with backrest





Centrale Coffee Bar

Lviv, Ukraine

Project: Coffee bar

Architect: LTStudio

Products: Dome barstool

Siemens Israel Offices

Rosh Haayin, Israel

Project: Company Canteen

Architect: EN Design Studio

Products: Dome side chair
and armchair, Bold table,
Osaka Metal barstool



SIZES / DIMENSIONI

mm - in

260

Polypropylene side chair



261

Polypropylene side chair with perforated seat and back



260/CL1

Polypropylene side chair, fire-retardant grade



265

Polypropylene armchair



266

Polypropylene armchair with perforated seat and back



265/CL1

Polypropylene armchair, fire-retardant grade



267

Polypropylene barstool



268

Polypropylene barstool



262

Polypropylene barstool



263

Polypropylene barstool



FINISHES / FINITURE

polypropylene / polipropilene

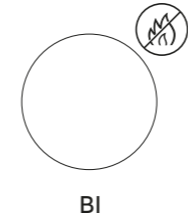
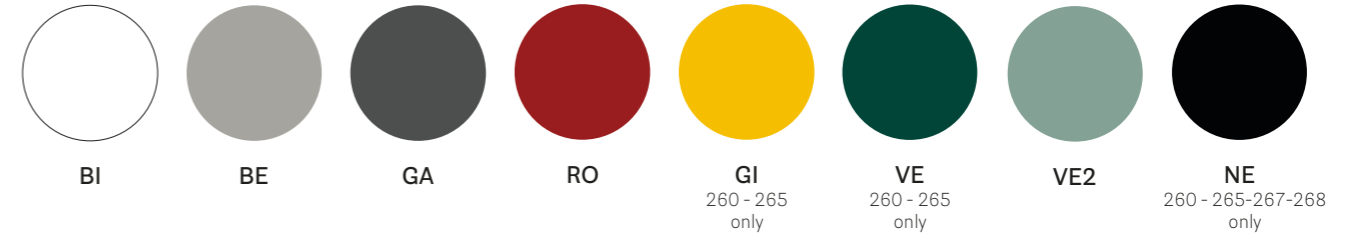

AWARDS / PREMI



CERTIFICATES / CERTIFICAZIONI

Safety, strength and durability tests / Prove di sicurezza, resistenza e durata
EN 1728:2012+AC2013 — EN 16139:2013 level 2



Nemea

Athletic agility

DESIGN
CMP Design, 2015

EN — Nemea collection design recalls a classic gracefulness molded by time and history. The chair, with its slender legs in solid ash wood inserted into die-cast aluminum frame, it truly appears jumping forward as an athletic step full of energy and grace.

IT — Nemea è una collezione di sedute la cui forma richiama una leggiadria classica plasmata dal tempo e dalla storia. La sedia, con le sinuose gambe in massello di frassino innestate al telaio in pressofusione di alluminio, appare infatti protesa in uno scatto atletico ricco di energia e grazia.



DINING

DINING

Side chair sedia Nemea
Armchair poltrona Nemea
Table tavolo Stylus



DINING

ARMCHAIR / POLTRONA



Side chair Sedia

Solid ash wood legs
Gambe in massello
di frassino



Die-cast
aluminium frame
Struttura in
pressofusione
di alluminio



2820

Ash veneered
plywood seat
Seduta in multistrato
di frassino



Upholstered seat
Seduta imbottita



2826

Armchair Poltrona

Lacquered
ash wood
Frassino laccato



2825



Moleskine Café

Milan, Italy

Project: Contemporary literary café

Products: Nemea side chair and armchair, Laja table, Malmö barstool, Lounge armchair and coffee table, Nolita side chair and barstool, Ypsilon table

CEDIT - Ceramiche d'Italia

Fiorano Modenese, Italy

Project: "Matrice" collection
by CEDIT - Ceramiche d'Italia

Architect: BHR+

Products: Nemea side chair
and armchair



Peri Werk

Weissenhorn, Germany

Project: Company canteen

Products: Nemea side chair, Gliss armchair, Bold table, Malmö Lounge armchair, coffee table and barstool, Nolita side chair, lounge armchair, barstool and table



2820

Ash wood side chair, die-cast aluminium frame



2821

Ash wood side chair, upholstered seat, die-cast aluminium frame



2825

Ash wood armchair, die-cast aluminium frame



2826

Ash wood armchair, upholstered seat, die-cast aluminium frame



coated ash / frassino verniciato



lacquered ash with visible grains / frassino laccato a poro aperto

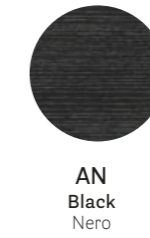

lacquered ash with visible grains / frassino laccato a poro aperto



fabrics / tessuti

→ see booklet for finishes
vedi catalogo finiture

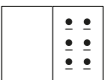

aluminium / alluminio

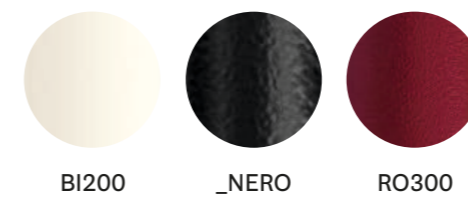

CERTIFICATES / CERTIFICAZIONI

Safety, strength and durability tests / Prove di sicurezza, resistenza e durata
EN 1728:2012+AC2013 — EN 16139:2013 level 2



For 2820 - 2825

Ray

Natural gesture

DESIGN
Pio e Tito Toso, 2018

EN — Ray is a freestanding coat stand that masterfully combines flowing lines, accentuating the beauty of the ash wood, with the functionality of an indispensable everyday object for a variety of interior spaces.

IT — Ray è un appendiabiti da terra, capace di sintetizzare in maniera ottimale una forma fluida, in grado di mettere in risalto la bellezza del frassino, e la funzionalità propria di un oggetto di uso quotidiano indispensabile all'interno di contesti diversi.



Coat stand

Appendiabiti da terra

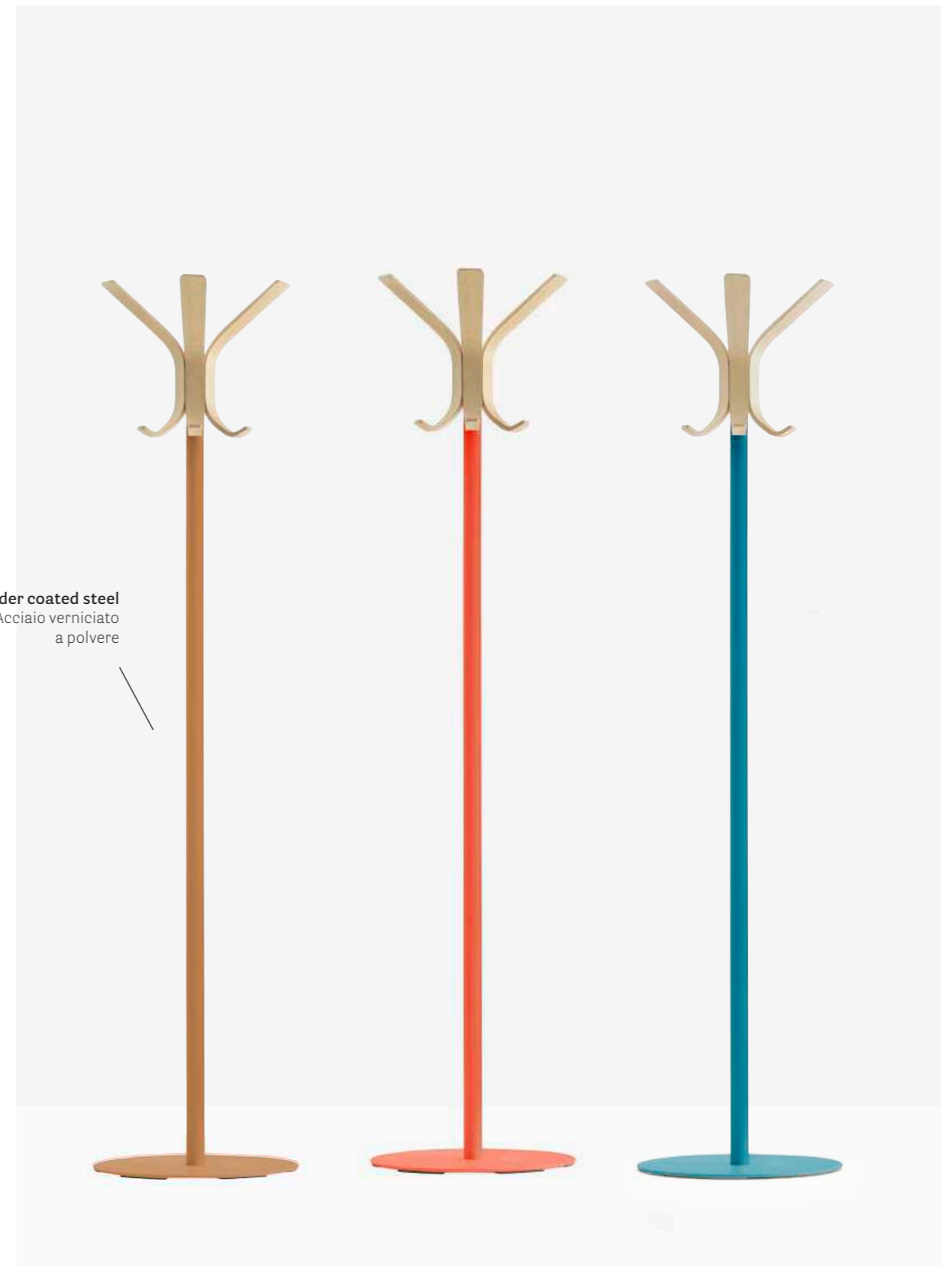



Variable thickness
plywood arms
Bracci in multistrato
a spessore variabile



#PedraliPalaceofWonders

Salone del Mobile.Milano 2019
Milan, Italy

Project: Exhibition stand
Architect: CalviBrambilla
Products: Ray coat stand,
Elinor table, Ester armchair



5166

Coat stand, steel stem
and ash wood hooks

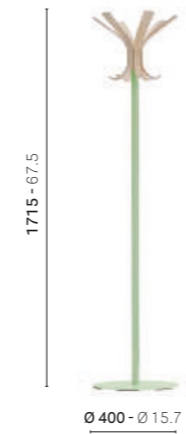

FINISHES / FINITURE

lacquered ash with visible grains
frassino laccato a poro aperto

coated ash
frassino verniciato

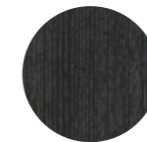

AN
Black
Nero



FR
Bleached ash
Frassino sbiancato



N1
Light walnut
Noce chiaro

powder coated / verniciato

→ see booklet for finishes
vedi catalogo finiture



Pedrali Poetry of Elements

Orgatec 2018
Cologne, Germany

Project: Exhibition stand

Architect: CalviBrambilla

Product: Ray coat stand, Nym side chair and armchair,
Arki-Table, Snooze sound absorbing panel

Flag

Hang up your ideas

DESIGN
Pio e Tito Toso, 2014

EN — Flag is a collection of coat stands and wall coat hangers that are the result of the synthesis between form and function. The base and column are made of powder-coated steel, while the hooks are made of polypropylene charged with fiberglass. Flag can adapt to various contexts: public spaces, offices as well as domestic environments.

IT — Flag è una collezione di appendiabiti frutto della sintesi di forma e funzione. La base e la colonna sono in acciaio verniciato, mentre i ganci sono realizzati in polipropilene caricato fibra di vetro. Flag si adatta a molteplici contesti: dagli spazi pubblici, agli uffici, agli ambienti domestici.



WAITING

Coat stand appendiabiti Flag
Umbrella stand portaombrelli Brik



WORKSPACE

Coat hanger appendiabiti Flag Wall
Umbrella stand portaombrelli Brik
Armchair poltrona Laja
Table tavolo Arki-Table

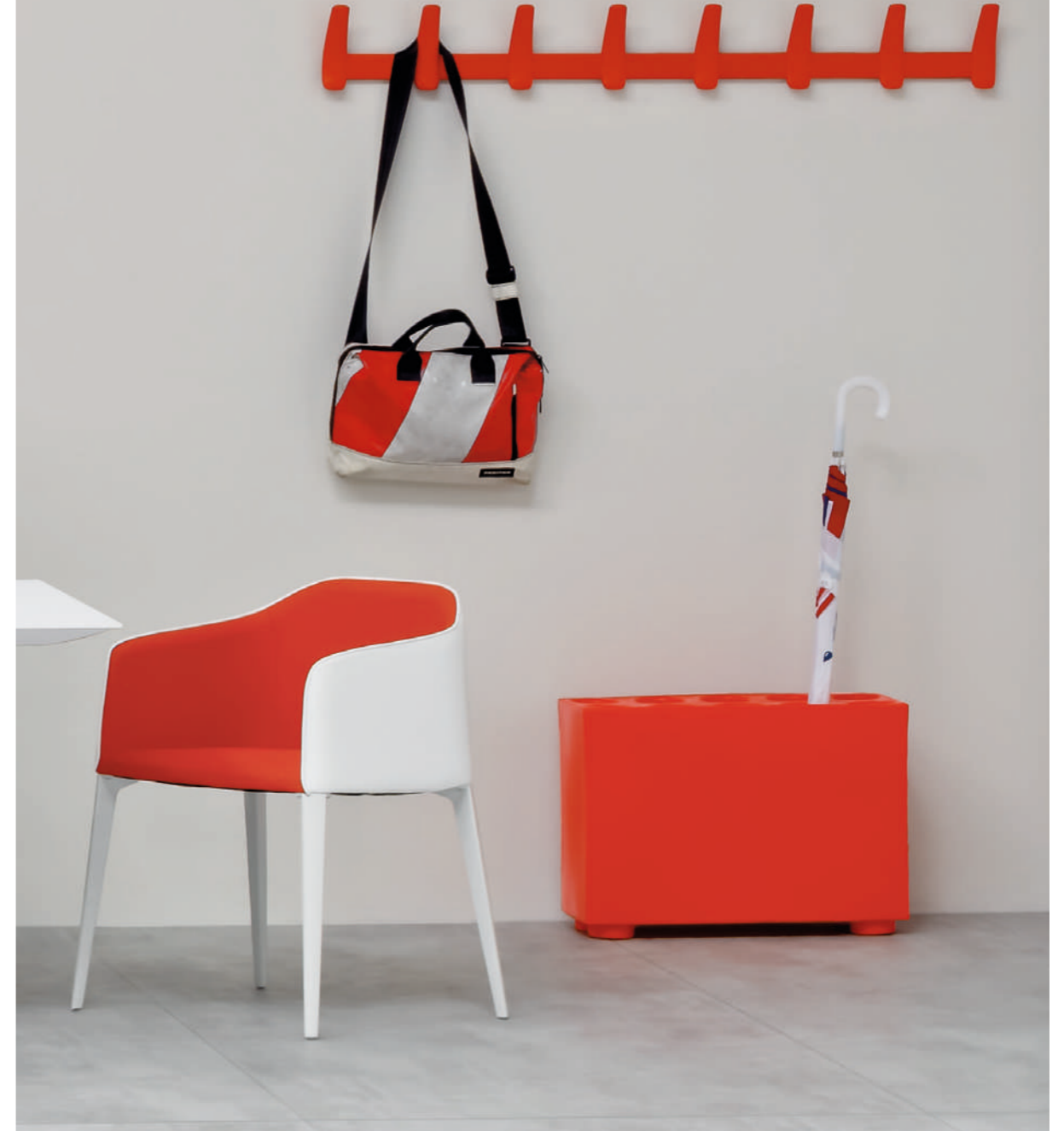

Coat stand

Appendiabiti da terra

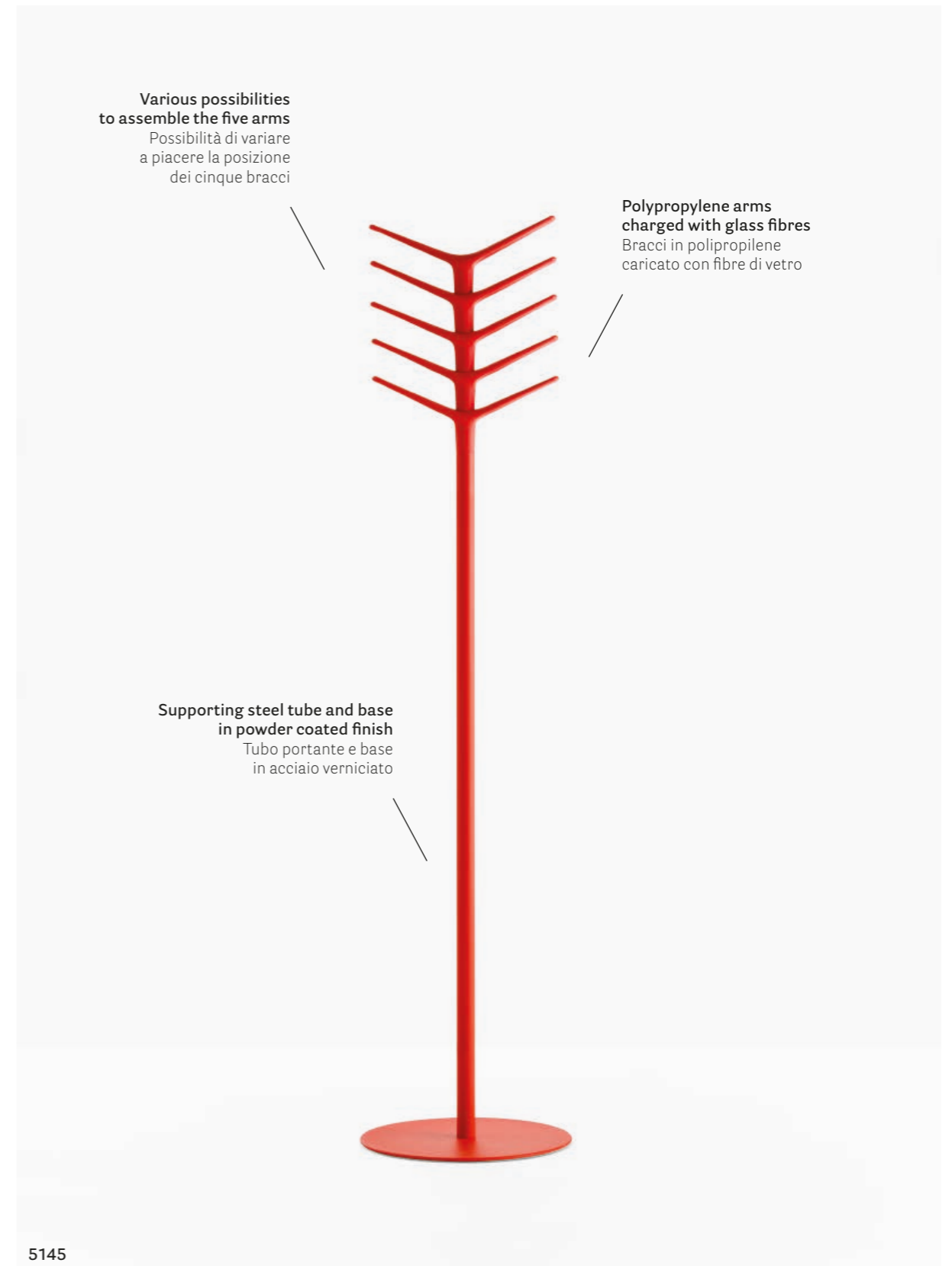
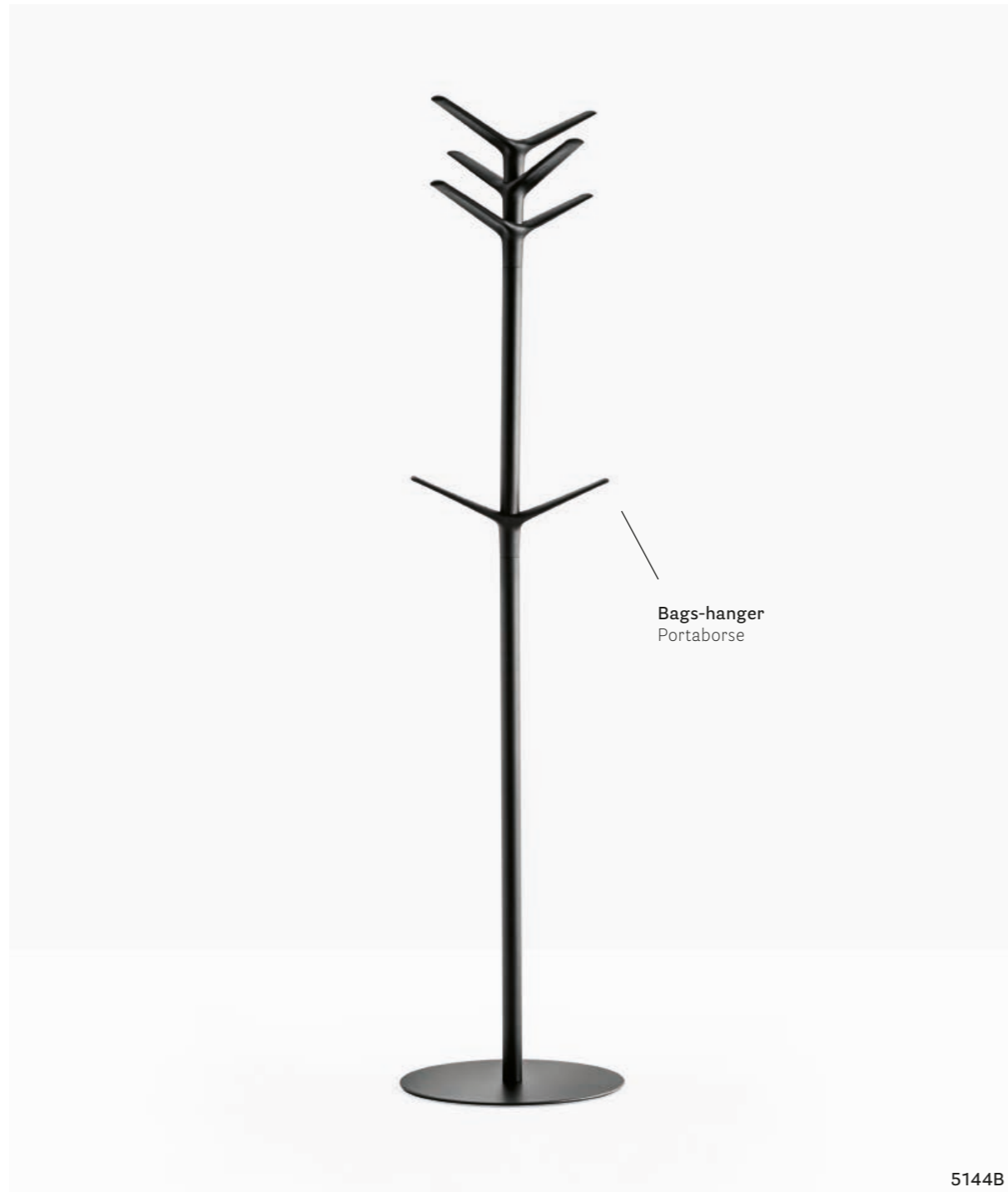

Coat hanger

Appendiabiti da parete

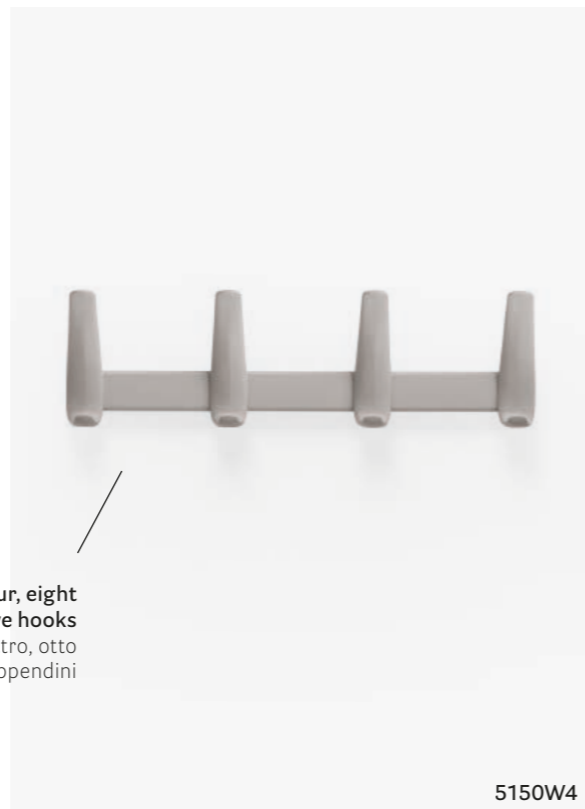

Four, eight
or twelve hooks
Quattro, otto
o dodici appendini

5150W4

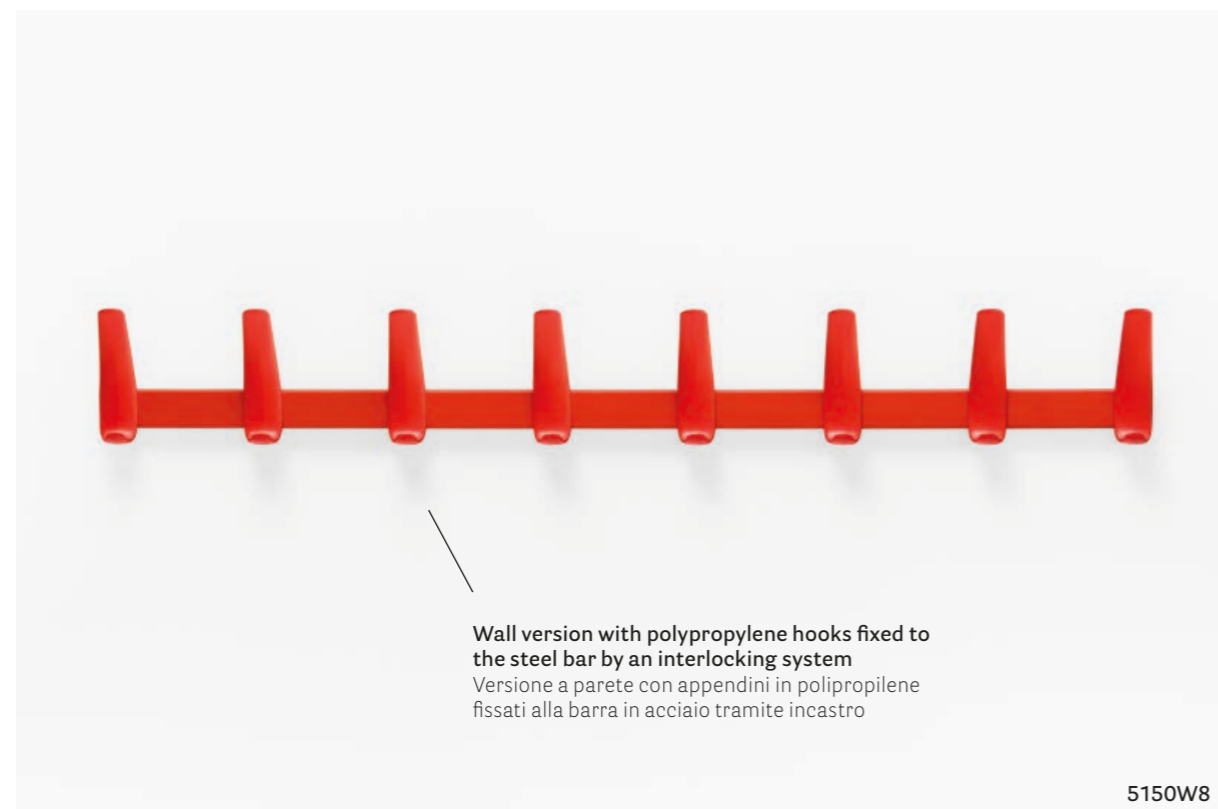

Wall version with polypropylene hooks fixed to
the steel bar by an interlocking system
Versione a parete con appendini in polipropilene
fissati alla barra in acciaio tramite incastrò

5150W8



Expo Sistema Bergamo

Expo Milano 2015
Milan, Italy

Project: Temporary installation
Architect: Francesca Perani
Products: Flag coat stand,
Zippo modular seating,
Tweet armchair, Arki-Table,
Stylus table, Ara Lounge armchair,
Wow pouf



Private Office

Desenzano del Garda, Italy

Project: Office
Products: Flag coat stand,
Arki-Table, Tweet side chair



Unit 4

Stockholm, Sweden

Project: Office

Products: Flag coat hanger, Noa armchair

5145
Coat stand, steel bar
and polypropylene arms

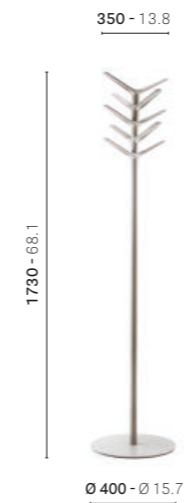

5144B
Coat stand, steel bar
and polypropylene arms

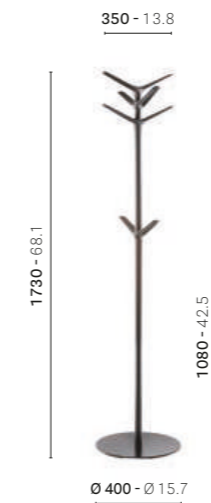

5141B
Bags-hanger, steel bar
and polypropylene arms



5150W4
Coat hanger, steel bar
and polypropylene hooks

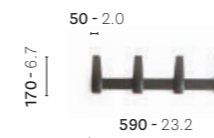

5150W8
Coat hanger, steel bar
and polypropylene hooks

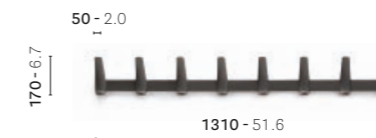

5150W12
Coat hanger, steel bar and polypropylene hooks

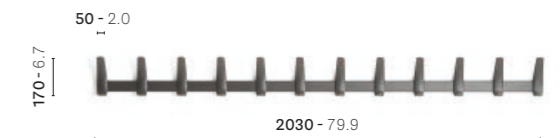

FINISHES / FINITURE

polypropylene and powder coated steel / polipropilene e acciaio verniciato

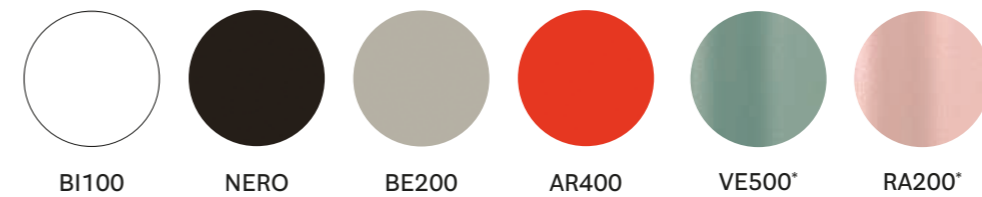

*for coat stand / per appendiabiti da terra

Snooze

Sound wellness

DESIGN
Marcello Ziliani, 2016

EN— Snooze is a sound absorbing panel conceived to enhance comfort and improve the acoustic quality in office or public space. With a shape recalling the sound diffusers, it is composed by a core of thermoformed polyester fiber in variable densities and thicknesses with a central metal element that beside being a graphic sign allows an easy assembly and disassembly. It is possible the set-up of panels on the walls and on ceilings in groups or linear compositions.

IT— Snooze è un pannello fonoassorbente creato per rendere più accogliente e migliorare la qualità acustica di uffici e spazi pubblici. Con una forma che ricorda i diffusori acustici, è costituito da un'anima in fibra di poliestere termoformato di densità e spessore variabili con al centro un elemento metallico che, oltre ad essere un segno grafico, ne permette una facile installazione e disassemblaggio. Si può disporre su pareti e su soffitti con composizioni lineari o a gruppi.



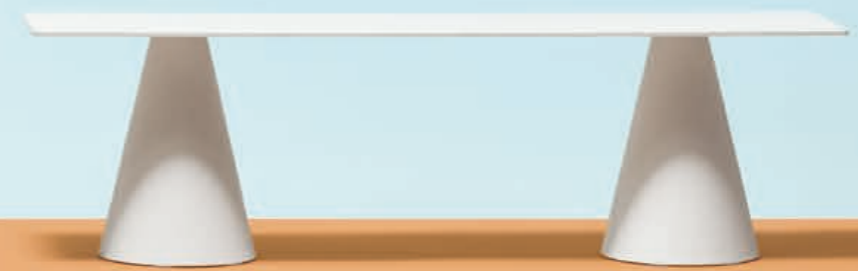

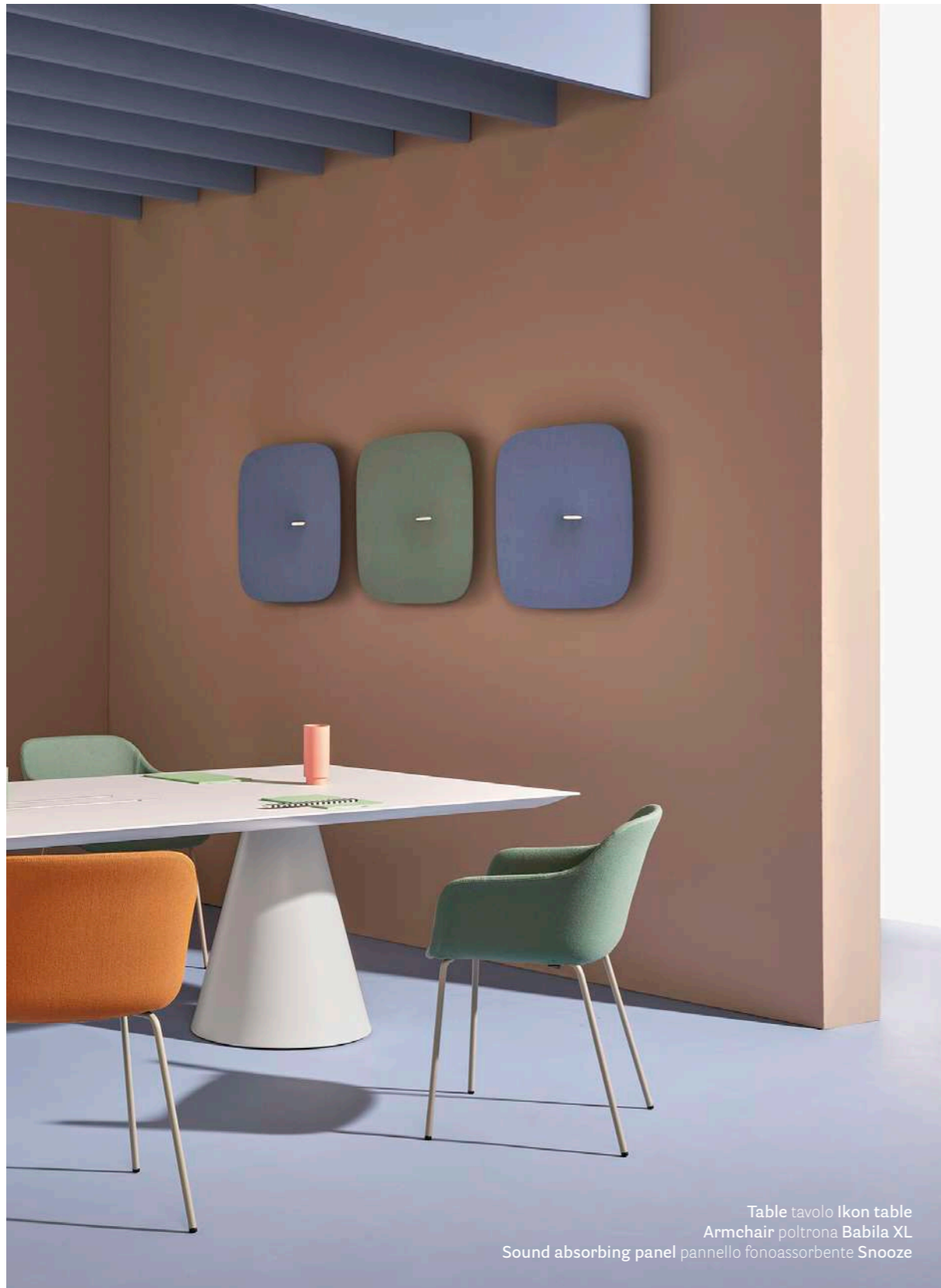

**Sound
absorbing panel**
Pannello
fonoassorbente

Removable covering,
available in different fabrics
Rivestimento sfoderabile,
disponibile in diversi tessuti

Thermoformed
polyester fiber core
Anima in fibra di
poliestere termoformato



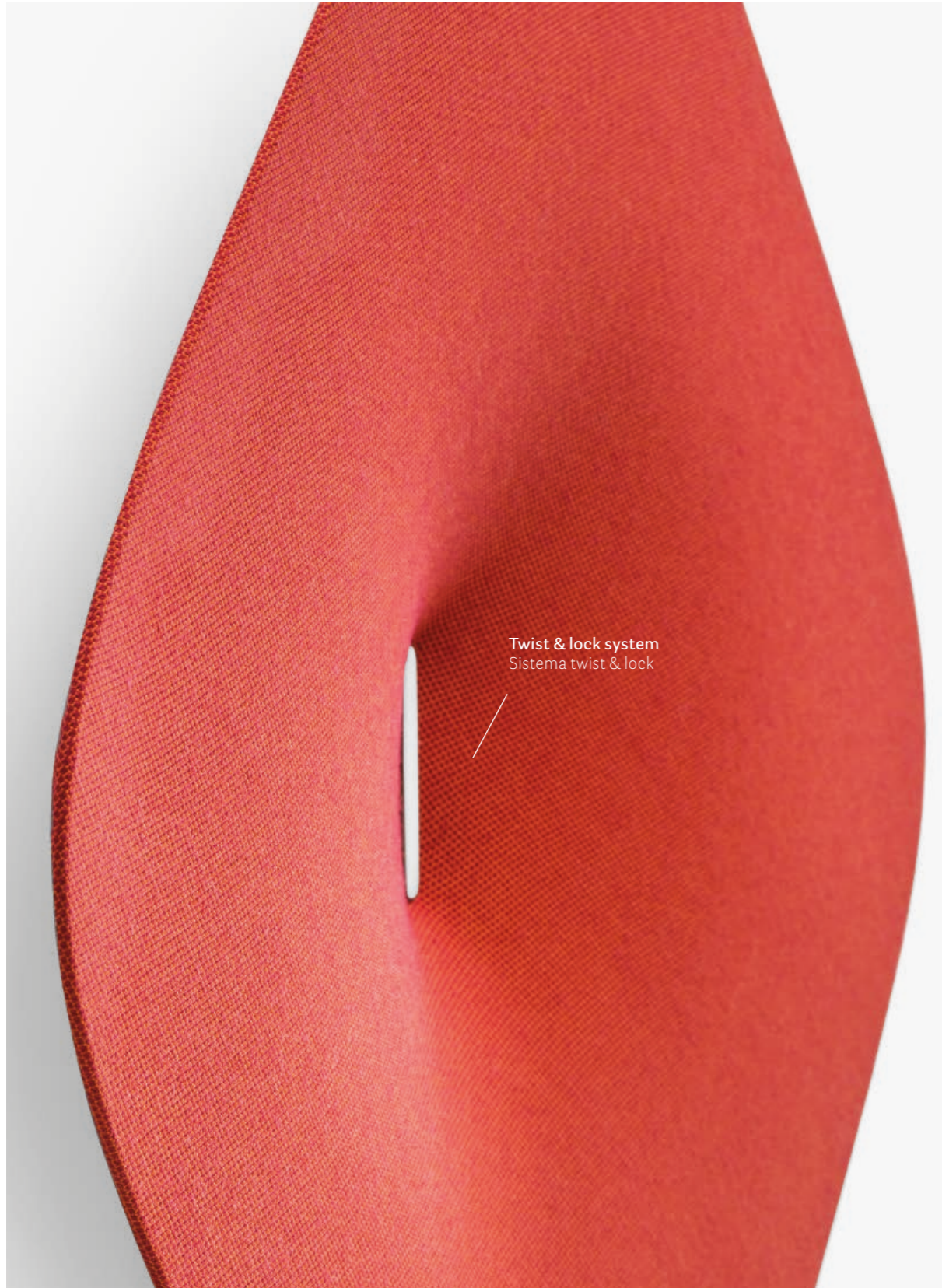

Treuhand Union Steuerberatung GMBH Salzburg

Salzburg, Austria

Project: Office

Architect: Mutant Arch.Media

Products: Snooze sound absorbing panel,
babila barstool, Inox table





Iron Office

Orgatec 2016
Cologne, Germany

Project: Exhibition stand

Architect: CalviBrambilla

Product: Snooze sound absorbing panel,
Tweet side chair and barstool



MUG - Magazzini Generativi

Bologna, Italy

Project: Co-working space

Architect: Sebastiano Longaretti, Mattia Sullini and Andrea Cattabriga

Products: Laja armchair, Arki-Table, Snooze sound absorbing panel

SNZ01P

Sound absorbing panel



EXAMPLES OF COMBINATIONS / ESEMPI DI CONFIGURAZIONI

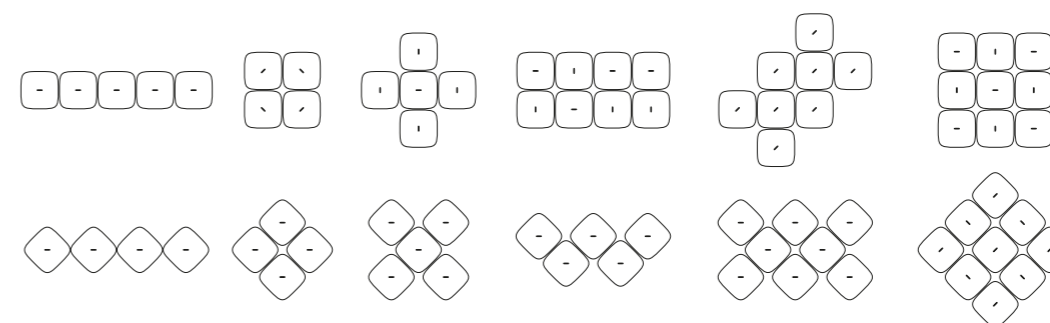

FINISHES / FINITURE

aluminium / alluminio

fabrics / tessuti



ST
Satinized
Satinato

→ see booklet for finishes
vedi catalogo finiture



CERTIFICATIONS / CERTIFICAZIONI

EN ISO 354:2003 Reverberation rooms - Sound test
EN ISO 354:2003 Camera riverberante, test acustico

IMQ CERTIFICATE / CERTIFICATO IMQ
Test report 0056\DC\ACU\17_1 / Rapporto di prova 0056\DC\ACU\17_1

UNI EN ISO 11654:1998 Rating of sound absorption
UNI EN ISO 11654:1998 Valutazione dell'assorbimento acustico

Giravolta

The wireless outdoor lighting

DESIGN

Alberto Basaglia - Natalia Rota Nodari, 2017

EN — Inspired by Lanterns of times past, it is a wireless lighting distinguished by a contemporary design and suitable for outdoor environments. The name reflects its essence: the swivelling diffuser and the rechargeable feature recalls the great inventor Alessandro Volta and his main discovery, the battery.

IT — Ispirata alle lanterne di un tempo, Giravolta è una lampada wireless ricaricabile dal design contemporaneo, adatta per l'outdoor. Nel nome tutta la sua essenza: da un lato il suo diffusore orientabile, dall'altro il suo essere ricaricabile da cui il riferimento ad Alessandro Volta e alla sua principale invenzione, la pila.



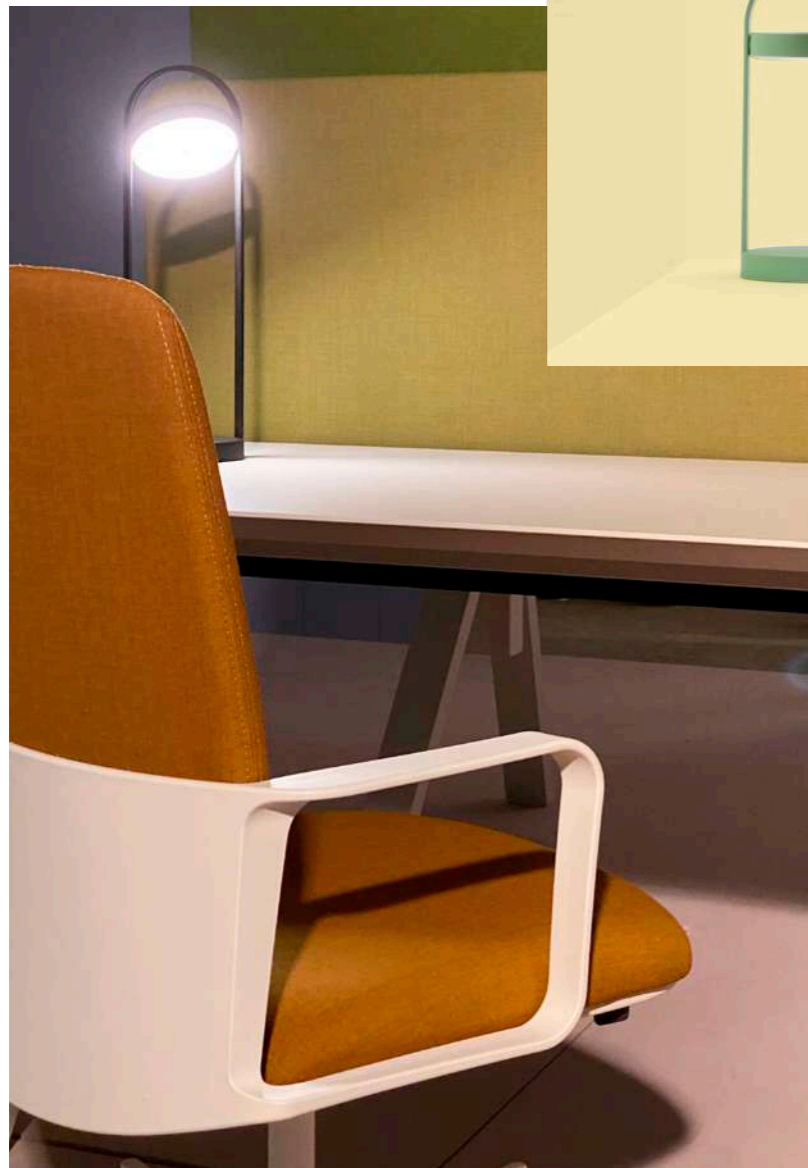
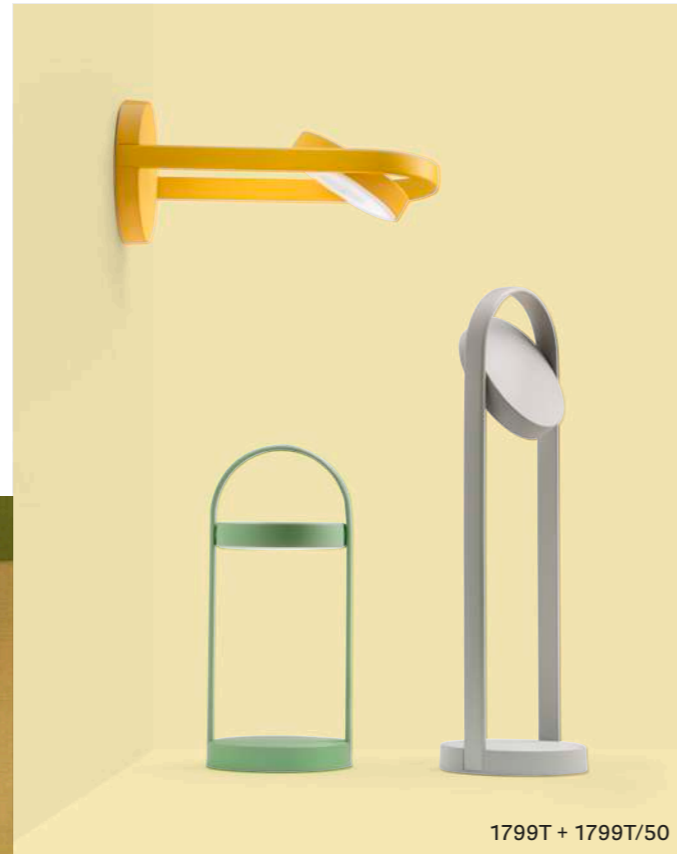

Lighting lampada Giravolta
Storage system Sistema contenitore Boxie
Table tavolo Arki-Desk
Armchair poltrona Babila XL

Pedrali Workspace | Edition 2025

Copyright © 2025, Pedrali S.p.A. All rights reserved

Photo credits

BHM Studio
Beppe Brancato
Andrea Garuti
Mattia Pagani
Ottavio Tomasini

Adrien Williams
Alain Intraina
Alexander Bogorodsky
Andrew Shustykevych
Andrey Avdeenko
Anja Longyka
Buro Project x Anthony
Boelaert
Celeste Cima
Dario e Carlos Tettamanzi
David Lahnsteiner x MAM
Architects

Davide Galli
Ema Peter
Fabio Bascetta
Fernando Alda
Frank Jankowski
Gareth Gardner
George Palov
Geraldine Bruneel
Germano Borrelli
Gidon Levin and 181 Maalot
Gwenaëlle Hoyet
Helenio Barbeta
Hiepler and Brunier
JAG Studio photographer
Jared Chulski
Jason Strong
Jesus Romero De Luque
José Campos

Kareem-Olivier
Lea Martin
Lorenzo Burlando
Marc Torra
Maria Eugenia Mârquez - MXM
Maria Salvi
Martin Metelko
Matteo Sturla
Matteo Vercelloni
Michael Baumgartner
Michele Morosi
Minko Minev
Nicole England
Oscar Mata
PaganiBros
Peter Wuermli
Priyanka Vohra Anand
Rebecca Reid

René Gonkel
Sara Magni
Simone Furiosi
Simone Ronzio
Spacesandplaces.pt
Tine Brans
Uzi Porat

Thanks to
Studio FM

Styling
Studio Salaris
Elena Caponi
Sissi Valassina
Elena Mora



The mark of
responsible forestry

Look for FSC™ certified products
Cerca i prodotti certificati FSC™



Look for GREENGUARD certified products
Cerca i prodotti certificati GREENGUARD



Look for CATAS certified products
Cerca i prodotti certificati CATAS

Pesi, dimensioni e colori sono indicativi. Pedrali si riserva la facoltà di apportare modifiche o migliorie senza alcun preavviso.
Weights, measurements and colours are indicative. Pedrali reserves the right to modify or upgrade the products without prior notice.

Industrial property right | Diritto di proprietà industriale

I contenuti del presente catalogo, quali, a titolo esemplificativo, le opere, le immagini, le fotografie, i documenti, i disegni, le figure, i loghi ed ogni altro materiale, in qualsiasi formato, pubblicato sono protetti a livello mondiale dal diritto d'autore e da ogni altro diritto di proprietà intellettuale di PEDRALI.
The contents of the present catalogue such as, by way of example, the works, the images, the pictures, the documents, the drawings, the forms, the logos and all other materials, published in any format, are worldwide protected by copyrights and any other industrial intellectual property right of Pedrali.