

S 25



 **bralco**
the next office

Index



Gate

p. 5

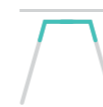

Polare

p. 29



Winglet^e
Winglet^{push}
Winglet
Winglet^r

p. 47
p. 64
p. 66
p. 68



schermi e gonne · screens and modesty panels ·
écrans et voiles de fond · Sichtschutzpaneele und
Knieraumblende · pantallas y faldones

p. 78



elettrificazione · electification · électrification ·
Elektrifizierung · electrificación

p. 83



finiture e colori · finishing and colors · finitions et couleurs ·
Oberfläche und farben · acabados y colores

p. 89

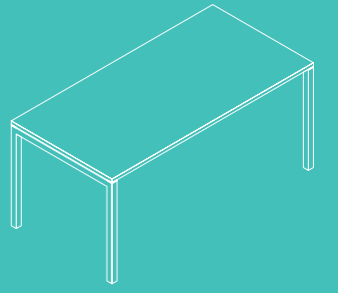

GATE

design:
Gianantonio Perin
Giorgio Topan

**Essenziale e contemporaneo.
Flessibile e riconfigurabile. Gate racconta
attraverso forme essenziali e contemporanee
un nuovo concetto di funzionalità.**

Essential and contemporary.
Flexible and reconfigurable. Gate tells
through essential and contemporary forms
a new concept of functionality.

Essentiel et contemporaine.
Flexible et reconfigurable. Gate raconte
à travers des formes essentielles et contemporaines
un nouveau concept de fonctionnalité.

Notwendig und zeitgenössisch.
Flexibel und Rekonfigurierbar. Gate erzählt durch
seine Linearen und zeitgenössische Formen
ein Neuer Konzept der Funktionalität.

Esencial y contemporáneo.
Flexible y reconfigurable. A través
de sus formas esenciales y contemporáneas,
Gate presenta una nueva idea de funcionalidad.

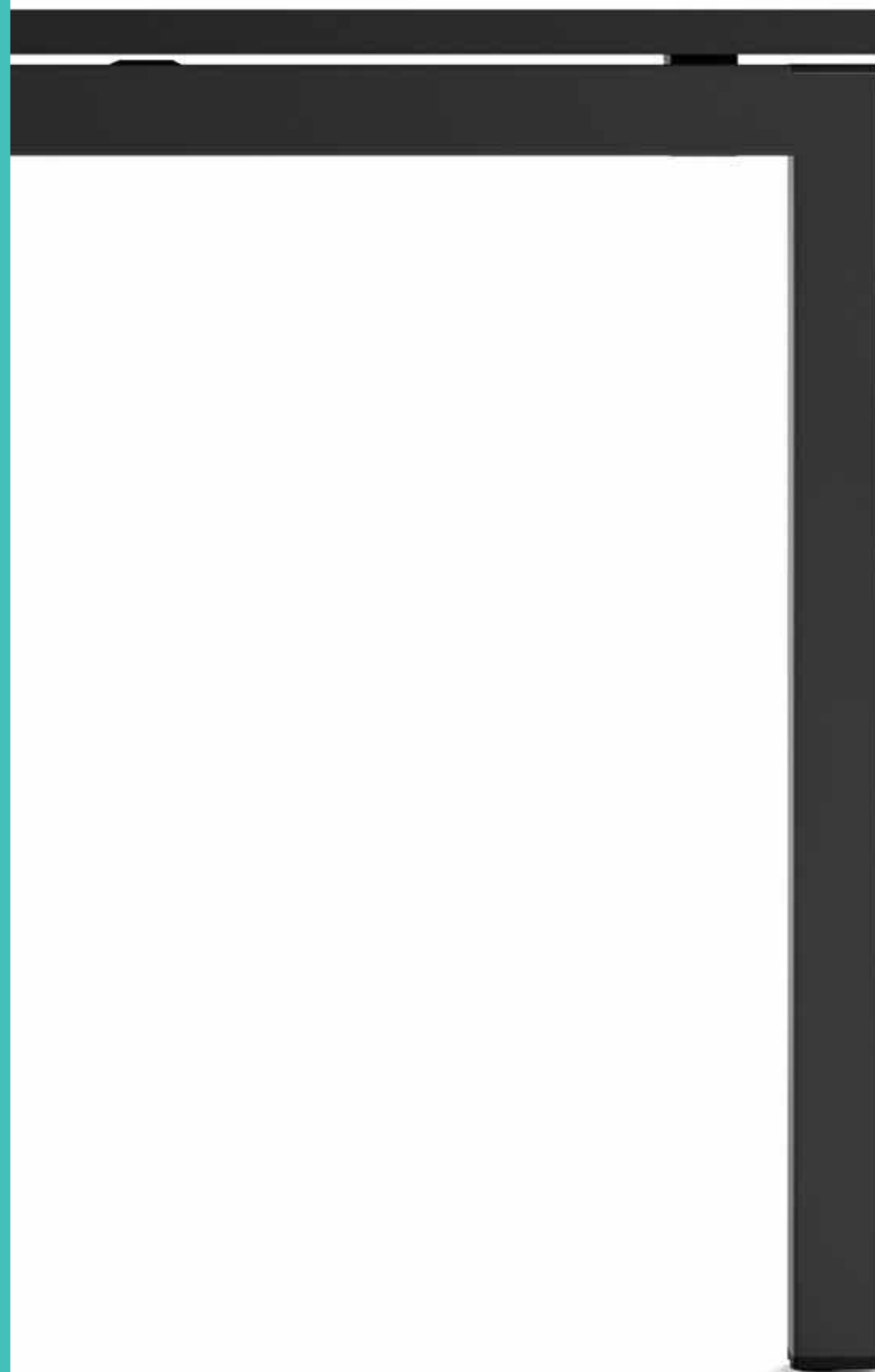

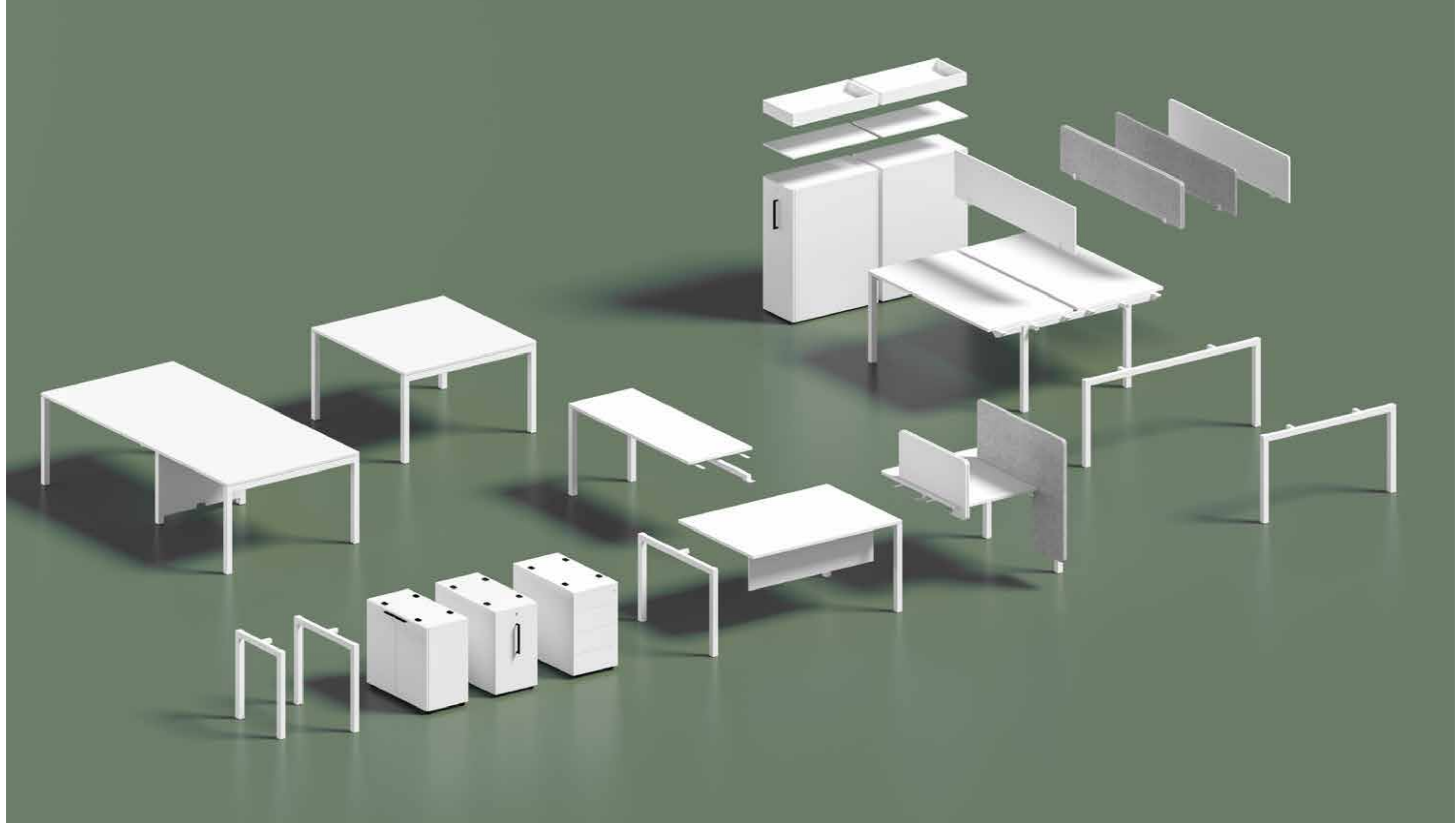















I tavoli Gate, disponibili in diverse forme e colori, si integrano perfettamente agli altri prodotti della collezione.

The Gate tables, available in different shapes and colors, integrate perfectly the other products of the collection.

Les tables Gate, disponibles en différentes formes et couleurs, s'intègrent parfaitement aux autres produits de la collection.

Die in verschiedenen Formen und Farben erhältlichen Gate-Tische fügen sich perfekt in die anderen Produkte der Kollektion ein.

Las mesas Gate, disponibles en diferentes formas y colores, se integran perfectamente con el resto de productos de la colección.





accessori • accessories • accessoires • Zubehör • accesorios



elettrificazione • electrification • électrification • Elektrifizierung • electrificación

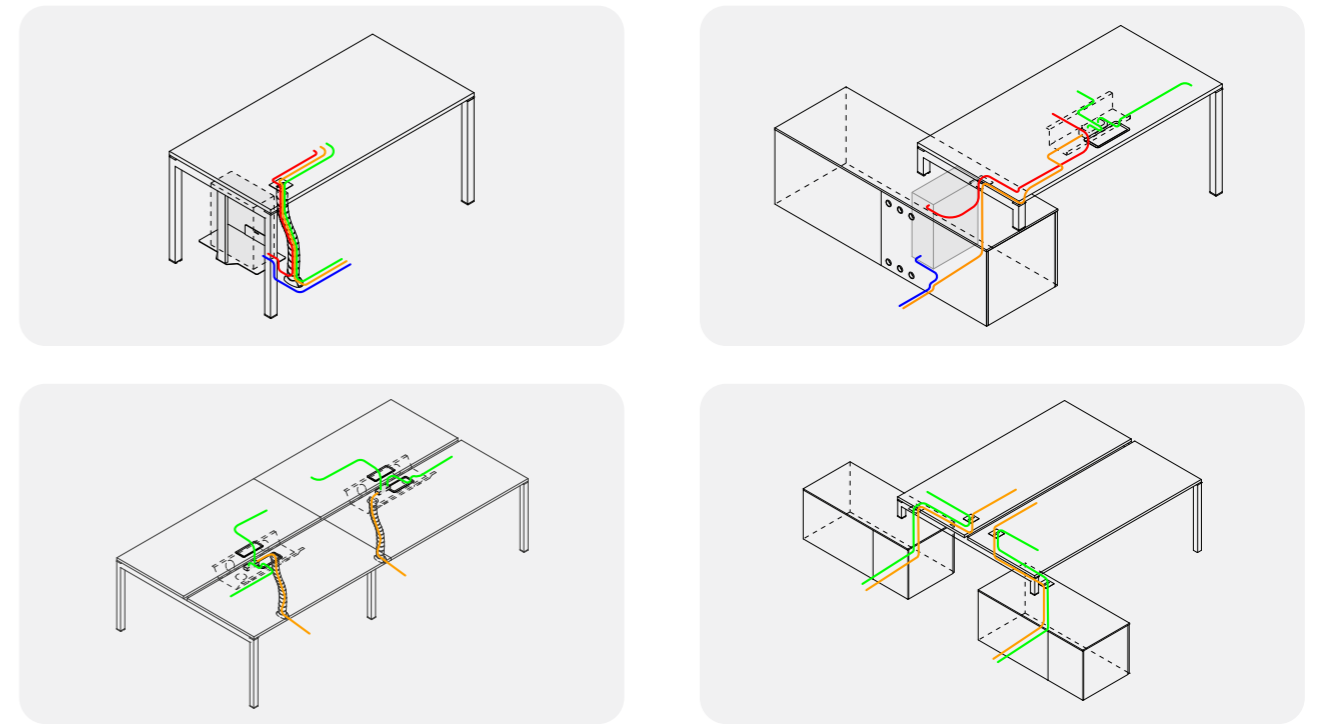

finiture • finishes • finitions • Ausführungen • acabados

numero finiture, number of finishes, numéro de finitions, Anzahl der Ausführungen, numero de acabados

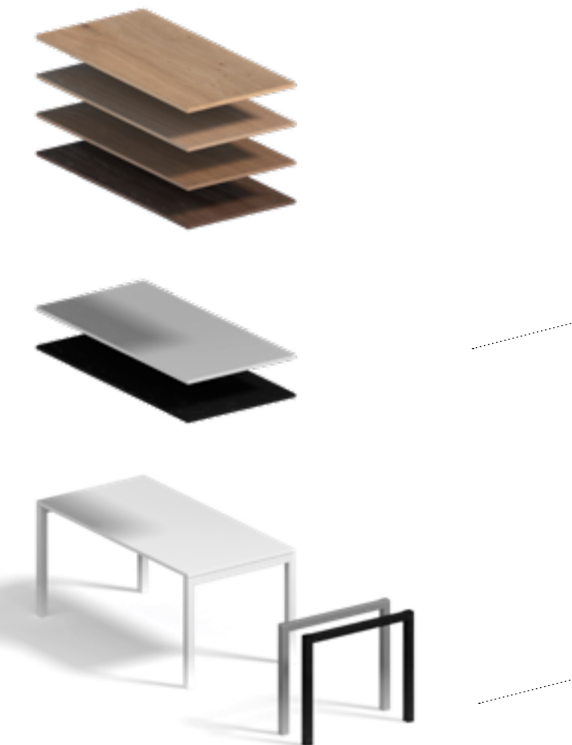

7

melaminico, melamine, mélamine, melamin, melamina



*h: 30 mm

3

metallo, metal, métal, Metall, metal

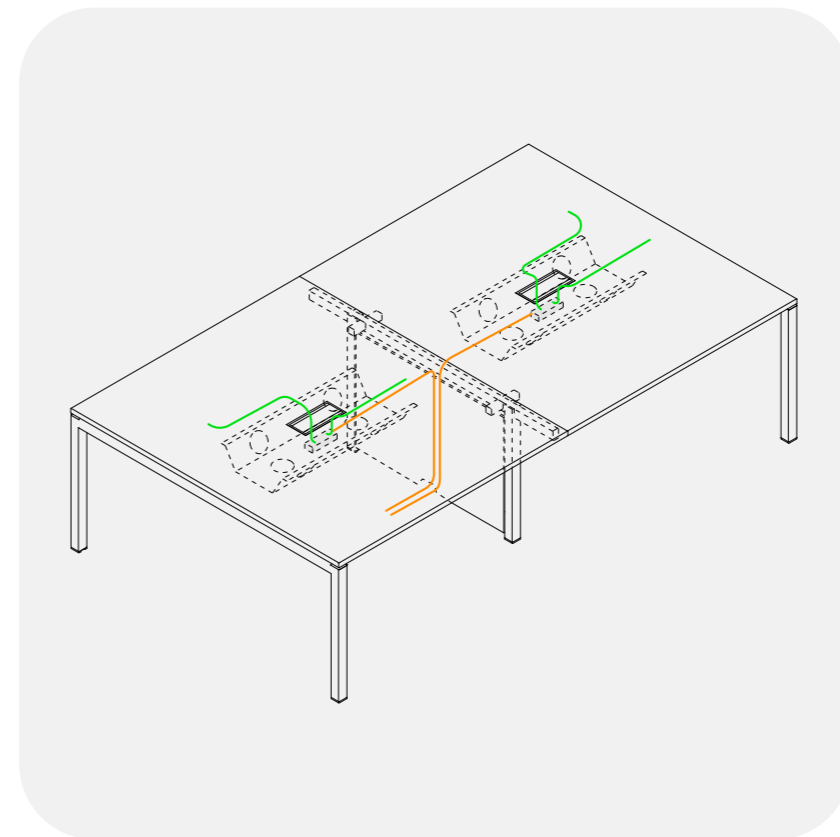



h: 74 cm

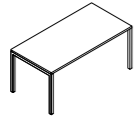

w 80÷200* cm
d 60 - 80 cm

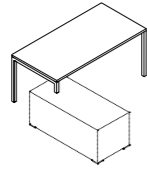

w 140÷200* cm
d 80 cm

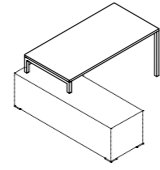

w 140÷200* cm
d 80 cm

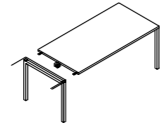

w 60÷200* cm 80÷200* cm
d 60 cm 80 cm

*** w. 200 cm anche con d. 100 cm**
w. 200 cm also with d. 100 cm
w. 200 cm également avec p. 100 cm
w. 200 cm auch mit T. 100 cm
w. 200 cm también con p. 100 cm

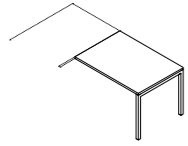

w 60÷120 cm
d 60 cm

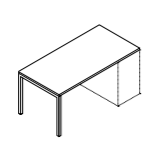

w 120÷200 cm
d 60 - 80 cm

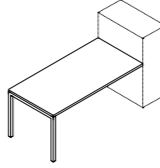

w 120÷200 cm
d 80 cm

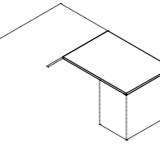

w 80÷120 cm
d 60 cm

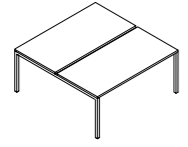

w 140÷200 cm
d 124 - 164 cm

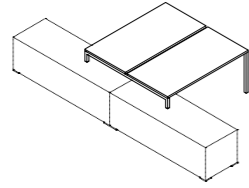

w 140÷200 cm
d 124 - 164 cm



w 140÷200 cm
d 124 - 164 cm

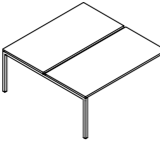

w 140÷200 cm
d 124 - 164 cm



w 124 cm 164 cm
d 60 cm 80 cm

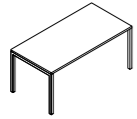

w 200 cm
d 100 cm

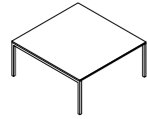

w d 80 - 124 - 164 cm

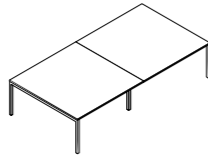

w 248 cm
d 124 cm

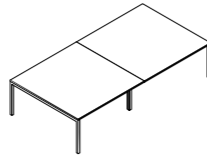

w 328 cm
d 164 cm



w 240 cm
d 124 cm

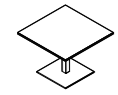

w d 80 - 100 - 124 cm

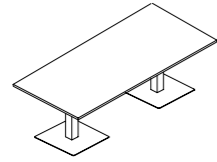

w 240 cm
d 124 cm

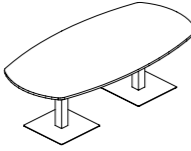

w 240 cm
d 120 cm



w 60 - 120 cm
d 60 cm

h: 40 cm

h: 75 cm

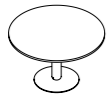

∅ 100 - 120 cm

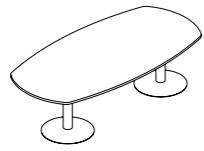

w 240 cm
d 120 cm

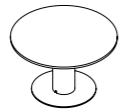

∅ 140 - 160 cm

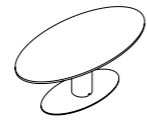

w 200 cm
d 104 cm

h: 74 cm



POLARE

design:
Gianantonio Perin
Monica Fernandes

**Un sistema modulare per vivere qualsiasi
soluzione nell'ambiente di lavoro
con l'atmosfera ed il calore di casa.**

A modular system to experience many
solutions in collaborative offices
with the atmosphere of home.

Un système modulaire pour vivre chaque
solution de travail avec l'atmosphère et la
chaleur de la maison.

Ein modulares System zum Erleben
jeder Lösung in der Arbeitsumfeld mit
die Atmosphäre und Wärme von zu Hause.

Un sistema modular para hacer cualquiera
solucion en el ambiente de trabajo con
atmosfera y calor del hogar.





Dai vita a un ambiente di lavoro accogliente e informale con i tavoli meeting e le panche dedicate Polare.

Create a welcoming and informal work environment with Polare meeting tables and dedicated benches.

Créez un environnement de travail accueillant et informel avec les tables de réunion Polare et les banquettes dédiées.

Schaffen Sie ein einladendes und informelles Arbeitsumfeld mit Polare-Besprechungstischen und speziellen Bänken.

Cree un ambiente de trabajo acogedor e informal con mesas de reuniones Polare y bancos especiales.







Elektrifizazione integrata, vasta gamma di contenitori ed accessori fanno di Polare un sistema funzionale e di design.

Integrated electrification, a wide range of storage and accessories make Polare a functional and design system.

L'électrification intégrée, une large gamme de conteneurs et d'accessoires font de Polare un système fonctionnel et design.

Eingebaut Elektrifizierung, eine breite Palette an Behältern und Zubehör machen Polare zu einem Funktions- und Designsystem.

La electrificación integrada, una amplia gama de contenedores y accesorios hacen de Polare un sistema funcional y de diseño.





accessori • accessories • accessoires • Zubehör • accesorios

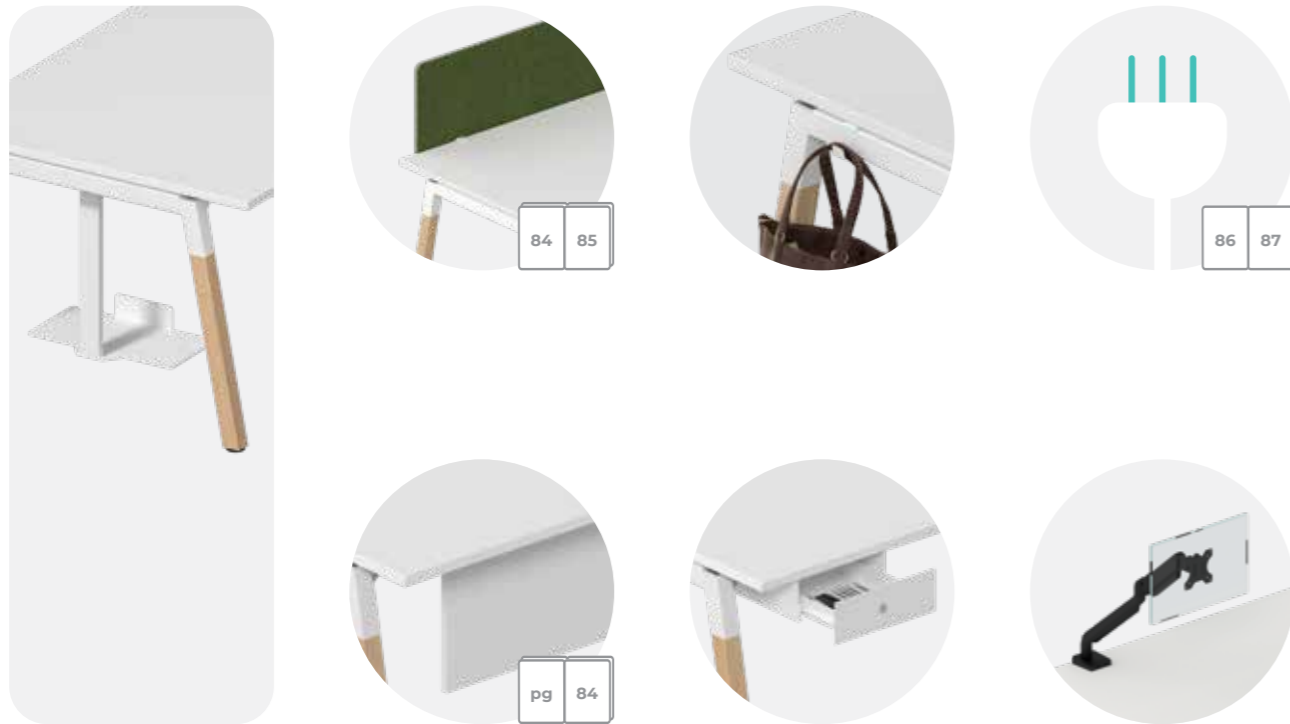

elettrificazione • electrification • électrification • Elektrifizierung • electrificación

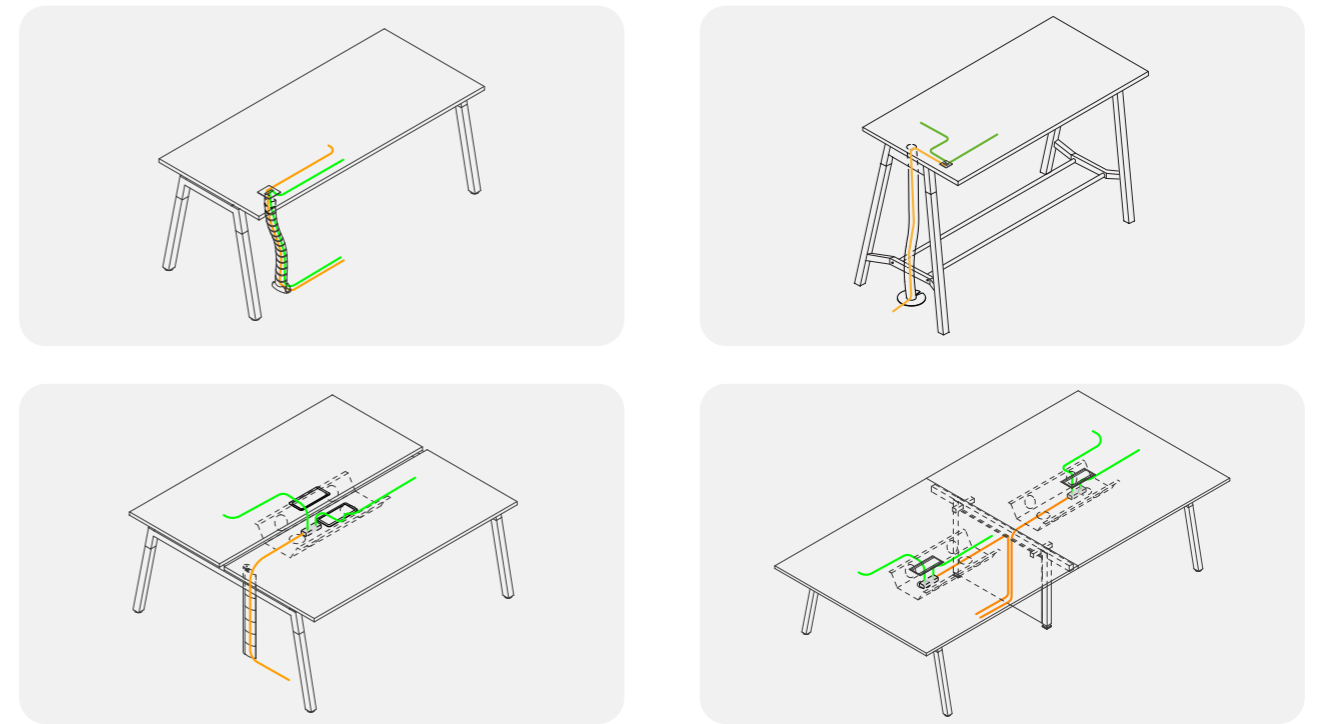

finiture • finishes • finitions • Ausführungen • acabados

numero finiture, number of finishes, numéro de finitions, Anzahl der Ausführungen, numero de acabados



3

melaminico, melamine, mélamine, melamin, melamina



2

metallo, metal, métal, Metall, metal

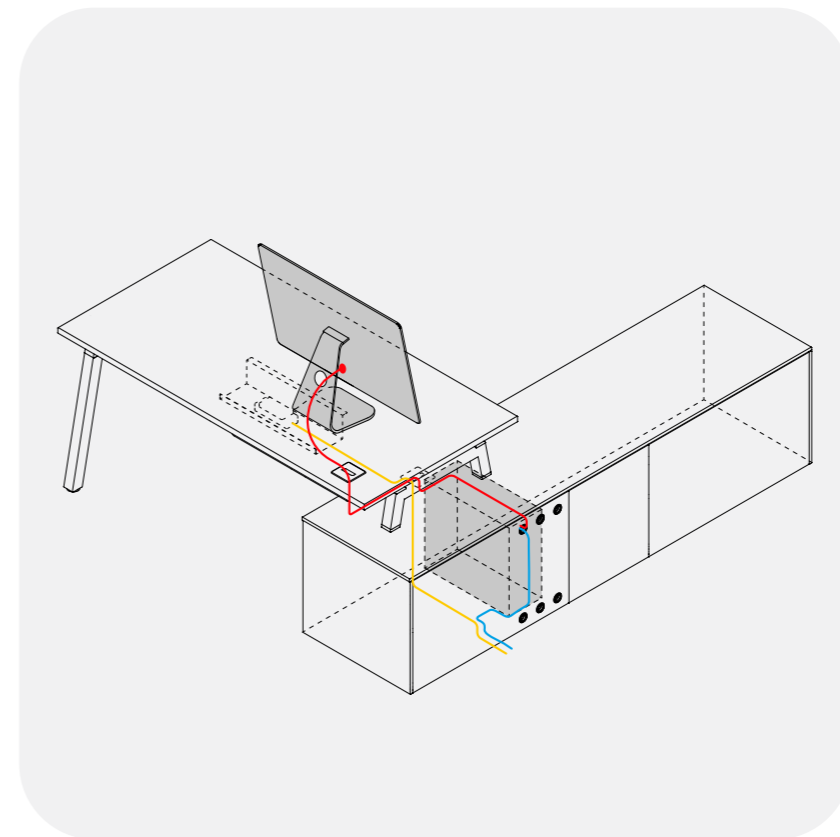



h: 74 cm



w 80÷200 cm
d 60 - 80 cm



w 140÷200 cm
d 80 cm

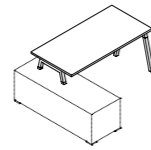

w 140÷200 cm
d 80 cm



w 60÷200 cm
d 60 cm



w 80÷200 cm
d 80 cm

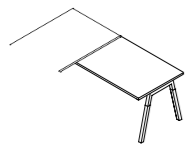

w 60÷120 cm
d 60 cm

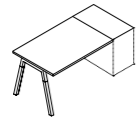

w 120÷200 cm
d 60 - 80 cm

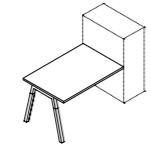

w 120÷200 cm
d 80 cm

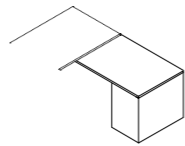

w 80 - 120 cm
d 60 cm

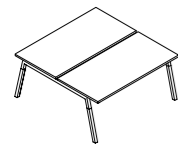

w 140÷200 cm
d 124 - 164 cm



w 140÷200 cm
d 124 - 164 cm

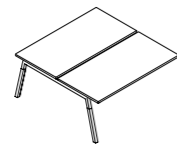

w 140÷200 cm
d 124 - 164 cm

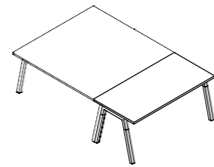

w 124 cm 164 cm
d 60 cm 80 cm

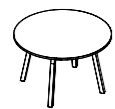

∅ 120 - 140 cm

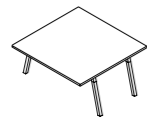

w d 164 cm

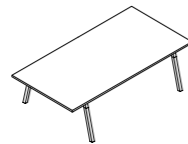

w 240 cm
d 124 cm

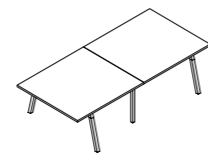

w 248 cm
d 124 cm

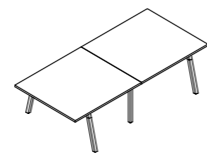

w 328 cm
d 164 cm

h: 44 cm

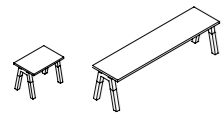

w 80 - 160 cm
d 40 cm



∅ 120 - 140 cm



w 140÷200 cm
d 80 cm

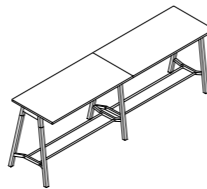

w 280÷400 cm
d 80 cm

h: 105 cm

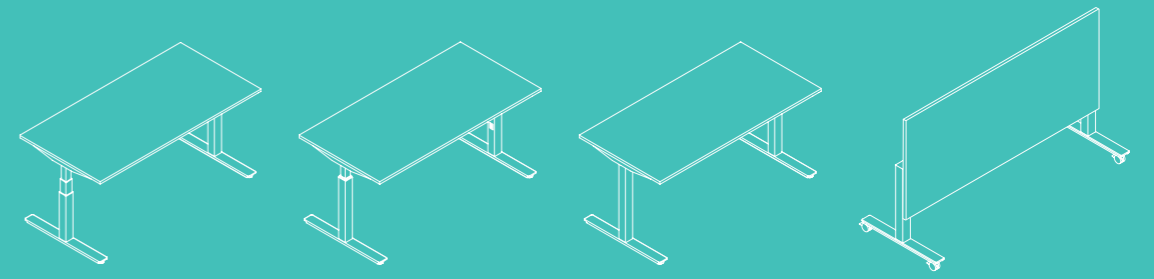

WINGLET *e*
WINGLET *push*
WINGLET
WINGLET *r*

design:
R&D Bralco

**Un sistema trasversale incentrato sull'ergonomia:
strutture con altezza fissa, variabile "push-button"
e regolabili elettriche "sit-stand".**

A cross-cutting office system focused on ergonomics:
structures with fixed height, variable "push-button"
and adjustable electric "sit-stand".

Un système transversal centré sur l'ergonomie :
structures avec hauteur fixe, réglable avec bouton
et électrique assis-debout.

Ein Quer System, bei dem die Ergonomie im Vordergrund steht:
Gestellen mit fester Höhe, höhenverstellbar "Push-knopf"
und elektrisch höhenverstellbarer "Steh-Sitz".

Un sistema transversal centrado en la ergonomía:
estructuras con patas fijas, regulables en altura
con pulsador o eléctricamente.

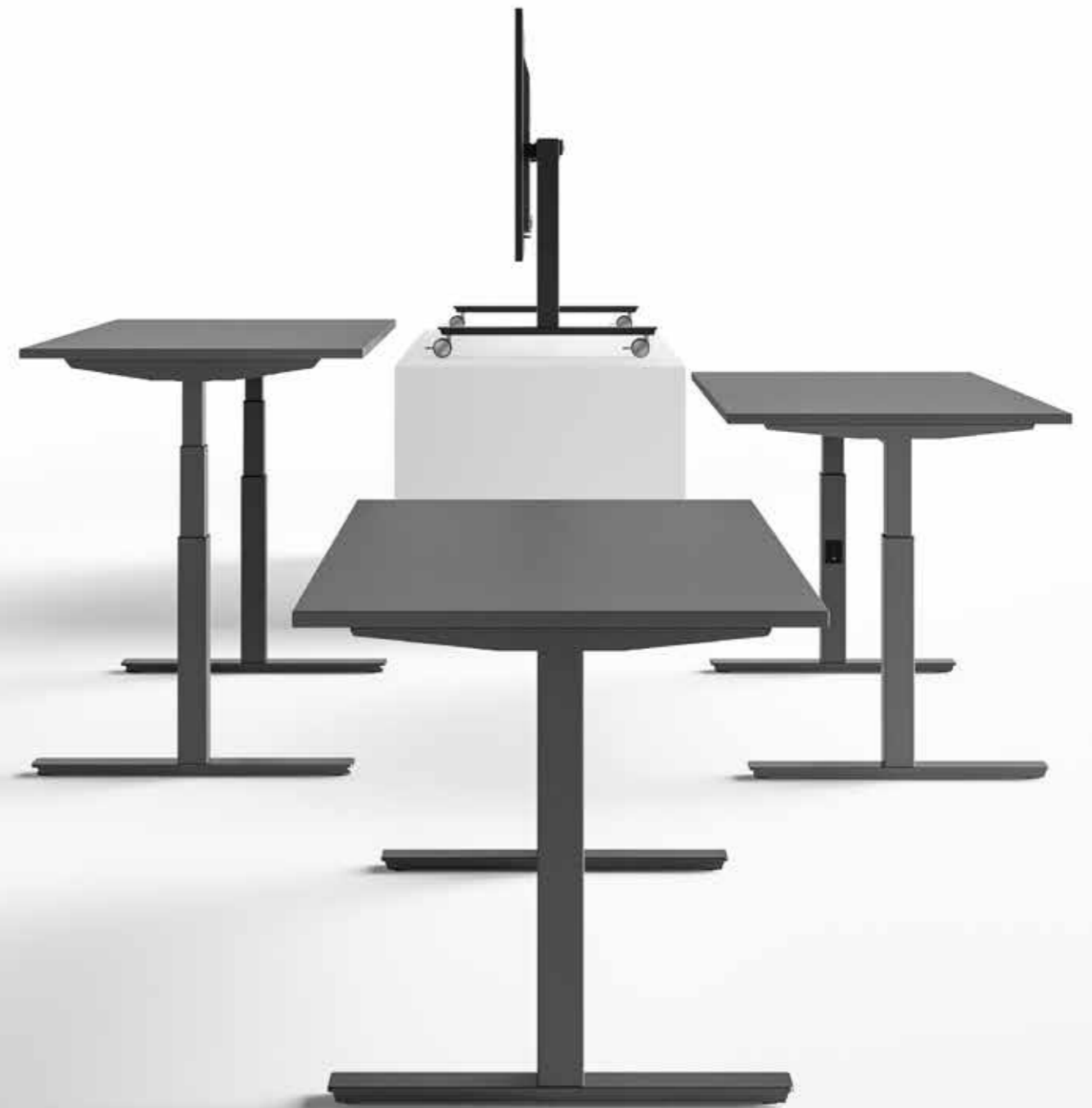

Winglet e

h 65 - 130



Winglet push

h 65 - 85



Winglet

h 74





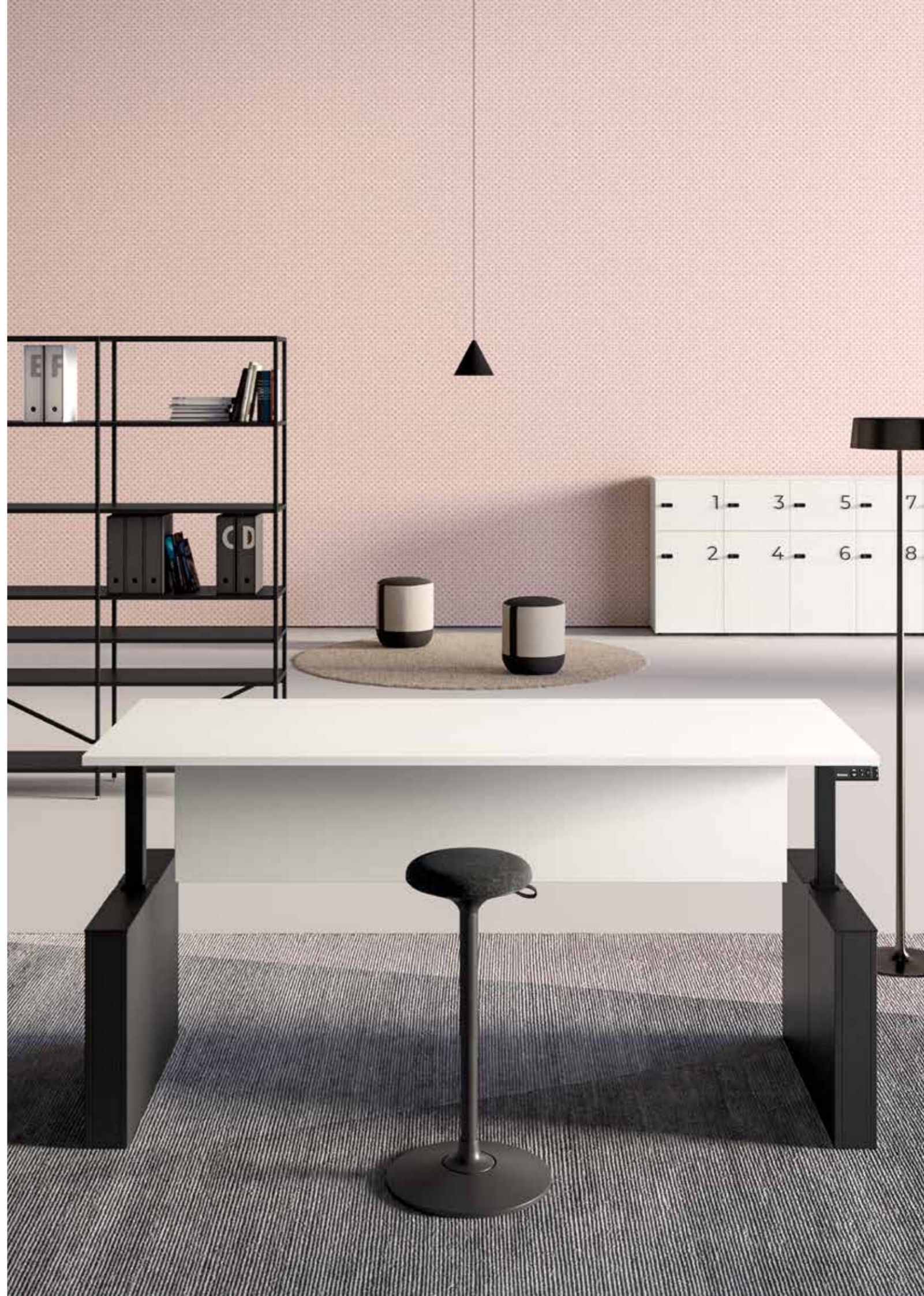





I bench della serie Winglet e sono disponibili in diverse configurazioni e finiture. Screen acustici dedicati.

The benches of the Winglet e series are available in different configurations and finishes. Dedicated acoustic screens.

Les bench de la série Winglet e sont disponibles en différentes configurations et finitions. Écrans acoustiques dédiés.

Die Bench der Winglet e-Serie sind in verschiedenen Kombinationen und Ausführungen erhältlich. Entsprechende Akustische Sichtschutzpaneelen.

Los bench de la serie Winglet e están disponibles en diferentes configuraciones y acabados. Pantallas acústicas exclusivas de esta serie.

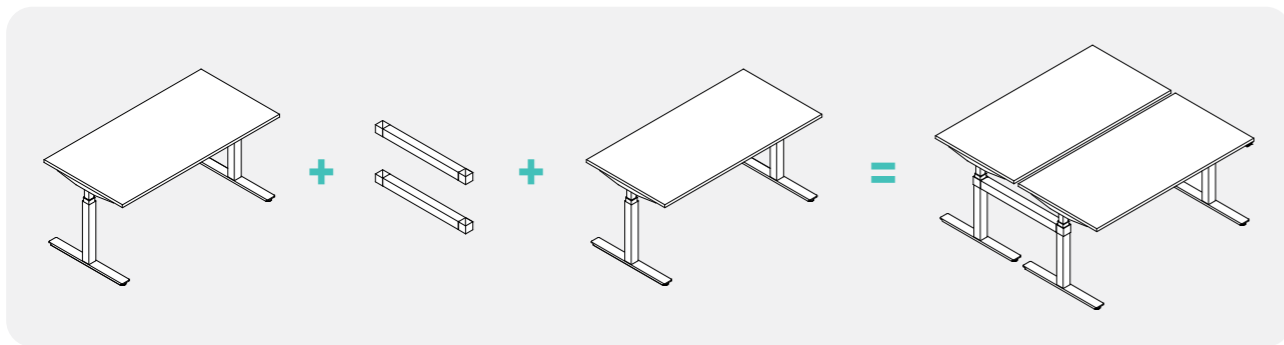
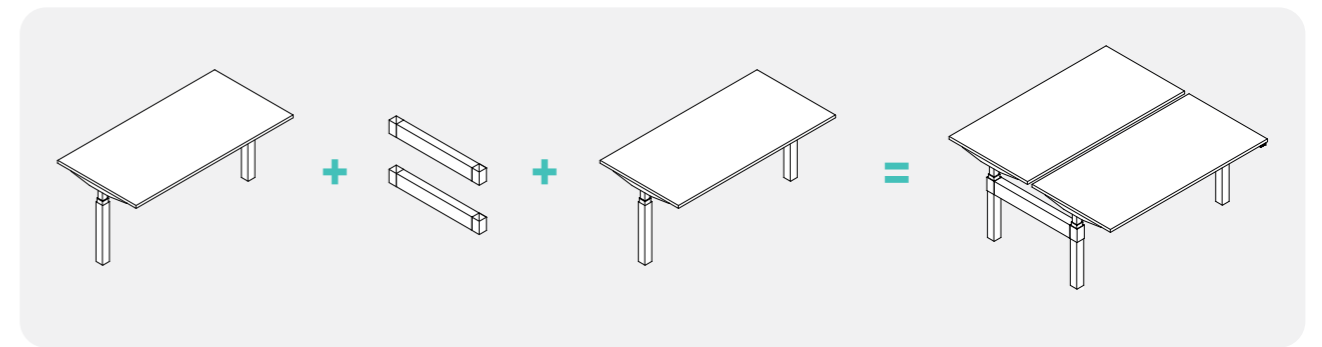









Winglet r

I tavoli Winglet ribaltabili su ruote permettono di riconfigurare gli spazi meeting multifunzionali insieme al display / lavagna Flipper.

The folding Winglet tables on wheels allow you to reconfigure multifunctional meeting spaces together with Flipper display / whiteboard.

Les tables pliantes Winglet sur roulettes vous permettent de reconfigurer les espaces de réunion multifonctionnels avec le panneau / tableau Flipper.

Mit den abklappbaren Winglet-Tischen auf rollen können Sie die multifunktionalen Besprechungsräume zusammen mit dem Flipper-Display / der Tafel neu konfigurieren.

Las mesas plegables Winglet sobre ruedas le permiten reconfigurar los espacios de reunión multifuncionales junto con la pantalla / pizarra Flipper.

accessori • accessories • accessoires • Zubehör • accesorios

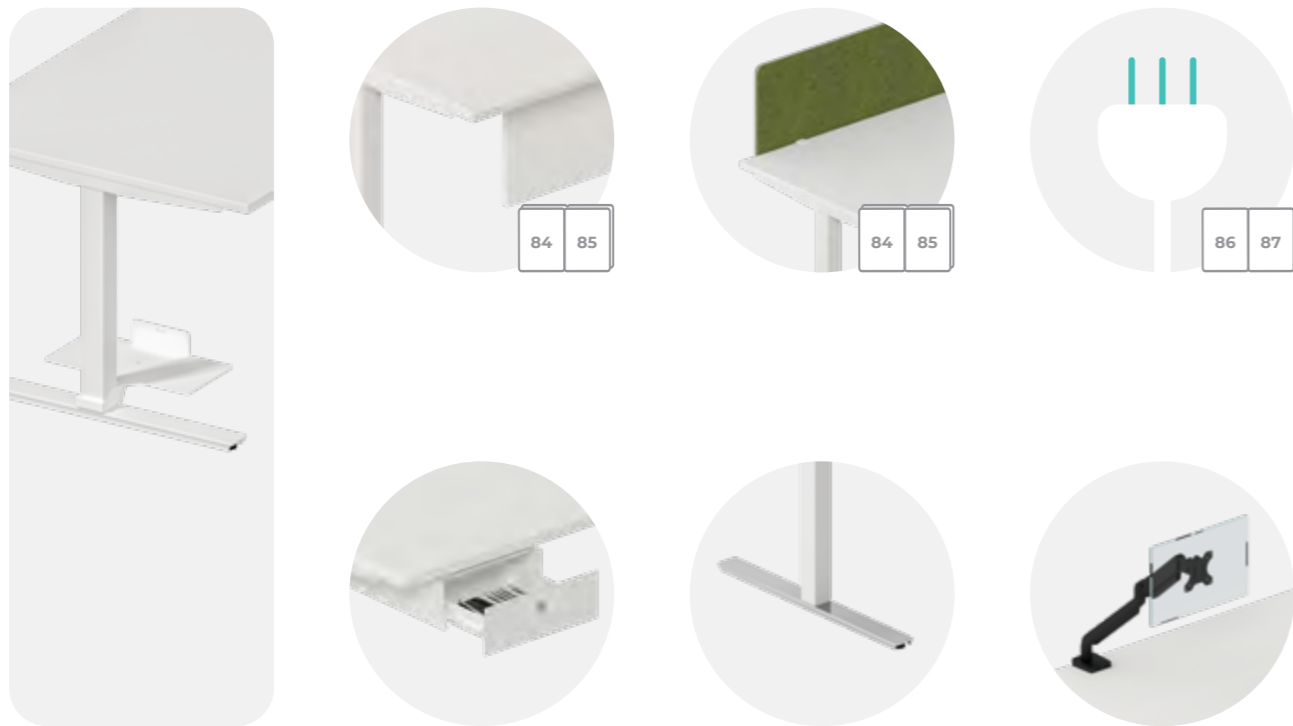

Winglet: accessori • accessories • accessoires • Zubehör • accesorios

Winglet e



finiture • finishes • finitions • Ausführungen • acabados

numero finiture, number of finishes, numéro de finitions, Anzahl der Ausführungen, numero de acabados

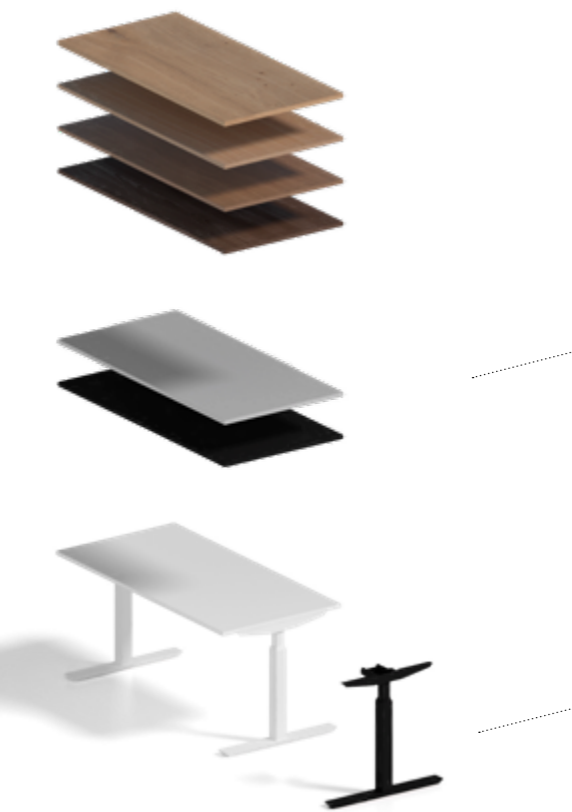

7

melaminico, melamine, mélamine, melamin, melamina



*h: 30 mm

metallo, metal, métal, Metall, metal



3

Winglet push



h: 65 ÷ 85 cm



Regolazione in altezza ogni 2 cm
Height adjustment every 2 cm
Réglage hauteur tous les 2 cm
Höhenverstellung alle 2 cm
Ajuste de altura cada 2 cm



Winglet

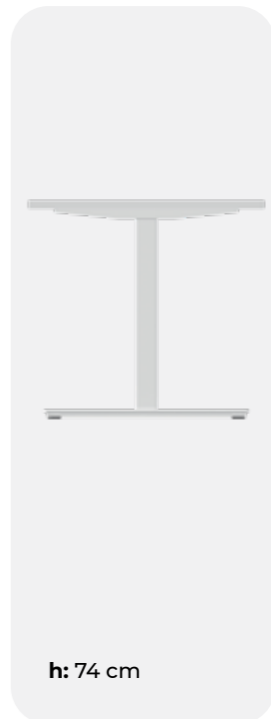

h: 74 cm

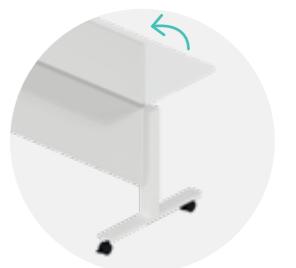

elettrificazione • electrification • électrification • Elektrifizierung • electrificación

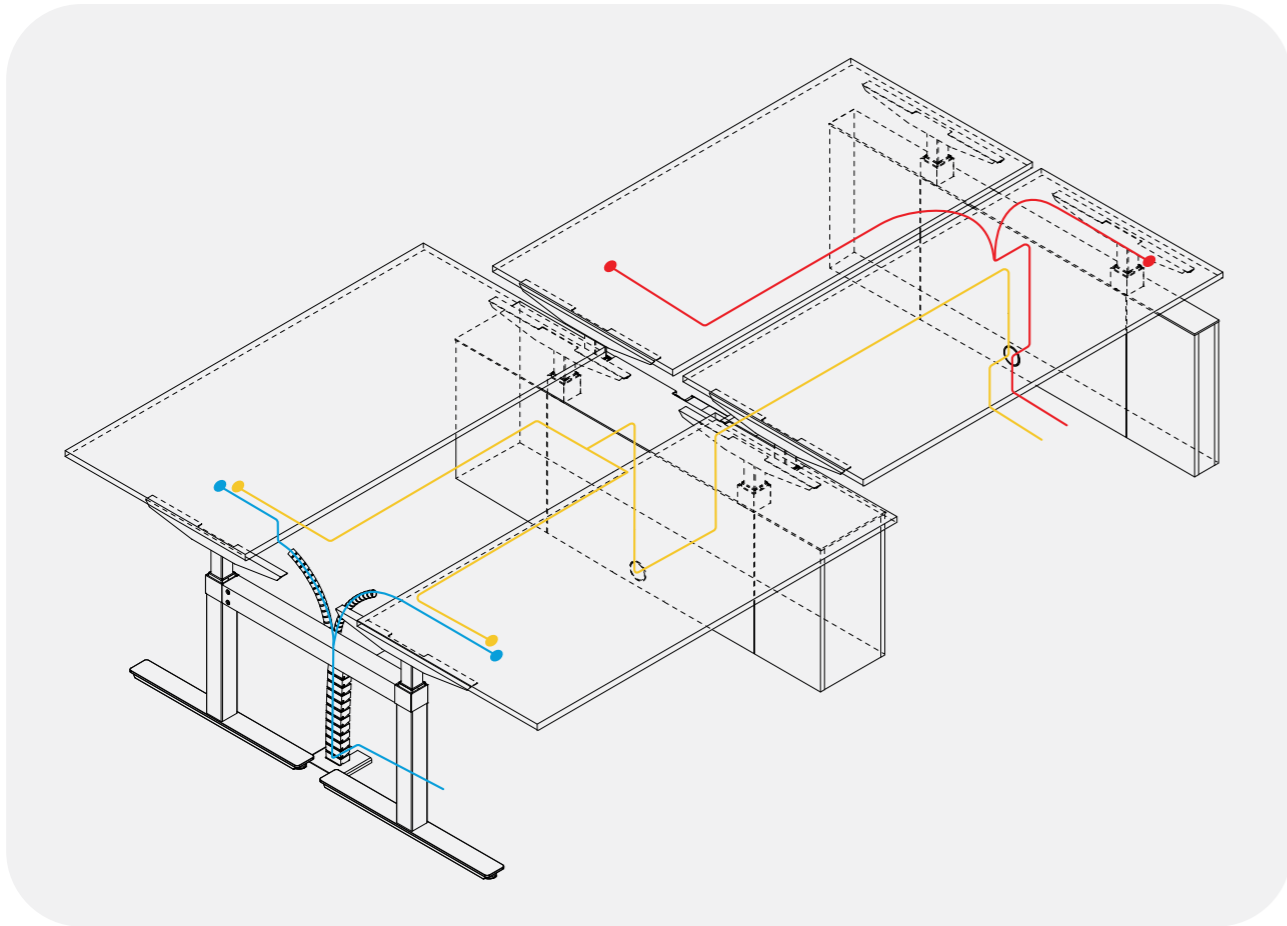
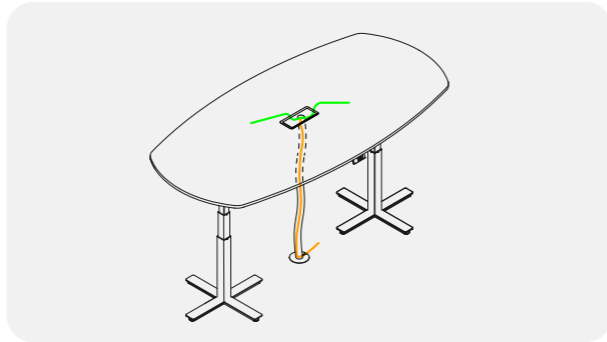
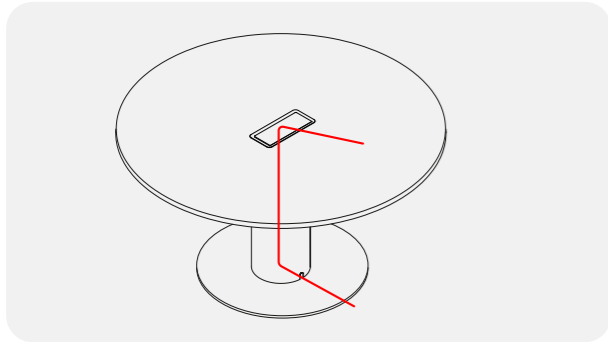
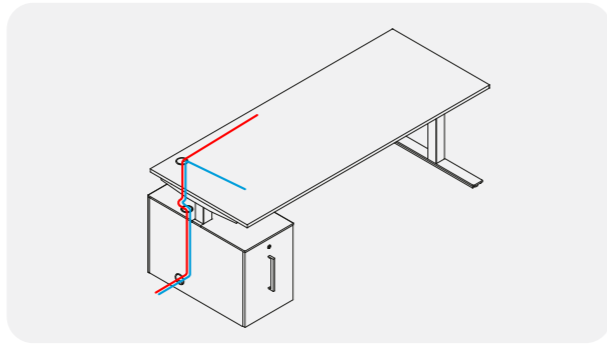
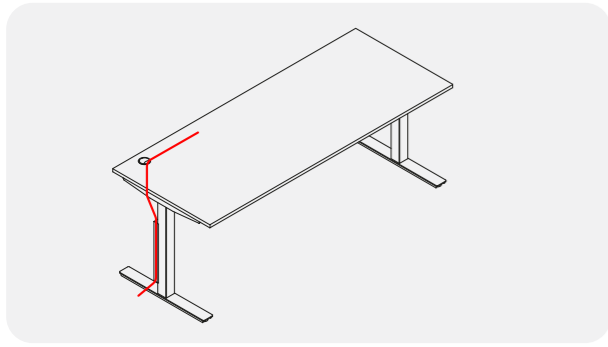

componibilità • modularity • composable • Kombinierbarkeit • componibilidad

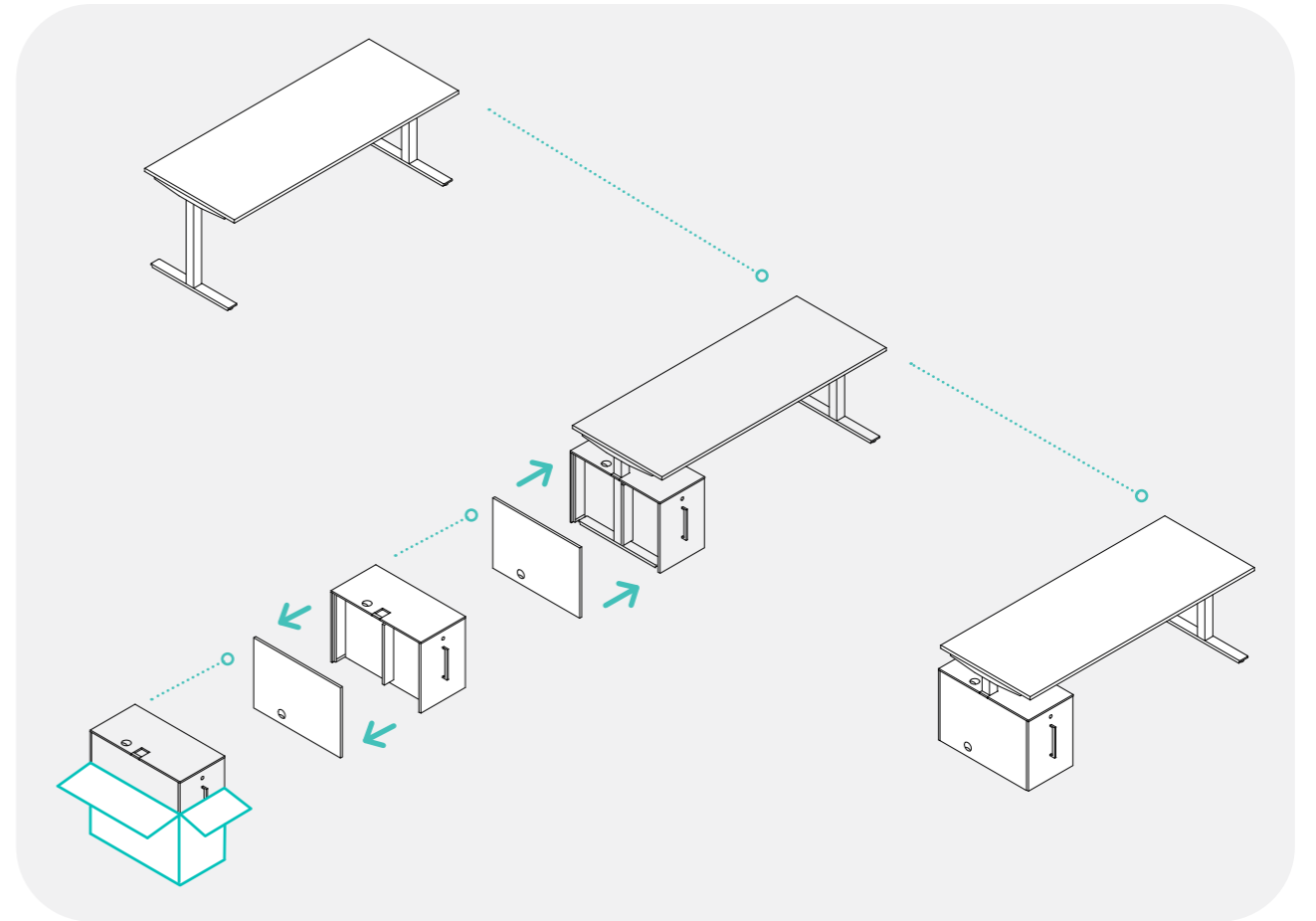
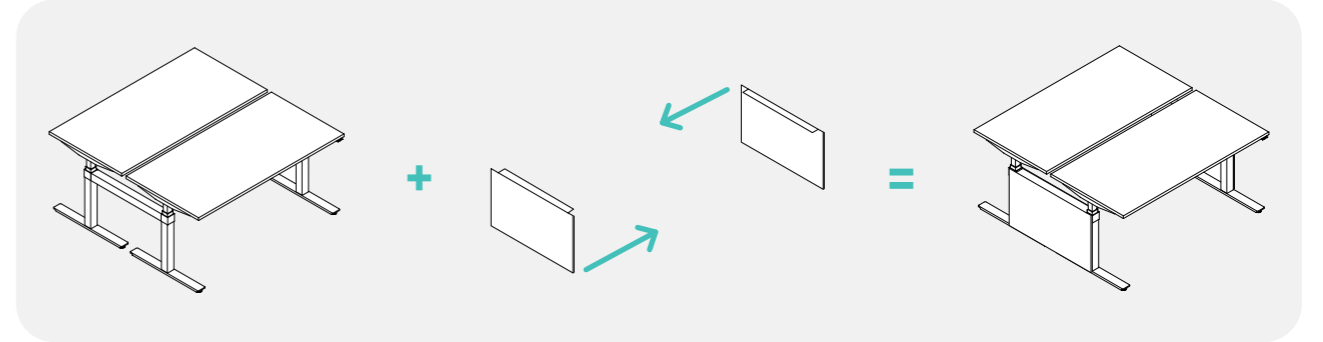
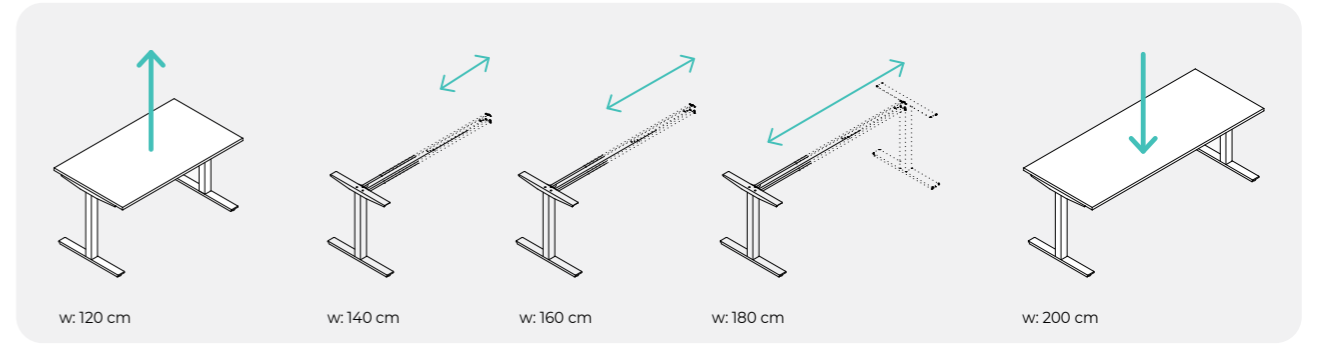

Winglet e

h 65÷130 cm	h 56 cm		h 65÷130 cm	h 75÷132 cm
w 140÷200 cm d 80 cm	w 40 cm d 80 cm	w 160 cm d 46 cm	w 80 - 100 cm d 60 cm	w 122,5 cm d 60 cm
h 65÷130 cm	h 62÷127 cm			
w 140÷180 cm d 164 cm	w 140÷180 cm d 164 cm	w 140÷180 cm d 164 cm	w 220 cm d 120 cm	w 200 - 240 cm d 100 cm
w 240 cm d 120 cm	w 200 cm d 104 cm	w d 70 cm	∅ 80 - 100 cm	

Winglet push

h: 65÷85 cm				
w 80÷200 cm d 60 - 80 cm	w 80 - 100 cm d 60 cm	w 100÷140 cm d 60 cm	w 140÷200 cm d 124 - 164 cm	w 289÷409 cm d 124 - 164 cm

Winglet

h 74 cm		h 56 cm		h 74 cm
w 120÷180 cm d 80 cm	w 80÷200 cm d 60 - 80 cm	w 40 cm d 80 cm	w 160 cm d 46 cm	w 120÷200 cm d 60 - 80 cm
h 74 cm				
w 100 - 120 cm d 60 cm	w 80 - 100 - 120* cm d 60 cm	w 80÷200 cm d 60 - 80 cm	w 140÷200 cm d 124 - 164 cm	w 280÷400 cm d 124 - 164 cm
∅ 80÷120 cm	w d 70 cm	220cm 120cm	w 200 - 240 cm d 100 cm	w 200 - 240 cm d 100 cm
w 240 cm d 120 cm	w 200 cm d 104 cm	w 200 cm d 104 cm	w 200 cm d 104 cm	∅ 140 - 160 cm

h 40 cm	h 74 cm	h 105 cm	h 40-74-105 cm
∅ 60 cm	∅ 80=120 cm	∅ 60 cm	w d 70 cm

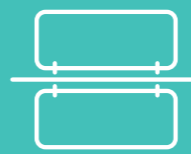

78 - 79
schermi e gonne ·
screens and modesty panels · écrans et voiles de fond ·
Sichtschutzpaneele und Knieraumblende · pantallas y faldones



83 - 87
elettrificazione · electification ·
électrification · Elektrifizierung · electrificación

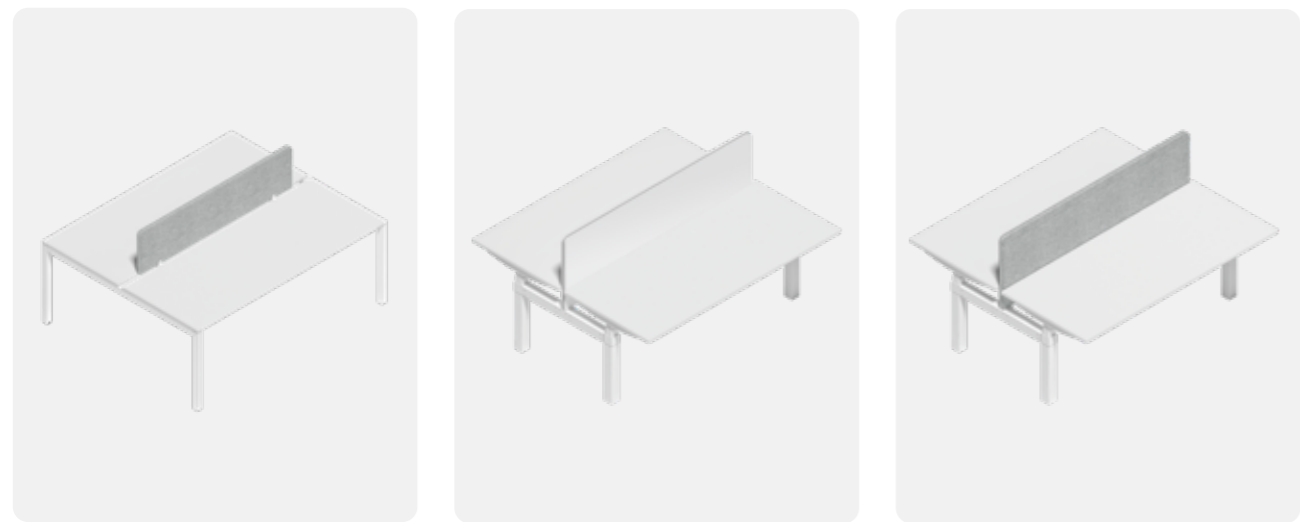
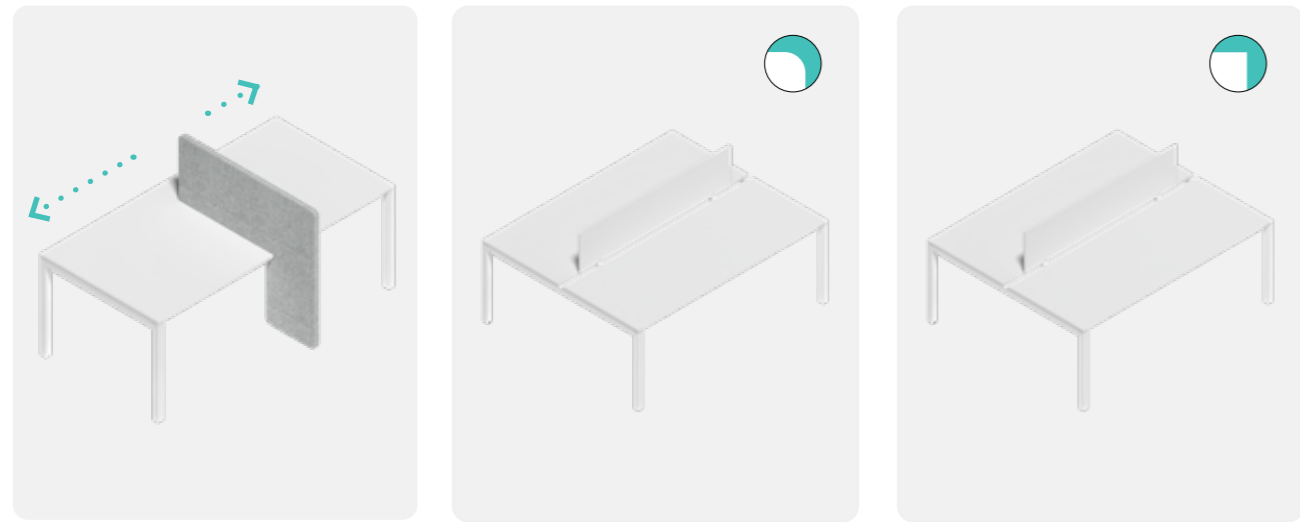
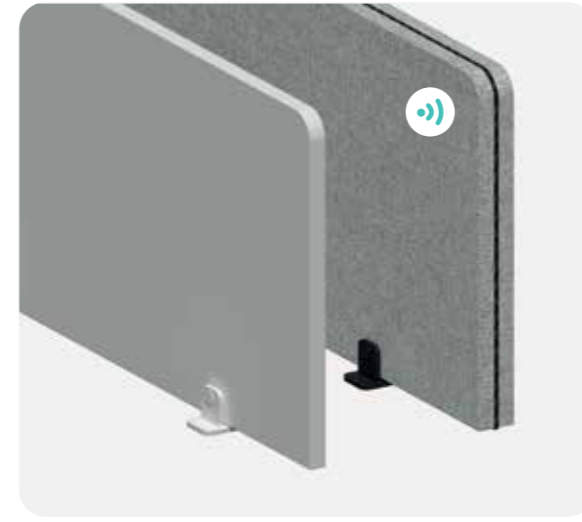

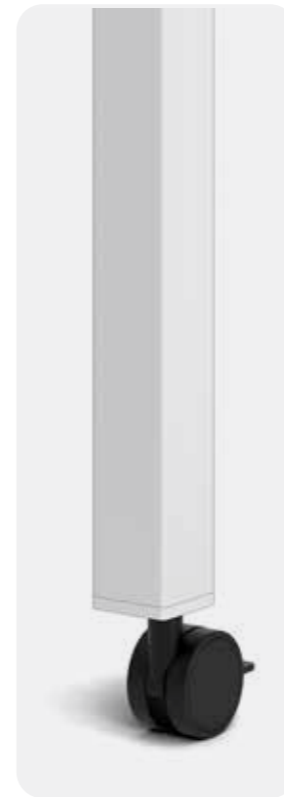

h 62 ÷ 86 cm

Regolazione in altezza ogni 2 cm
Height adjustment every 2 cm
Réglage hauteur tous les 2 cm
Höhenverstellung alle 2 cm
Ajuste de altura cada 2 cm



ø 8 cm
h 10 cm



ø 27 cm
h 40 cm



elettrificazione sopra piano, desktop electrification, électrification au-dessus du plateau,
Elektrifizierung über den Tisch, electrificación encima de la tapa

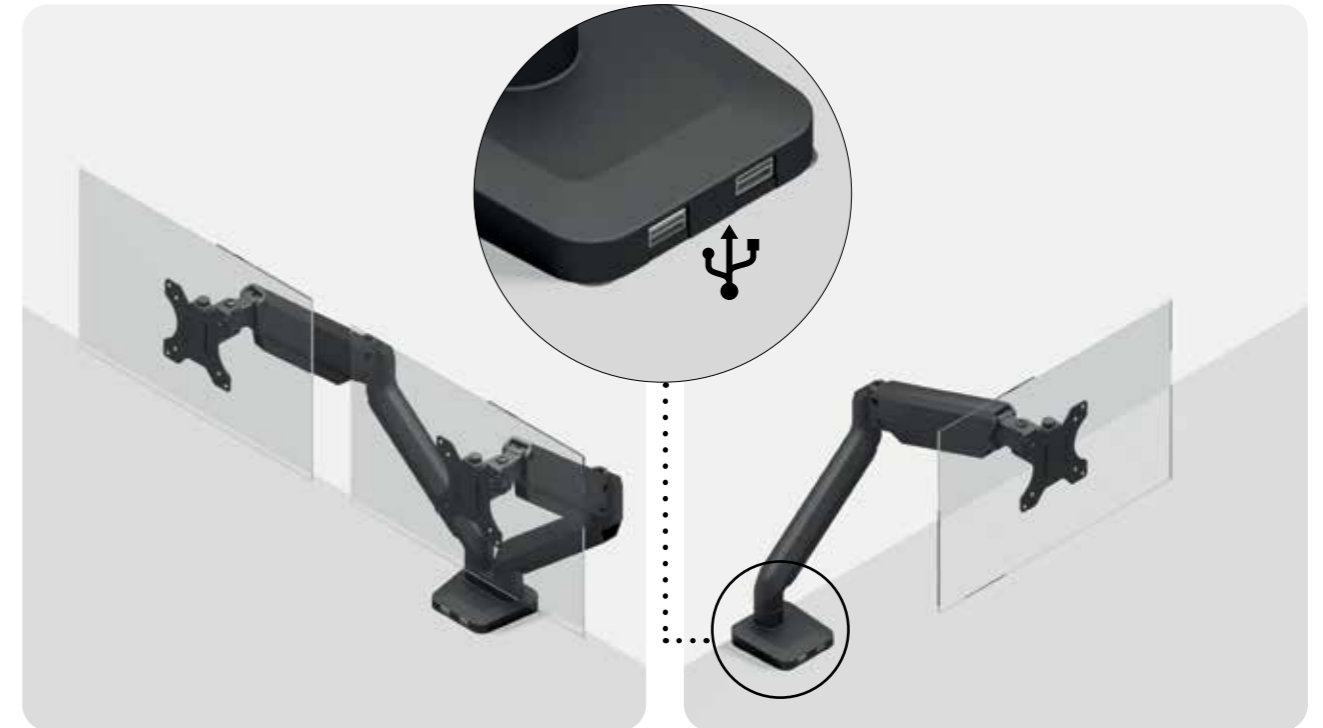



elettrificazione sopra piano, desktop electrification, électrification au-dessus du plateau,
Elektrifizierung über den Tisch, electrificación encima de la tapa



plastica, plastic, plastique,
Plastick, plástico



plastica, plastic, plastique,
Plastick, plástico
laccato opaco, lacquered matt, laqué mat
matt lackiert, lacado mate

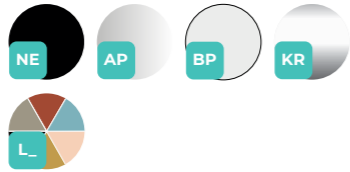

metallo, metal, métal,
metall, metal



plastica, plastic, plastique,
Plastick, plástico



plastica, plastic, plastique,
Plastick, plástico



metallo, metal, métal,
metall, metal



plastica, plastic, plastique,
Plastick, plástico
laccato opaco, lacquered matt, laqué mat
matt lackiert, lacado mate



metallo, metal, métal,
metall, metal



plastica, plastic, plastique,
Plastick, plástico





elettrificazione sotto piano, under desktop electrification, électrification sous plateau,
Elektrifizierung unter den Tisch, electrificación debajo de la tapa

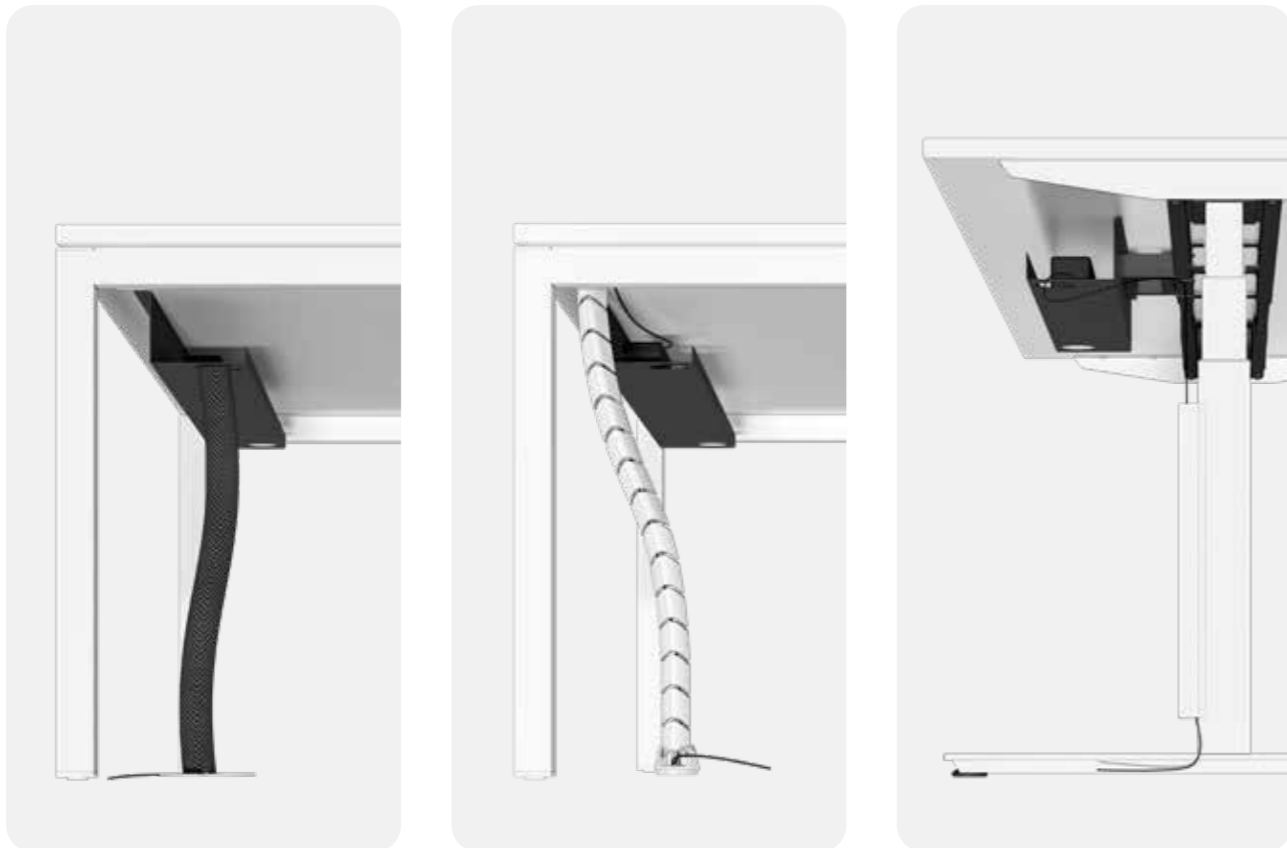

cestelli portacavi, cable holder baskets, paniers porte-câbles,
Kabelwanne, bandejas portacables

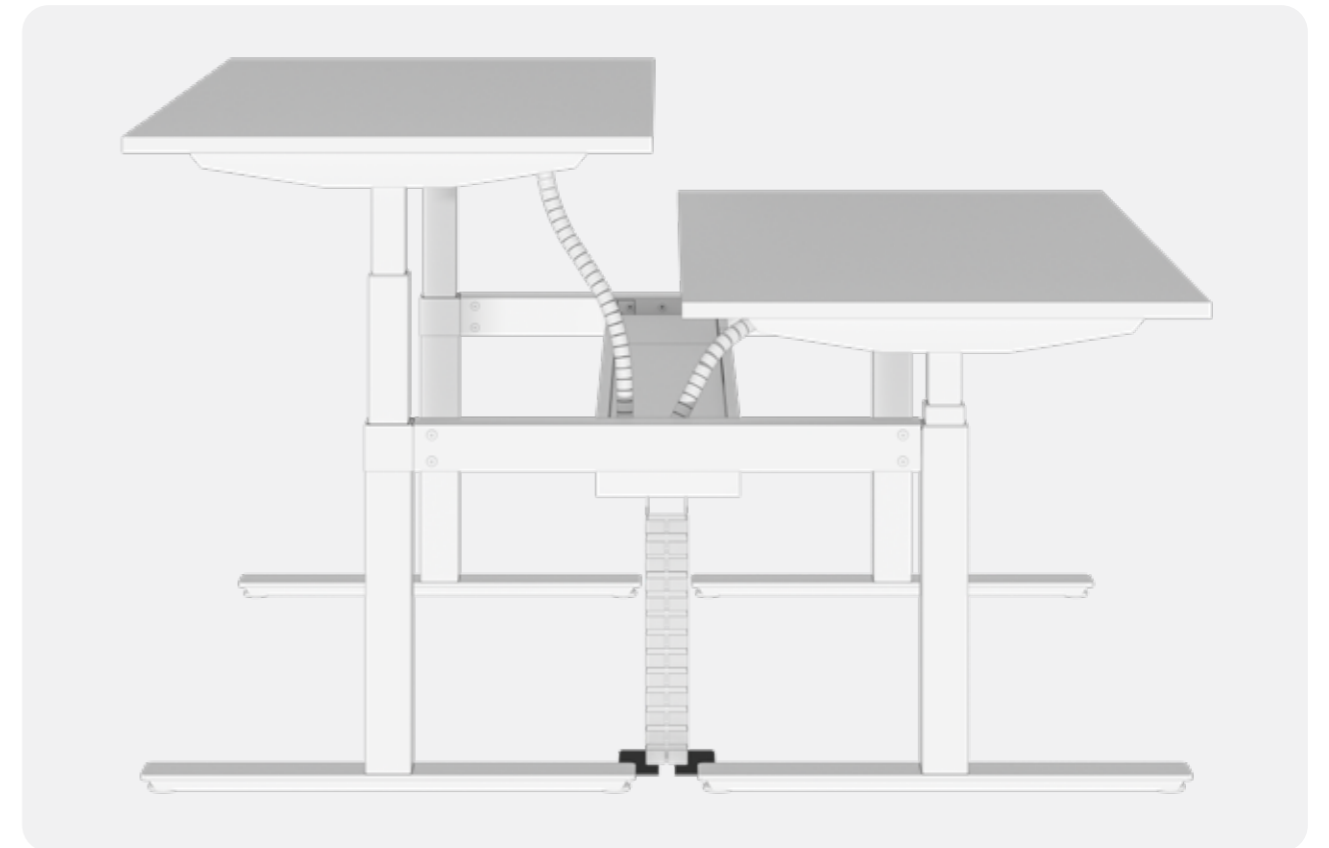
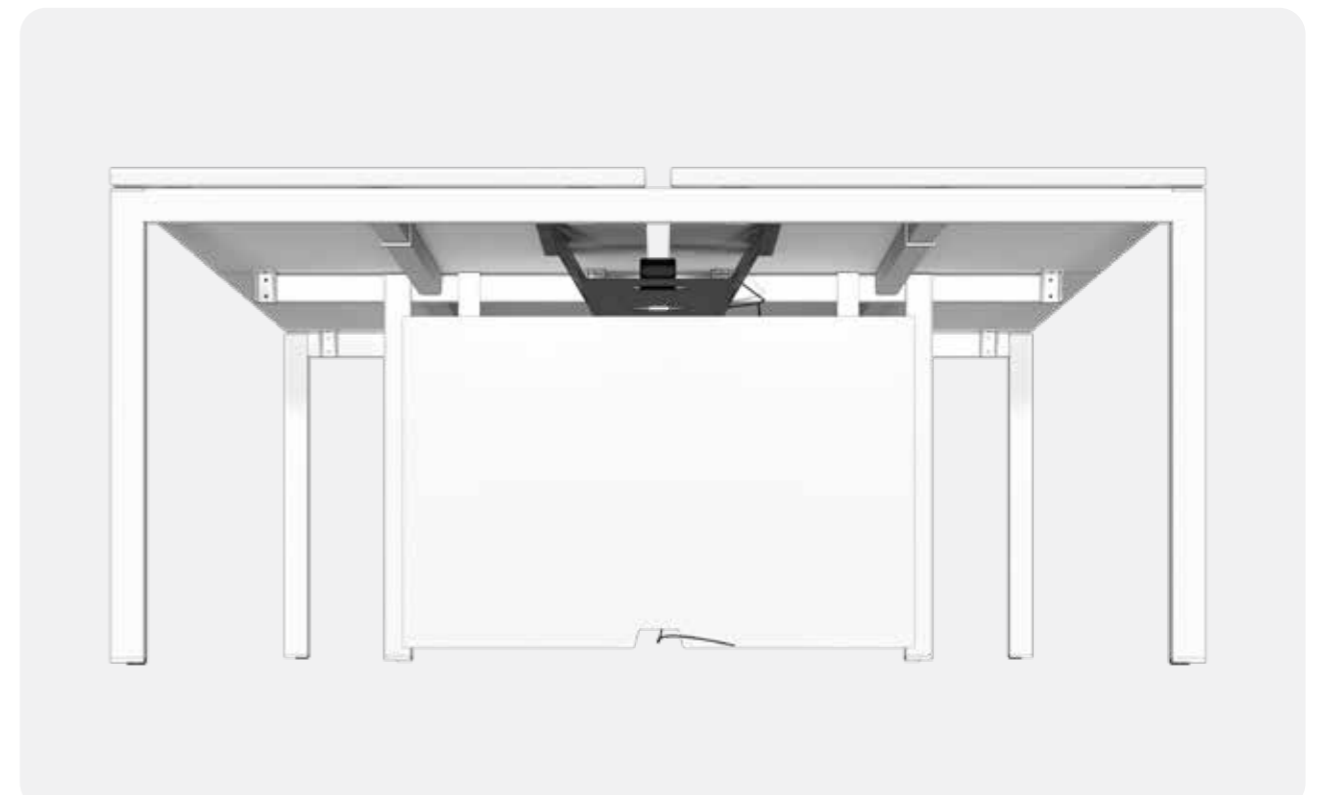

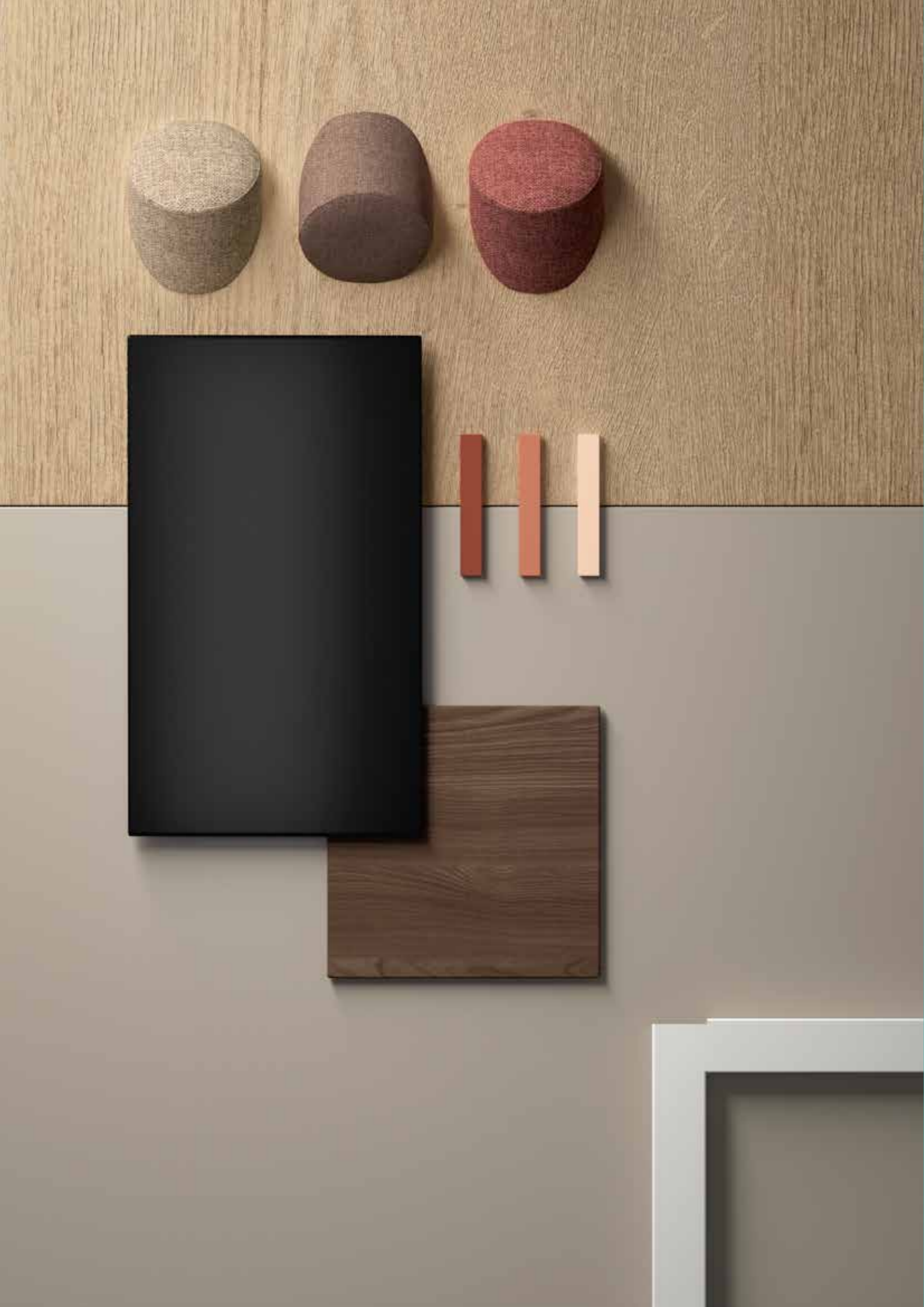

melaminico • melamine • mélamine • melamin • melamina

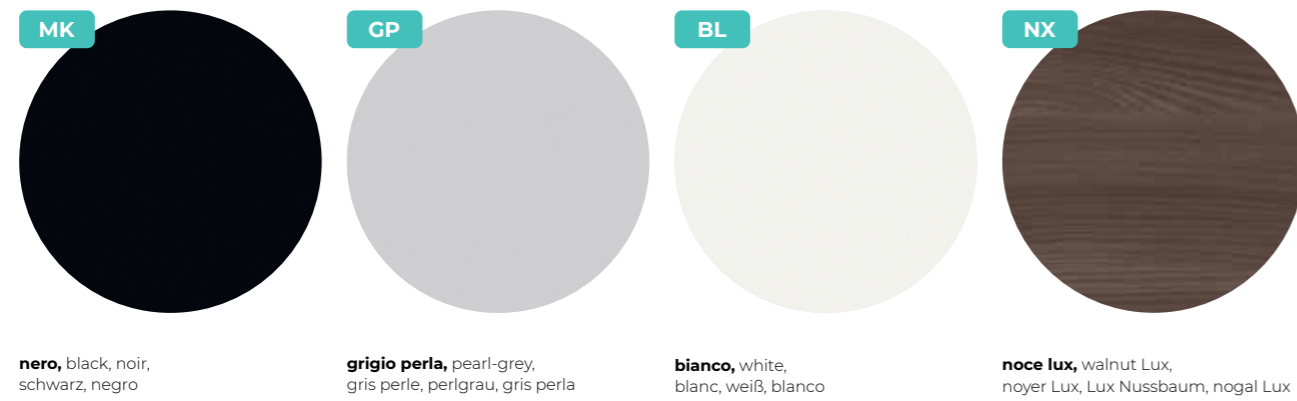

nero, black, noir, schwarz, negro

grigio perla, pearl-grey, gris perle, perlgrau, gris perla

bianco, white, blanc, weiß, blanco

noce lux, walnut Lux, noyer Lux, Lux Nussbaum, nogal Lux



noce canaletto, canaletto walnut, noyer canaletto, Canaletto Nussbaum, nogal canaletto

rovere naturale, natural oak, chêne naturel, Natur Eiche, roble natural

rovere anticato, traditional oak, chêne vieilli, Eiche Antik, roble antiguo

RA - Superficie antibatterica
Antibacterial surface
surface antibactérienne,
Antibakterielle Oberfläche
superficie antibacteriana

legno • veneer • bois • holz • maderá



rovere naturale, natural oak, chêne naturel, Natur Eiche, roble natural

strutture metalliche • metal structures • structures métalliques • metallgestelle • estructuras metálicas

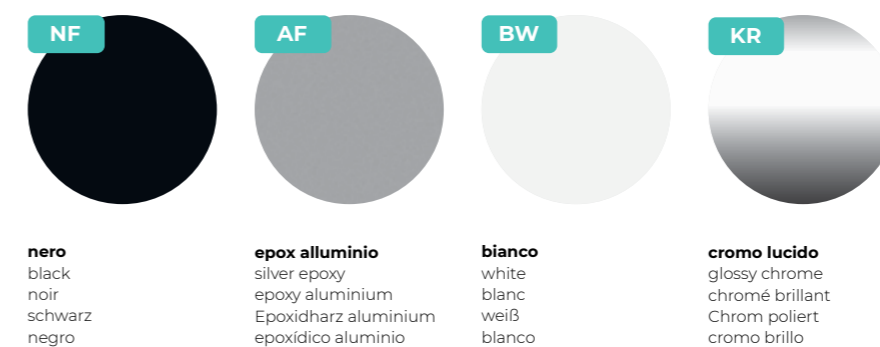

nero
black
noir
schwarz
negro

epox alluminio
silver epoxy
epoxy aluminium
Epoxidharz aluminium
epoxidico aluminio

bianco
white
blanc
weiß
blanco

cromo lucido
glossy chrome
chromé brillant
Chrom poliert
cromo brillo

laccato opaco • lacquered matt • laqué mat • matt lackiert • lacado mate

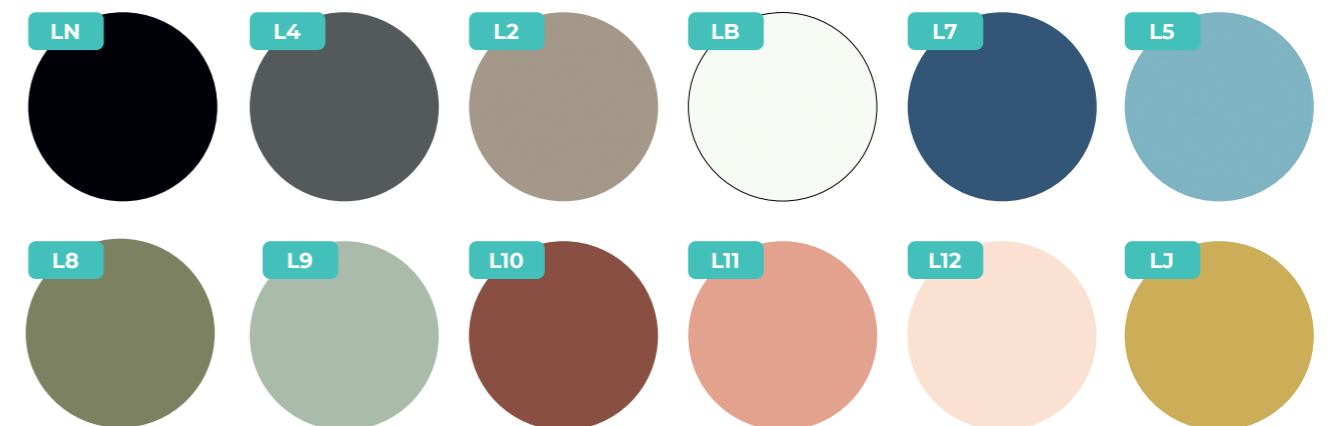

tessuto • fabric • tissu • stoff • tejido

MIRAGE

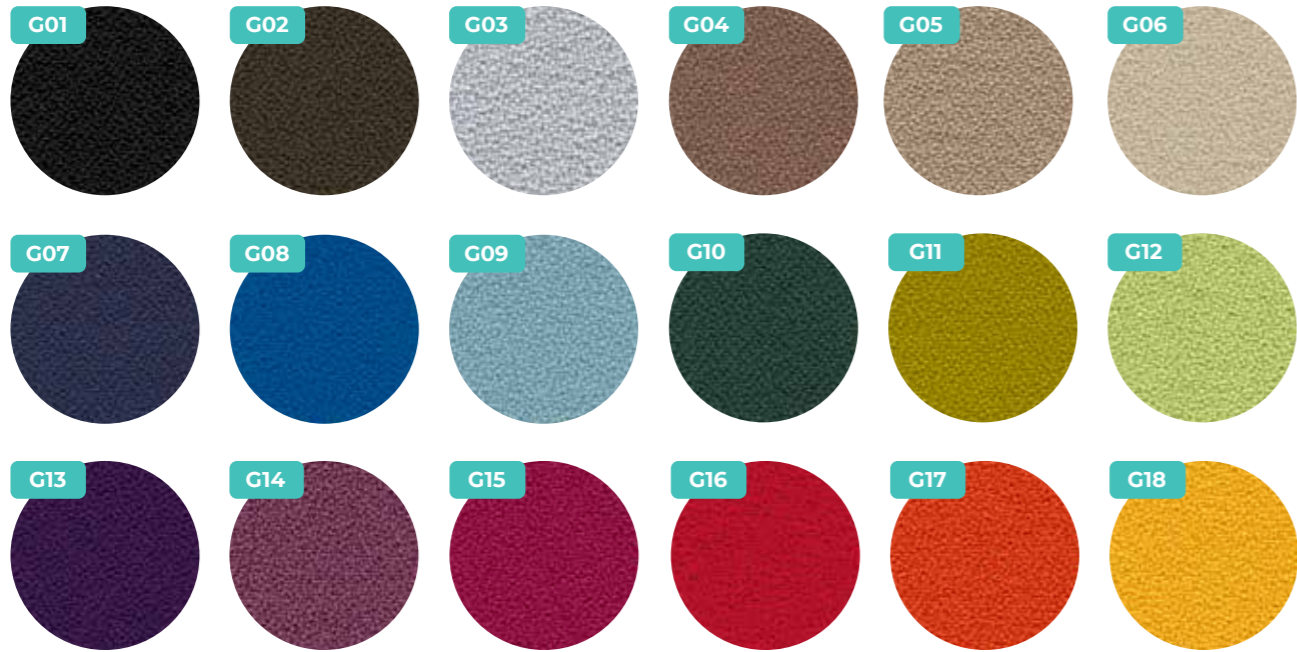

NEMI MELANGE



FENICE

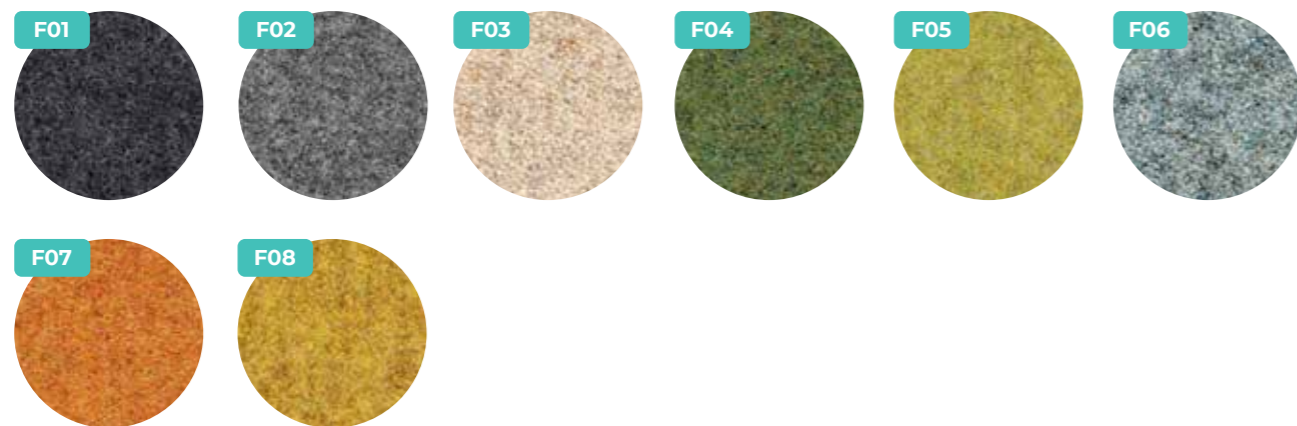

CONVERT MEL 4000





selezione delle materie prime • selection of raw materials • sélection des matières premières • Auswahl der Rohstoffe • seleccion de materias primas

attenzione e cura nella scelta dei materiali: Legno impiallacciato / vetro / pelle / tessuto / vetro ceramica • attention and care in the selection of materials: veneer / glass / leather / fabric / vitro ceramic • attention et soin dans la sélection des matériaux: bois plaquage/verre/peau/tissu/vitro-céramique • Aufmerksamkeit und Sorgfalt bei der Auswahl der Materialien: Holz furnier / Glas / Leder / Stoff / Glaskeramik • atención y cuidado en la selección de los materiales: madera pintada/vidrio/piel/tejido/vidrio ceramica



produzione certificata, ecologica e rispettosa dell'ambiente e dell'utente • certified production, green environmentally and user friendly • production certifiée, écologique et respectueuse de l'environnement et de l'individu • Zertifizierte, umweltfreundliche Produktion mit großer Respekt für Umwelt und Nutzer • Produccion certificada, ecologica y respetuosa del ambiente y del usuario

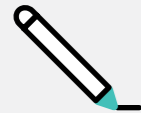

progettazione • space planning • projets • Projekte • proyectos



capacità di produzione industriale • industrial production ability • capacité de production industrielle • industrielle Produktionskapazität • capacidad de producción industrial



garanzia e disponibilità dei componenti • warranty and availability of components • garantie et disponibilité des composants • Garantie und Verfügbarkeit der Komponenten • garantía y disponibilidad de los componentes



esperienza • experience • expérience • Erfahrung • experiencia



articoli speciali • special items • articles spéciaux • Sonderanfertigungen • artículos especiales

il nostro sistema di produzione segue standard avanzati per la cura dell'individuo e della natura • our production system follows advanced standards for individual and nature care • notre système de production suit des standards avancées pour le soin de l'individu et de la nature • Unser Produktionsverfahren fortschrittlichen Standards für den Schutz von Mensch und Natur • nuestro sistema de producción sigue estandar avanzados para el cuidado al individuo y a la naturaleza



California 93120
Compliant for Formaldehyde Phase 2



The mark of responsible forestry

I nostri prodotti in melaminico possono essere forniti FSC® su richiesta cliente • Our melamine products can be FSC® supplied upon customer request • Nos produits en mélaminé peuvent être fournis certifiés FSC® sur demande du client • Unsere Melamin-Produkte können auf Anfrage des Kunden in FSC® geliefert werden • Nuestros productos de melamina pueden ser suministrados FSC® a petición del cliente

la nostra azienda opera con l'obiettivo primario di garantire prodotti che raggiungano un corretto equilibrio tra sostenibilità ambientale e design • our Company operates with the primary objective of guaranteeing products that achieve a correct balance between, environmental sustainability and design • notre société a comme objectif principal celui de garantir des produits qui atteignent un juste équilibre entre, durabilité environnementale et design • Unsere Firma hat sich als Hauptziel die Garantie von Produkten gesetzt, welche ein korrektes Gleichgewicht zwischen Umweltverträglichkeit und Design erzielen • nuestra empresa trabaja con el objetivo primario de garantizar productos que alcanzan un correcto equilibrio entre sostenibilidad ambiental y de diseño



imballi costituiti da materiali facilmente separabili e riciclabili • recyclable and easy to dispose packagings • emballages constitués de matériaux facilement séparables et recyclables • Die Verpackungen ermöglichen ein schnelles Trennen und Wiederverwertung von Materialien • embalaje constituido de materiales simplemente separables y reciclables



TSCA Title VI
Compliant

riduzione di formaldeide e di sostanze tossiche e potenzialmente dannose • low formaldehyde emission, low toxic and potentially harmful substances • réduction de formaldéhyde et des substances toxiques et potentiellement nocives • Reduzierung von Formaldehyd und Giftstoffe, die eine potentielle Gefahr darstellen • reducción de formaldehido y sustancias tóxicas y que pueden ser dañinas



estensione del ciclo di vita dei prodotti • product life extension • extension du cycle de vie du produit • Erweiterung der Produktlebensdauer • extension del ciclo de vida de los productos



produzione di arredi a ridotto impatto ambientale • furniture products with reduced environmental impact • production de mobiliers à impact environnemental réduit • Produktion von Einrichtungen mit niedriger Umweltbelastung • producción de mobiliario con reducido impacto ambiental



facilità di disassemblaggio per favorire la riconfigurabilità, il riutilizzo o il riciclo • easy reconfiguration, reuse or recycling • simplicité de démontage pour favoriser la reconfiguration, la réutilisation ou le recyclage • Leichte Zerlegung um Rekonfigurierbarkeit, Wiederverwendung oder Recycling zu ermöglichen • facilidad de desensamblaje para facilitar el configurar de nuevo, reutilizar y reciclar

Edizione Luglio 2023 - Particolari tecnici ed estetici possono essere modificati senza preavviso. Le rese cromatiche non sono vincolanti così come la fedeltà della riproduzione. Dati, misure e dettagli devono essere verificati con il listino.

July 2023 Edition - Technical and aesthetic details can be modified without notice. Colour rendering may differ. Check the data, measures and details on the price list.

Édition Juillet 2023 - Les détails techniques et esthétiques peuvent être modifiés sans préavis. Le rendu chromatique n'est pas contractuel, ainsi que la fidélité de la reproduction. Les données, les mesures et les détails doivent être vérifiés avec le tarif.

Ausgabe Juli 2023 - Technische und ästhetische Details könnten ohne Voranmeldung geändert werden. Die Echtheit der Farbwiedergabe ist nicht verbindlich. Daten, Maße und Details sind in der Preisliste zu überprüfen.

Edición Julio 2023 - Los detalles técnicos y estéticos pueden ser modificados sin preaviso. Los rendimientos de color y la fidelidad de la reproducción no son vinculantes. Los datos, las medidas y los detalles deben ser verificados con la tarifa de precios.

 **bralco**

s25

project: gherardi architetti
images: gherardi architetti, nerokubo
printed: grafiche antiga

thanks to: Artemide, Davide Groppi, Vibia, Zumtobel

Bralco Srl - Via Luigi Einaudi, 1 - 31058 Susegana TV - Italy
T +39 0438 43 77
info@bralco.it - bralco.it



